

ph HORN ph



boehlerit

BOEHLERIT DREHEN
BOEHLERIT TURNING

2020/2021



**DAS WERKZEUG
HORN TOOLS**

Die neuen Kataloge von HORN – Maßstäbe für Ihre Produktivität

Von der Einzelteil- bis zur Serienfertigung, bei Standard- oder Sonderanwendungen: Unsere Werkzeuge bieten Ihnen schnelle, wirtschaftliche und qualitativ hochwertige Lösungen.

Die aktuellen HORN-Kataloge sind in folgende Themen aufgegliedert:

- Stechdrehen
- Supermini und Mini Innenbearbeitung
- Modulare Haltersysteme
- Hochharte Schneidstoffe
- Frässysteme
- Bohren und Reiben
- VHM-Fräswerkzeuge
- Boehlerit Drehen
- Boehlerit Fräsen

Bei der Wahl der individuellen Schnittparameter unterstützen Sie unsere Tabellen mit praxiserprobten Erfahrungswerten. Nutzen Sie das Fachwissen unserer Innen- und Außendienstmitarbeiter. Denn wir kennen den Markt und haben für Ihre Aufgaben und Herausforderungen die passenden Lösungen.



Lothar Horn
Geschäftsführer
Paul Horn GmbH



Markus Horn
Geschäftsführer
Paul Horn GmbH



Matthias Rommel
Geschäftsführer
Paul Horn GmbH

New catalogues from HORN - benchmarks for productivity

From single part to series production, for standard or special applications: our tools offer you fast, economical and high quality solutions.

The current HORN catalogues are divided into the following sections:

- Grooving
- Supermini & Mini Internal Machining
- Modular Holder Systems
- Ultra Hard Cutting Materials
- Milling Systems
- Drilling / Reaming
- Solid Carbide Mills
- Milling Catalogue Boehlerit
- Turning Catalogue Boehlerit

To assist you when choosing cutting parameters, our tables provide proven empirical values. Take advantage of the expertise of our office staff and sales engineers, because we know the market well and have the right solutions for your applications and challenges.



Lothar Horn
CEO
Paul Horn GmbH

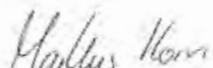

Markus Horn
CEO
Paul Horn GmbH



Matthias Rommel
CEO
Paul Horn GmbH

Inhaltsübersicht

Content

Drehen	Turning	4
Programmübersicht	Range of tools	6
Technologievorteile, Kundennutzen	Technological advantages, customer benefits	15
Spanformstufengeometrien	Chip groove geometries	16
Schnitttiefen der Spanformstufengeometrien	Depth of cut for chip groove geometries	24
Sortenübersicht, Schneidstoffsorten	Grade overview, cutting materials	25
ISO-Bezeichnungssysteme	ISO-designation systems	28
Wendeschneidplatten	Indexable inserts	34
Klemmhalter	Tool holders	63
Technische Hinweise	Technical hints	114
Dreh-Bohr-Werkzeug Pentatec®	Turning-Drilling-Tool Pentatec®	135
Fünf Bearbeitungsoperationen, ein Werkzeug	Five machining operations, one tool	137
Technische Hinweise	Technical hints	138
Bezeichnungssystem	Designation system	140
Halterprogramm	Tool holders	141
Wendeschneidplatten	Indexable inserts	142
Sortenübersicht	Grade overview	143
Schnittparameter	Cutting parameters	144
Gewindedrehen	Thread Turning	149
Wendeschneidplatten	Indexable inserts	151
Klemmhalter	Tool holders	166
Technische Hinweise	Technical hints	169
Anhang	Attachment	177
Werkstoff-Vergleichstabelle	Comparison of material standards	180
Vergleich ISO- zu ANSI-Kennzeichnung	Comparison ISO- and ANSI-designation	188
Härte Vergleichstabelle	Hardness comparison table	191

Nachdruck, auch auszugsweise, ist nur mit unserer Zustimmung gestattet. Alle Rechte vorbehalten. Irrtümer, Satz- oder Druckfehler berechtigen nicht zu irgendwelchen Ansprüchen. Abbildungen, Ausführungen und Maße entsprechen dem neuesten Stand bei Herausgabe dieses Kataloges. Technische Änderungen müssen vorbehalten sein. Die bildliche Darstellung der Produkte muss nicht in jedem Falle und in allen Einzelheiten dem tatsächlichen Aussehen entsprechen. This publication may not be reprinted in whole or part without our express permission. All right reserved. No rights may be derived from any errors in content or from typographical or typesetting errors. Diagrams, features and dimensions represent the current status on the date of issue of this catalogue. We reserve the right to make technical changes. The visual appearance of the products may not necessarily correspond to the actual appearance in all cases or in every detail.

Drehen Turning

phi HORN phi

boehlerit



Drehen	Turning	
Programmübersicht	Range of tools	
Werkzeuge und Wendeschneidplatten für die Außenbearbeitung	Tools and indexable inserts for external machining	6
Werkzeuge und Wendeschneidplatten für die Innenbearbeitung	Tools and indexable inserts for internal machining	12
Technologievorteile, Kundennutzen	Technological advantages, customer benefits	15
Spanformstufengeometrien	Chip groove geometries	16
Schnitttiefe der Spanformgeometrien	Depth of cut for chipbreaker	24
Sortenübersicht	Grade overview	25
ISO-Bezeichnungssysteme	ISO-designation systems	28
Wendeschneidplatten	Indexable inserts	34
Klemmhalter	Tool holders	63
Technische Hinweise	Technical hints	
Klemmhalter-Spannsysteme	Tool holder – clamping systems	114
Wahl des Spannsystems	Selecting a clamping system	115
Wahl der Werkzeuge für die Innenbearbeitung	Selecting tools for internal machining	116
Wahl der Wendeplattengröße	Selecting the indexable insert size	117
Wahl der Wendeplattenform	Selecting the indexable insert shape	118
Schlichtbearbeitung	Finishing	120
Formeln für die Drehbearbeitung	Formulas for machining work	122
Maßnahmen bei Drehproblemen	Options against machining problems	123
Schnittwertempfehlungen	Cutting data recommendations	124

Schnitttrichtung Cutting direction	Anstellwinkel Setting angle	Werkzeug Tool	Bestellbezeichnung Ordering Code	Seiten Pages
	72,5°	Klemmhalter Tool holder Wendeplatte Indexable inserts	BM51576 XCGT...	89
	95°	Klemmhalter Tool holder Wendeplatte Indexable inserts	DCLNR/L CN...	64
	93°	Klemmhalter Tool holder Wendeplatte Indexable inserts	DDJNR/L DN...	64
	45°	Klemmhalter Tool holder Wendeplatte Indexable inserts	DSSNR/L SN...	64
	90°	Klemmhalter Tool holder Wendeplatte Indexable inserts	DTJNR/L 16 TN...	65
	95°	Klemmhalter Tool holder Wendeplatte Indexable inserts	DWLNR/L WN...	65
	45°	Klemmhalter Tool holder Wendeplatte Indexable inserts	MSSNR/L SN...	66
	93°	Klemmhalter Tool holder Wendeplatte Indexable inserts	MTJNR/L TN...	66
	95°	Klemmhalter Tool holder Wendeplatte Indexable inserts	MWLNR/L WN...	67

Schnitttrichtung Cutting direction	Anstellwinkel Setting angle	Werkzeug Tool	Bestellbezeichnung Ordering Code	Seiten Pages
	75°	Klemmhalter Tool holder Wendepplatte Indexable inserts	PCBNR/L CN...	68
	75°	Klemmhalter Tool holder Wendepplatte Indexable inserts	PCKNR/L CN...	68
	95°	Klemmhalter Tool holder Wendepplatte Indexable inserts	PCLNR/L CN...	68
		Klemmhalter mit Innenkühlung Tool holder with coolant Wendepplatte Indexable inserts	PCLNR/L CN	94
	93°	Klemmhalter Tool holder Wendepplatte Indexable inserts	PDJNR/L DN...	69
		Klemmhalter mit Innenkühlung Tool holder with coolant Wendepplatte Indexable inserts	PDJNR/L DN...	94
	93°	Klemmhalter Tool holder Wendepplatte Indexable inserts	PDJNR/L 14 DN... 14...	69
	63°	Klemmhalter Tool holder Wendepplatte Indexable inserts	PDNNR/L DN...	69
	-	Klemmhalter Tool holder Wendepplatte Indexable inserts	PRDCN RC...	70
	-	Klemmhalter Tool holder Wendepplatte Indexable inserts	PRGCR/L RC...	70
	-	Klemmhalter Tool holder Wendepplatte Indexable inserts	PRSCR/L RC...	70

Schnitttrichtung Cutting direction	Anstellwinkel Setting angle	Werkzeug Tool	Bestellbezeichnung Ordering Code	Seiten Pages
	75°	Klemmhalter Tool holder	PSBNR/L	71
		Wendepplatte Indexable inserts	SN...	
	45°	Klemmhalter Tool holder	PSDNN	71
		Wendepplatte Indexable inserts	SN...	
	75°	Klemmhalter Tool holder	PSKNR/L	71
		Wendepplatte Indexable inserts	SN...	
	45°	Klemmhalter Tool holder	PSSNR/L	72
		Wendepplatte Indexable inserts	SN...	
	90°	Klemmhalter Tool holder	PTFNR/L	73
		Wendepplatte Indexable inserts	TN...	
	90°	Klemmhalter Tool holder	PTGNR/L	73
		Wendepplatte Indexable inserts	TN...	
	60°	Klemmhalter Tool holder	PTTNR/L	73
		Wendepplatte Indexable inserts	TN...	
	95°	Klemmhalter Tool holder	PWLNRL/L	74
		Wendepplatte Indexable inserts	WN...	
		Klemmhalter mit Innenkühlung Tool holder with coolant	PWLNRL/L	94
		Wendepplatte Indexable inserts	WN...	

Schnitttrichtung Cutting direction	Anstellwinkel Setting angle	Werkzeug Tool	Bestellbezeichnung Ordering Code	Seiten Pages
	90°	Klemmhalter Tool holder	SCFCR/L	75
		Wendeplatte Indexable inserts	CC...	
	95°	Klemmhalter Tool holder	SCLCR/L	76
		Wendeplatte Indexable inserts	CC...	92
		Klemmhalter mit Innenkühlung Tool holder with coolant	SCLCR/L	
Wendeplatte Indexable inserts	CC...			
	50°	Klemmhalter Tool holder	SCMCN	76
		Wendeplatte Indexable inserts	CC...	
	75°	Klemmhalter Tool holder	SCRCL/L	77
		Wendeplatte Indexable inserts	CC...	
	45°	Klemmhalter Tool holder	SCSCR/L	77
		Wendeplatte Indexable inserts	CC...	
	90°	Klemmhalter Tool holder	SDACR/L	78
		Wendeplatte Indexable inserts	DC...	
	107,5°	Klemmhalter Tool holder	SDHCR/L	78
		Wendeplatte Indexable inserts	DC...	

Schnitttrichtung Cutting direction	Anstellwinkel Setting angle	Werkzeug Tool	Bestellbezeichnung Ordering Code	Seiten Pages
	93°	Klemmhalter Tool holder	SDJCR/L	78
		Wendepplatte Indexable inserts	DC...	
	93°	Klemmhalter mit Innenkühlung Tool holder with coolant	SDJCR/L	92
		Wendepplatte Indexable inserts	DC...	
	62,5°	Klemmhalter Tool holder	SDNCN	79
		Wendepplatte Indexable inserts	DC...	
	-	Klemmhalter Tool holder	SRDCN	80
		Wendepplatte Indexable inserts	RC...	
	-	Klemmhalter Tool holder	SRGCR/L	80
		Wendepplatte Indexable inserts	RC...	
	75°	Klemmhalter Tool holder	SSBCR/L	81
		Wendepplatte Indexable inserts	SC...	
	45°	Klemmhalter Tool holder	SSDCN	81
		Wendepplatte Indexable inserts	SC...	
	75°	Klemmhalter Tool holder	SSKCR/L	81
		Wendepplatte Indexable inserts	SC...	
	45°	Klemmhalter Tool holder	SSSCR/L	82
		Wendepplatte Indexable inserts	SC...	
	90°	Klemmhalter Tool holder	STACR/L	83
		Wendepplatte Indexable inserts	TC...	

Schnitttrichtung Cutting direction	Anstellwinkel Setting angle	Werkzeug Tool	Bestellbezeichnung Ordering Code	Seiten Pages
	90°	Klemmhalter Tool holder	STCCN	83
		Wendepplatte Indexable inserts	TC...	
	90°	Klemmhalter Tool holder	STFCR/L	83
		Wendepplatte Indexable inserts	TC...	
	90°	Klemmhalter Tool holder	STGCR/L	84
		Wendepplatte Indexable inserts	TC...	
	107,5°	Klemmhalter Tool holder	SVHBR/L	85
		Wendepplatte Indexable inserts	VB...	
	107,5°	Klemmhalter Tool holder	SVHCR/L	85
		Wendepplatte Indexable inserts	VC...	
	93°	Klemmhalter Tool holder	SVJBR/L	86
		Wendepplatte Indexable inserts	VB...	
	93°	Klemmhalter Tool holder	SVJCR/L	86
		Wendepplatte Indexable inserts	VC...	
		Klemmhalter mit Innenkühlung Tool holder with coolant	SVJCR/L	93
	72,5°	Wendepplatte Indexable inserts	VC...	
		Klemmhalter Tool holder	SVVBN	87
	72,5°	Wendepplatte Indexable inserts	VB...	
		Klemmhalter Tool holder	SVVCN	87
	72,5°	Wendepplatte Indexable inserts	VC...	
		Klemmhalter Tool holder	SVVCN	87

**Programmübersicht
Range**

Werkzeuge und Wendepplatten für die Außenbearbeitung
Tool holders and indexable inserts for external machining



Schnitttrichtung Cutting direction	Anstellwinkel Setting angle	Werkzeug Tool	Bestellbezeichnung Ordering Code	Seiten Pages
	100°	Klemmhalter Tool holder Wendepplatte Indexable inserts	SVZCR/L VC...	87
	95°	Klemmhalter Tool holder Wendepplatte Indexable inserts	SWLCR/L WC...	88

**Programmübersicht
Range**

Werkzeuge und Wendepplatten für die Innenbearbeitung
Tool holders and indexable inserts for internal machining

Schnitttrichtung Cutting direction	Anstellwinkel Setting angle	Werkzeug Tool	Bestellbezeichnung Ordering Code	Seiten Pages
	95°	Klemmhalter Tool holder Wendepplatte Indexable inserts	PCLNR/L CN...	98
	95°	Klemmhalter Tool holder Wendepplatte Indexable inserts	29629/29529 CN...	98
	93°	Klemmhalter Tool holder Wendepplatte Indexable inserts	PDUNR/L DN...	99
	93°	Klemmhalter Tool holder Wendepplatte Indexable inserts	PDUNR/L 14 DN...	99
	75°	Klemmhalter Tool holder Wendepplatte Indexable inserts	PSKNR/L SN...	100
	90°	Klemmhalter Tool holder Wendepplatte Indexable inserts	PTFNR/L TN...	100

Schnitttrichtung Cutting direction	Anstellwinkel Setting angle	Werkzeug Tool	Bestellbezeichnung Ordering Code	Seiten Pages
	95°	Klemmhalter Tool holder Wendeplatte Indexable inserts	PWLNRL/ WN...	101
	90°	Klemmhalter Tool holder Wendeplatte Indexable inserts	SCFCR/L CC...	102
	95°	Klemmhalter Tool holder Wendeplatte Indexable inserts	SCLCR/L CC...	103
	107,5°	Klemmhalter Tool holder Wendeplatte Indexable inserts	SDQCR/L DC...	105
	93°	Klemmhalter Tool holder Wendeplatte Indexable inserts	SDUCR/L DC...	106
	90°	Klemmhalter Tool holder Wendeplatte Indexable inserts	STFCR/L TC...	108
	95°	Klemmhalter Tool holder Wendeplatte Indexable inserts	SVLCR/L VC...	108
	5°	Klemmhalter Tool holder Wendeplatte Indexable inserts	SVOCR/L VC...	108
	107,5°	Klemmhalter Tool holder Wendeplatte Indexable inserts	SVQCR/L VC...	109
	93°	Klemmhalter Tool holder Wendeplatte Indexable inserts	SVUBR/L VB...	109

Schnitttrichtung Cutting direction	Anstellwinkel Setting angle	Werkzeug Tool	Bestellbezeichnung Ordering Code	Seiten Pages
	93°	Klemmhalter Tool holder Wendepplatte Indexable inserts	SVUCR/L VC...	109
	72,25°	Klemmhalter Tool holder Wendepplatte Indexable inserts	SVVCR/L VC...	110
	113°	Klemmhalter Tool holder Wendepplatte Indexable inserts	SVXCR/L VC...	110
	5°	Klemmhalter Tool holder Wendepplatte Indexable inserts	SV95CR/L	111
	95°	Klemmhalter Tool holder Wendepplatte Indexable inserts	SWLCR/L WC...	112
	92°	Klemmhalter Tool holder Wendepplatte Indexable inserts	S74P TP...	113

<p>Im "Spankanal" optimierte Spanleitstufe mit besonders weichem Schnitt Chip breaker optimised in the chip channel; remarkably soft cut</p>		<p>Geringere Reibung ergibt geringere Neigung zum Kolkverschleiß und daher längere Standzeiten</p>	<p>Reduced friction therefore less cratering, resulting in prolonged tool life</p>
<p>Größe des Eckenradius und Anwendungsbereiches mitgepresst Corner radius dimension and application range are pressed along in the process</p>		<p>Einfache Zuordnung der Wendeplatten</p>	<p>Simple allocation of indexable inserts</p>
<p>Neuentwickelte Spanformer Newly developed chip breaker</p>		<p>Optimaler Spanbruch</p>	<p>Optimized chip breaking</p>
<p>Schneidkantenbereich in der Mitte stabilisiert, optimierte Mikrogeometrie Cutting edge area stabilised in the middle; optimised microgeometry</p>		<p>Keine Ausbrüche bei Spanschlag - Drehen gegen die Schulter</p>	<p>No breakage at chip impact - turning against the shoulder</p>
<p>Spanschlag-Protector Chip impact protector</p>		<p>Keine Ausbrüche durch Spanschlag beim Drehen gegen die Schulter</p>	<p>No chippings of the cutting edge caused by chip impact when turning against the shoulder</p>
<p>Spezielle Spangeometrie mit auf Kleinteile abgestimmten Eckenradien Special chip geometry with corner radius for little parts</p>		<p>Guter Spanbruch und weicher Schnitt</p>	<p>Good chip breakage and smooth cut</p>
<p>Positive Makrogeometrie und scharfe Mikrogeometrie Positive macrogeometry and sharp microgeometry</p>		<p>Guter Spanbruch auf schwererspanbaren Werkstoffen z.B.: (Superlegierungen)</p>	<p>Good chip breaking characteristics on materials that are notoriously difficult to machine e.g. (superalloys)</p>
<p>Optimierte Gradientenhartmetalle Optimised gradient carbides</p>		<p>Speziell auf den jeweiligen Anwendungsfall abgestimmte Hartmetallsorten für besondere Sicherheit</p>	<p>Carbide gradient grades tailored to specific applications for extra-high safety levels</p>
<p>Dicke MT-CVD-Schicht Thick MT-CVD layer</p>		<p>Bewährte Nanolockverbindungen. Besonders dicke MT-CVD-Schichten bei LCP15T und LCP25T gewährleisten Standzeitsteigerungen bis zu 60 %</p>	<p>Proven Nanolock compound. LCP15T and LCP25T with especially thick MT-CVD layer allow 60 % increase of tool life</p>

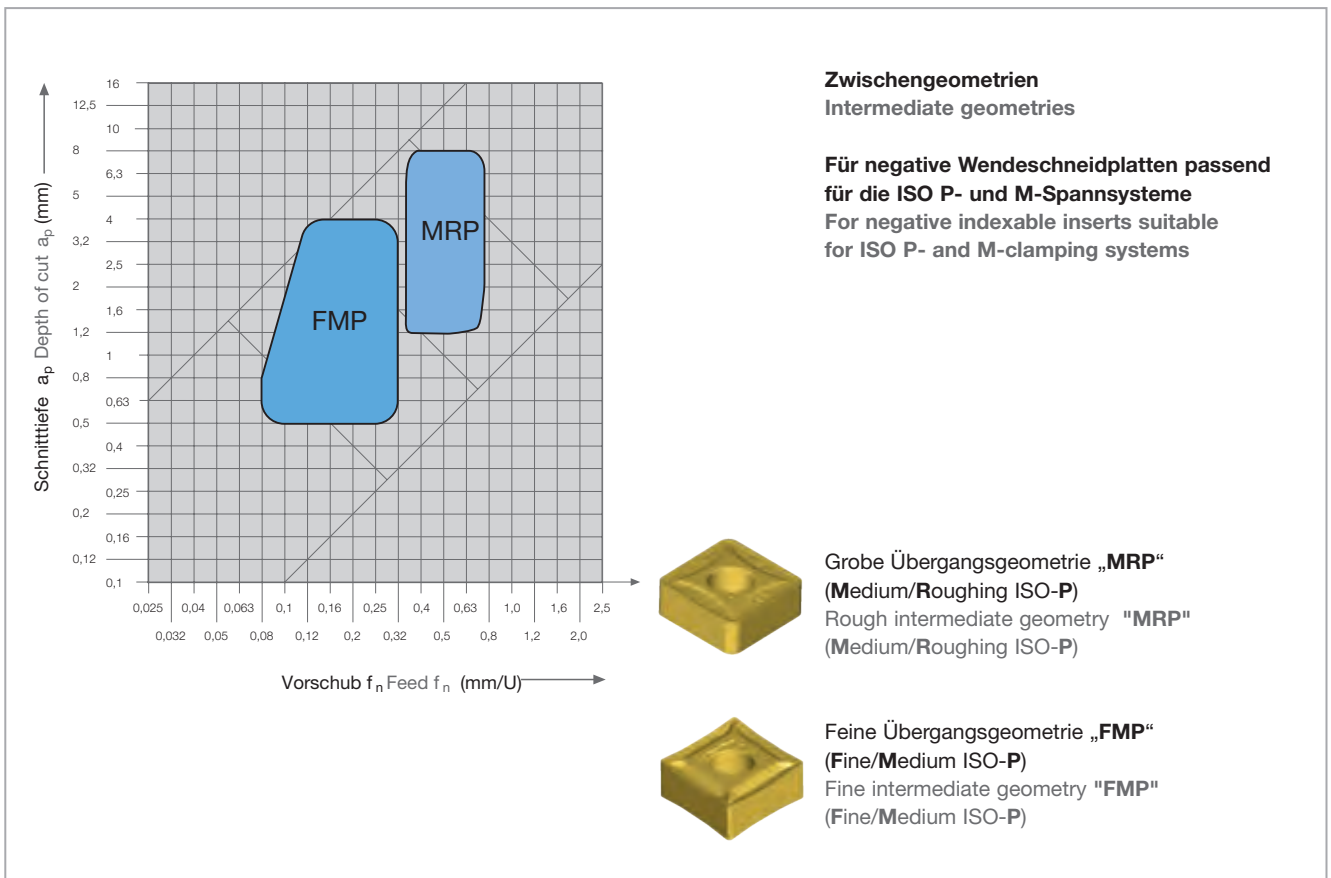
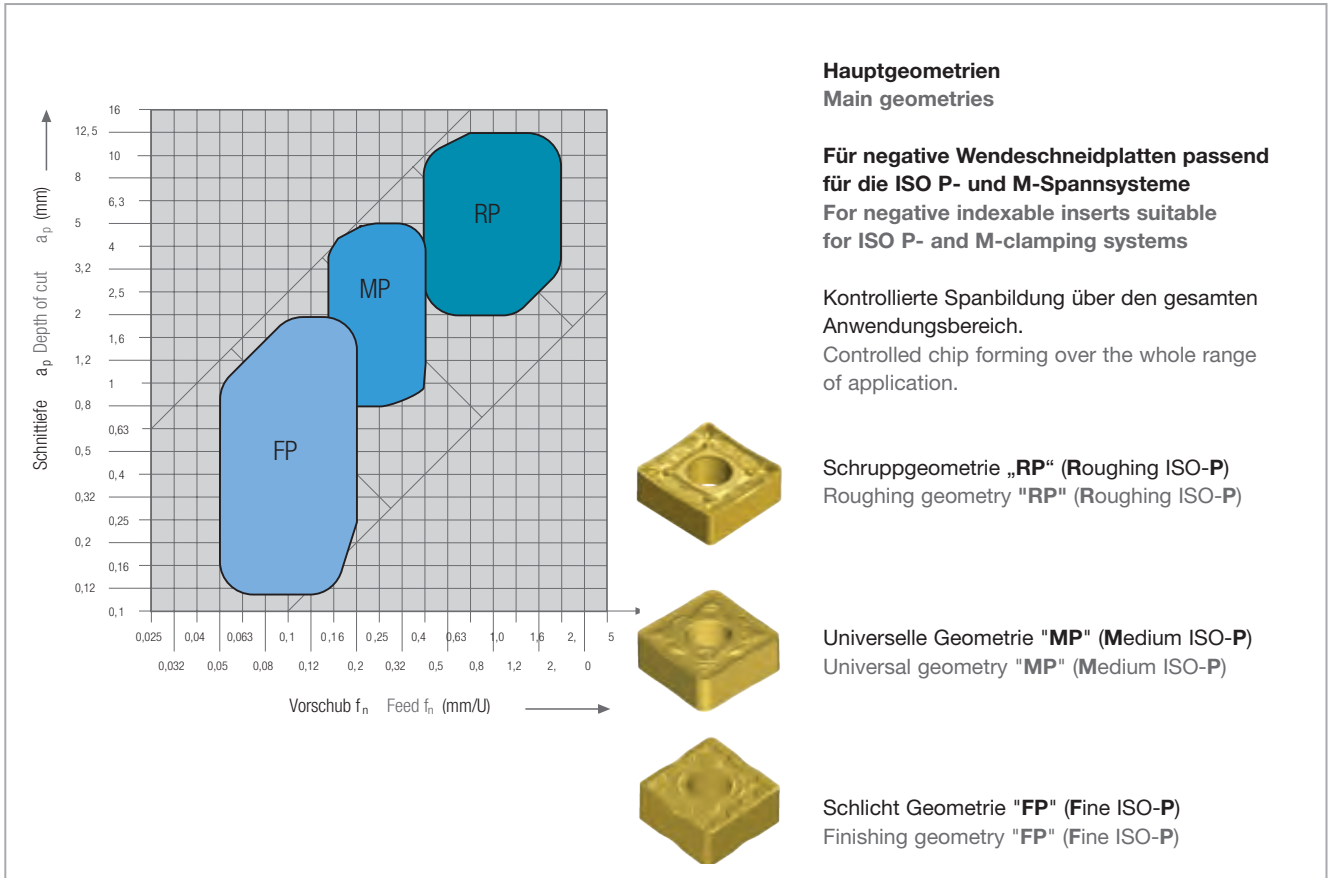

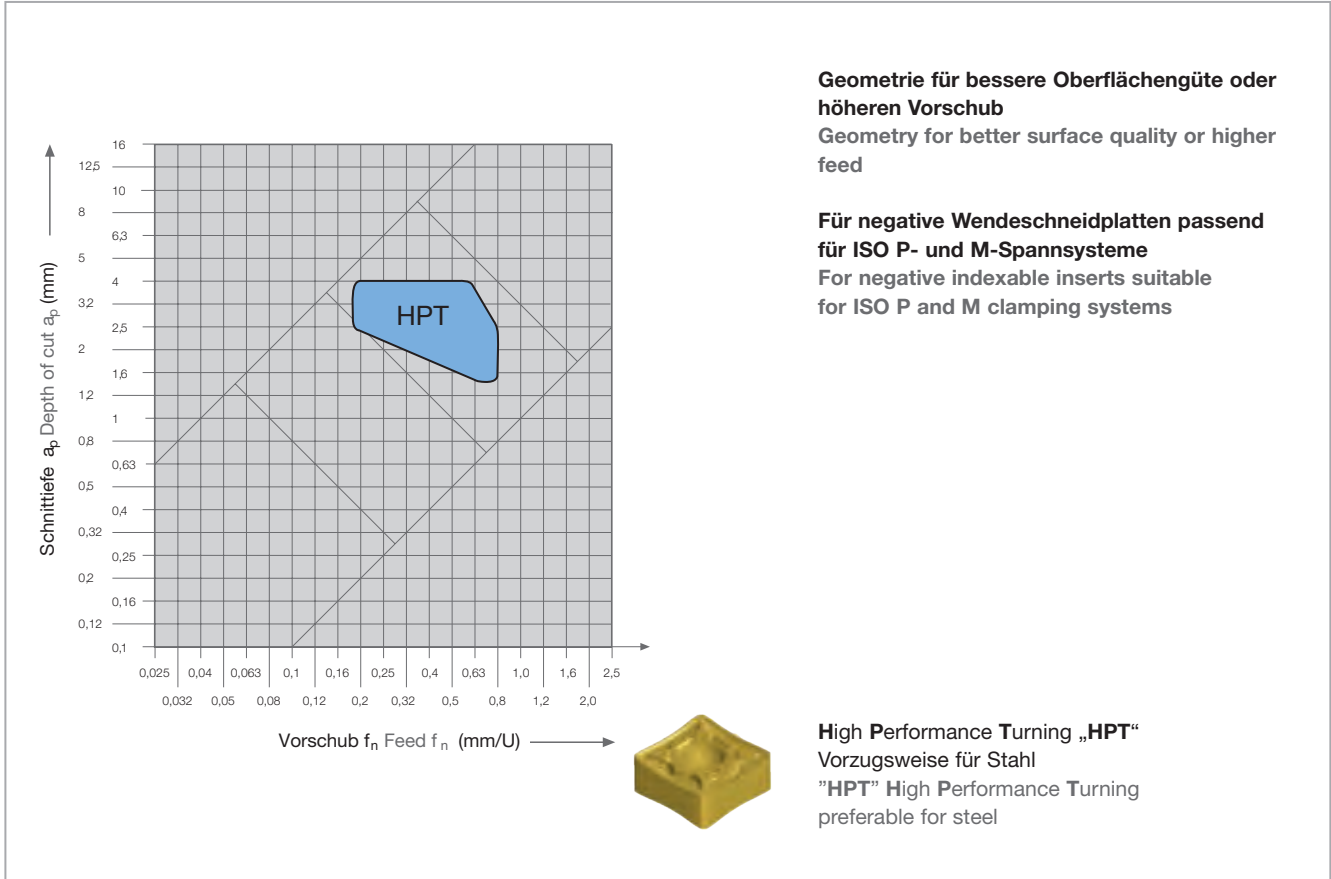

Ra - Werte / Ra - Values CNMG 120408 ISO / HPT / Wiper

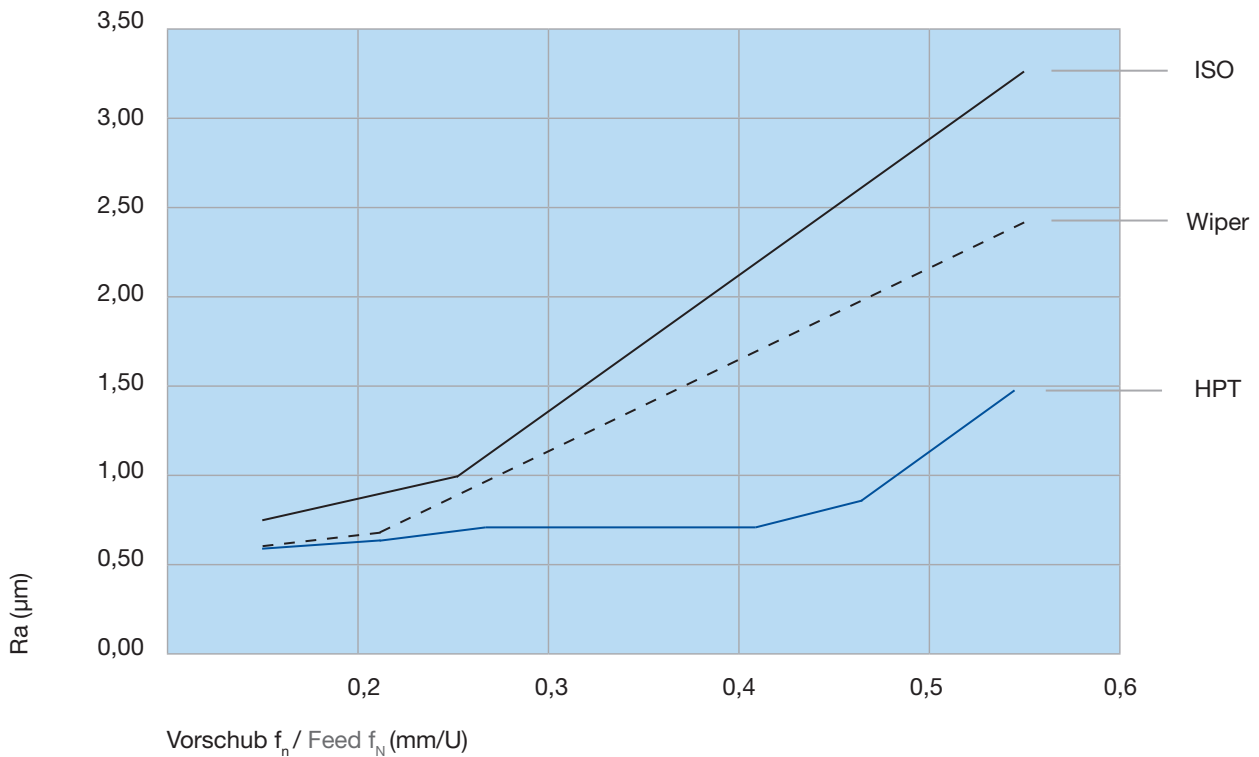

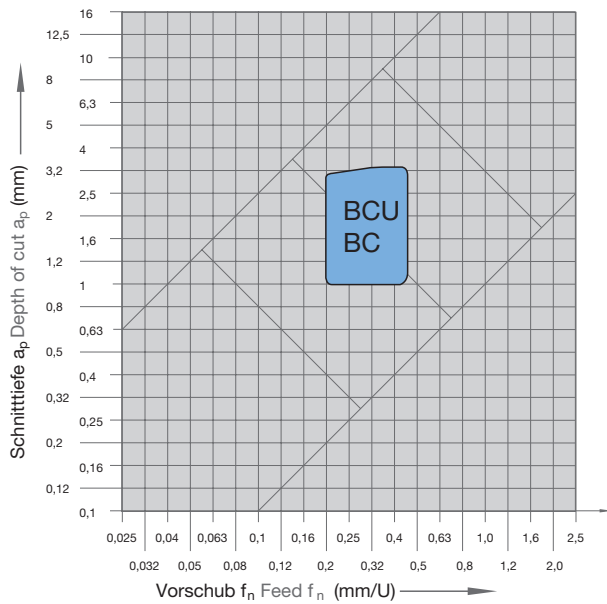

Geometrie zum Kopierdrehen
Geometry for copy turning

Für negative Wendeschneidplatten passend
für das ISO P- und M-Spannsystem
For negative indexable inserts suitable
for ISO P- and M-clamping system

Nur für Innenbearbeitung!
Only for internal machining!

***) Achtung: Bei Verwendung von BC - Geometrieplatte**
linke Platten für rechte Halter und rechte Platten für
linken Halter verwenden!

***) Attention: When working with BC - Geometry inserts,**
please use lefthand inserts with righthand holders
and righthand inserts with lefthand holders.



Geometrie zum Drehen „BCU“
(Boehlerit Copy Universal)
Geometry for turning “BCU”
(Boehlerit Copy Universal)

Geometrie zum Kopierdrehen „BC“
(Boehlerit Copying *)
Geometry “BC” (Boehlerit Copying *)

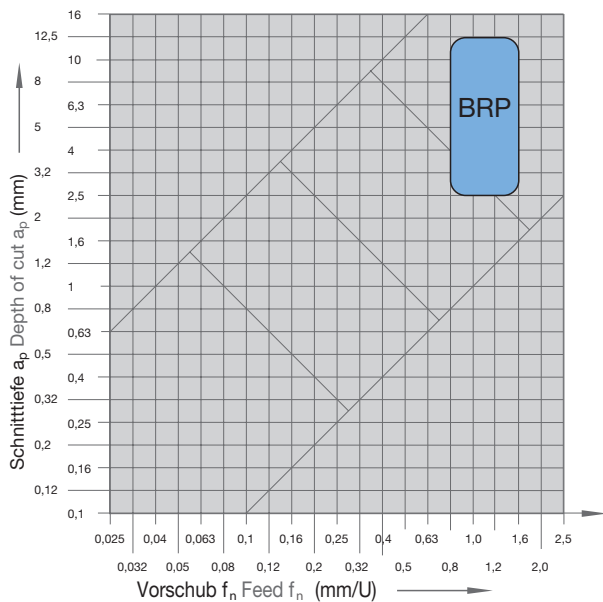

Schruppgeometrien
Roughing geometries

Für negative Wendeschneidplatten passend
für ISO P- und M-Spannsysteme
For negative indexable inserts suitable
for ISO P- and M-clamping systems

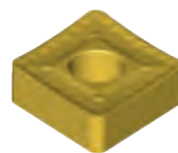

Schruppgeometrie „BRP“
(Boehlerit Roughing ISO-P)
“BRP” Roughing
(Boehlerit Roughing ISO-P)

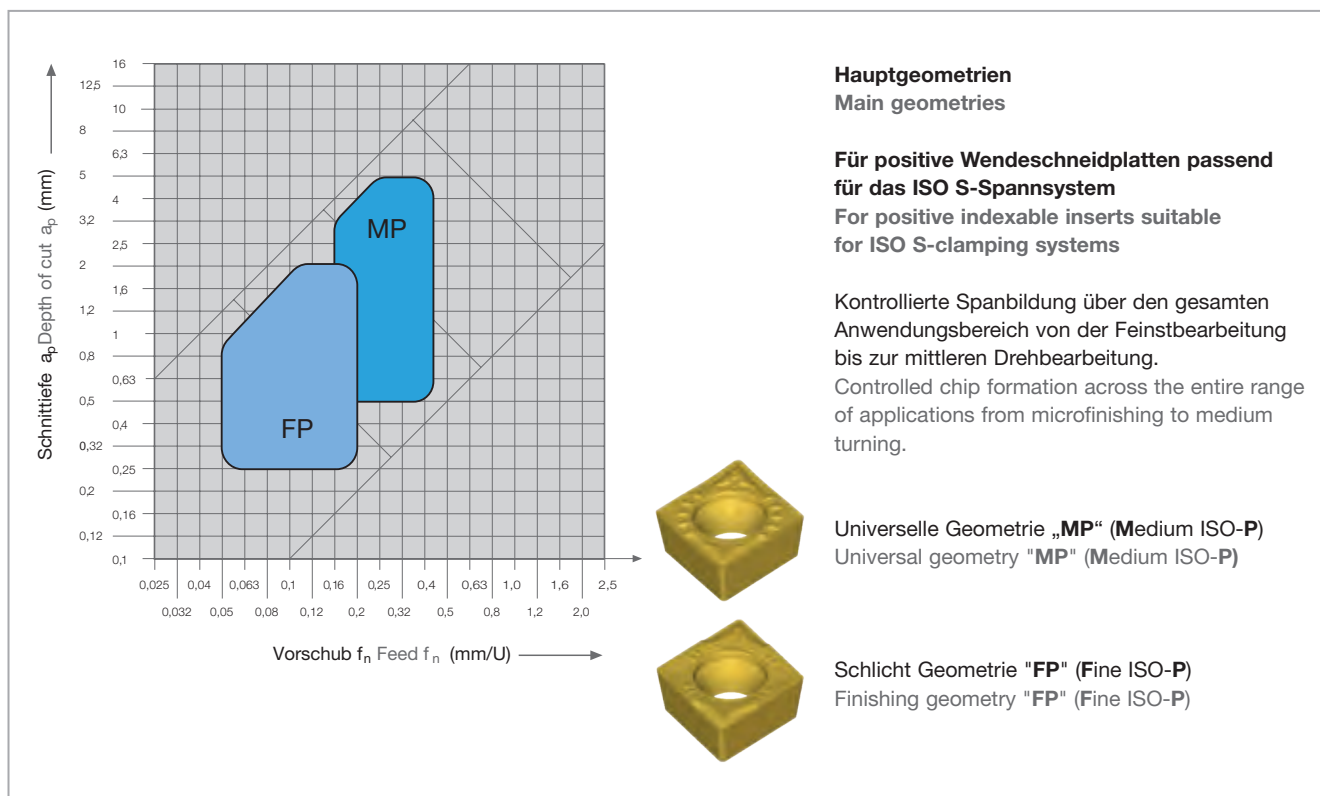
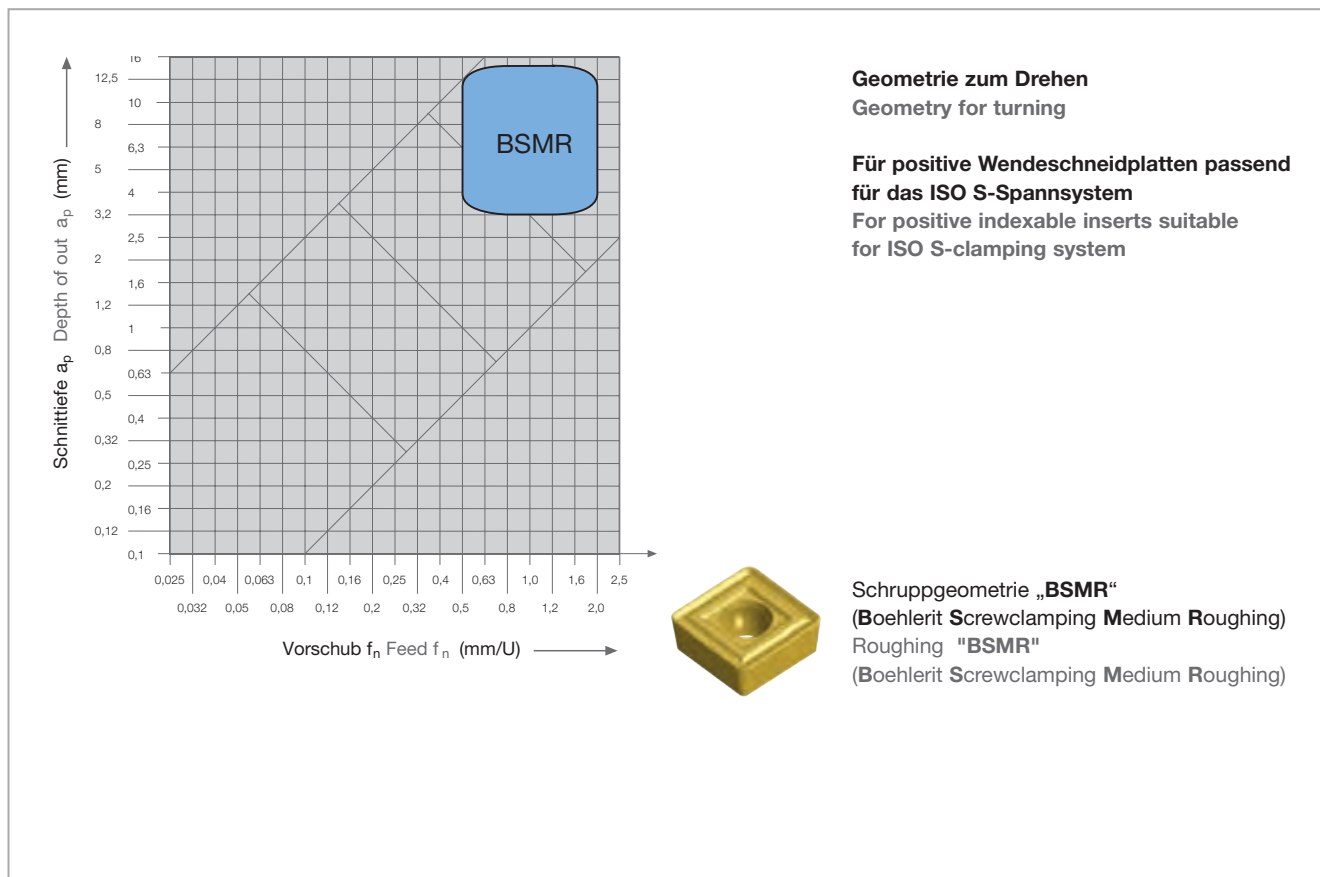

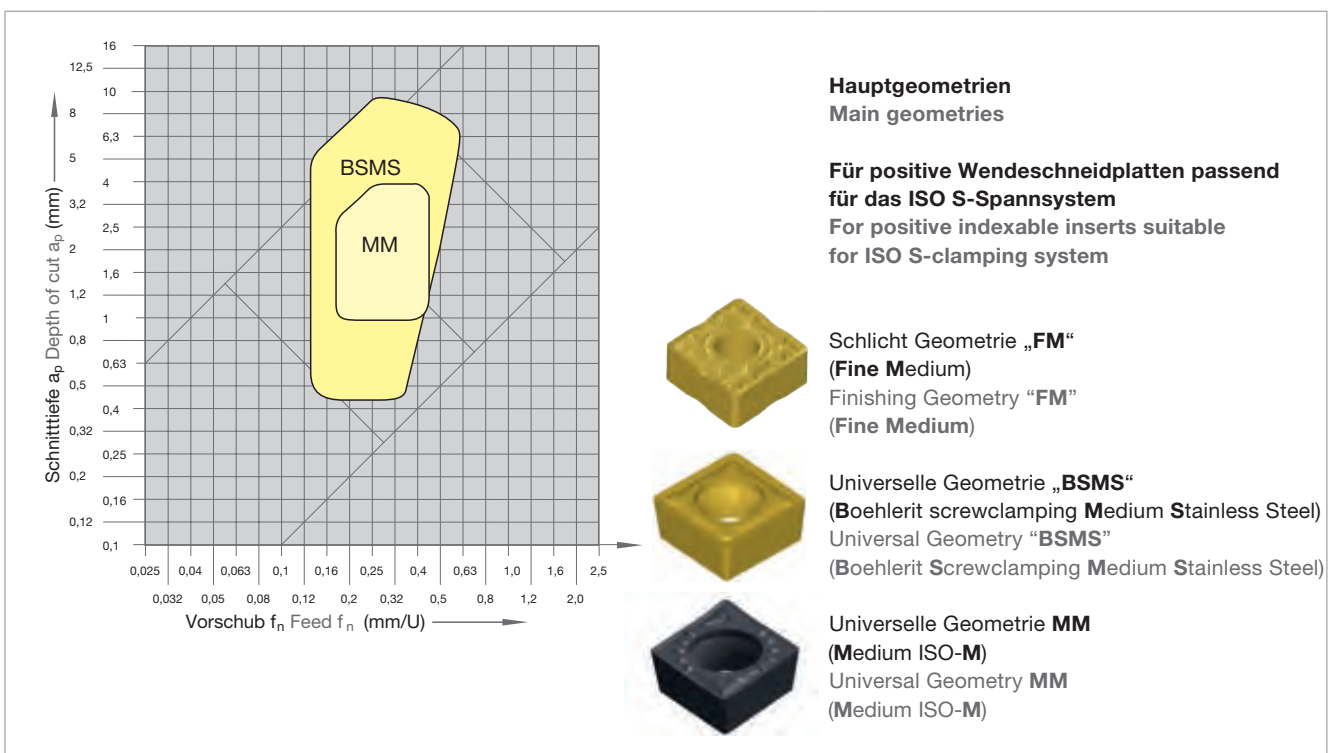
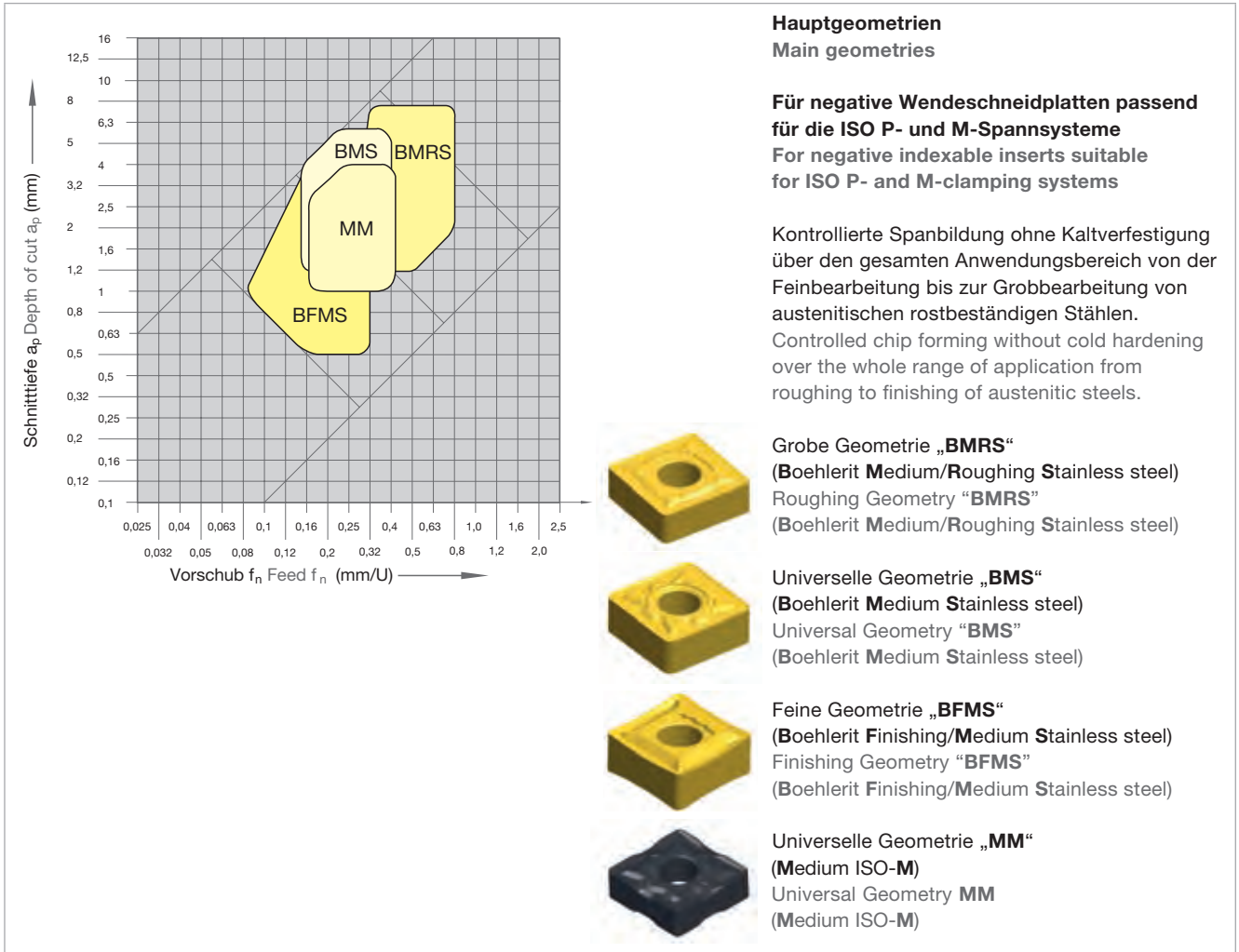

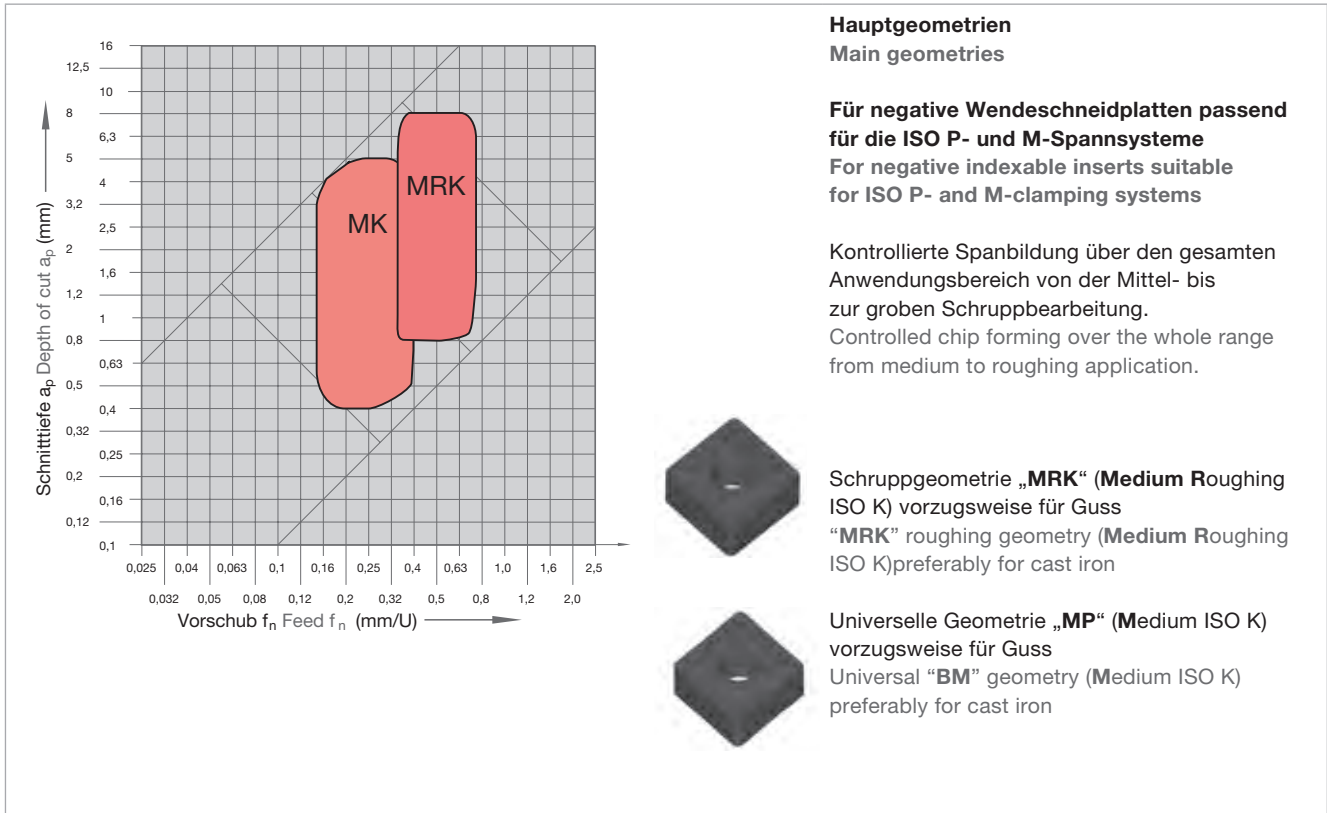

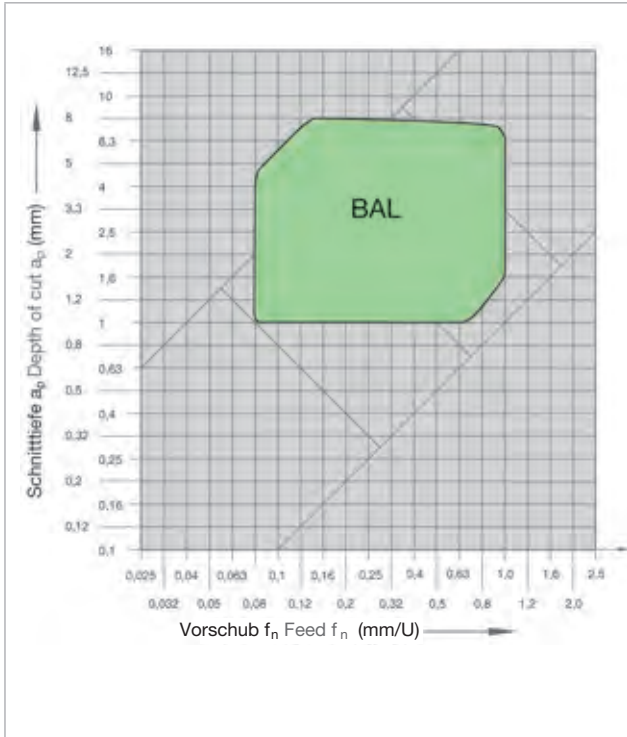

Hauptgeometrie für Aluminium
Geometry for aluminium machining

Für positive Wendschneidplatten passend für das ISO S-Spannsystem
For positive indexable inserts suitable for ISO S-clamping system

Auch hervorragend zum Schlichten von rostfreien Stählen geeignet.
Best suitable for finishing of stainless steels also.



Geometrie für Aluminium „BAL“
(Boehlerit-ALuminium)
Geometry “BAL”
(Boehlerit ALuminium)

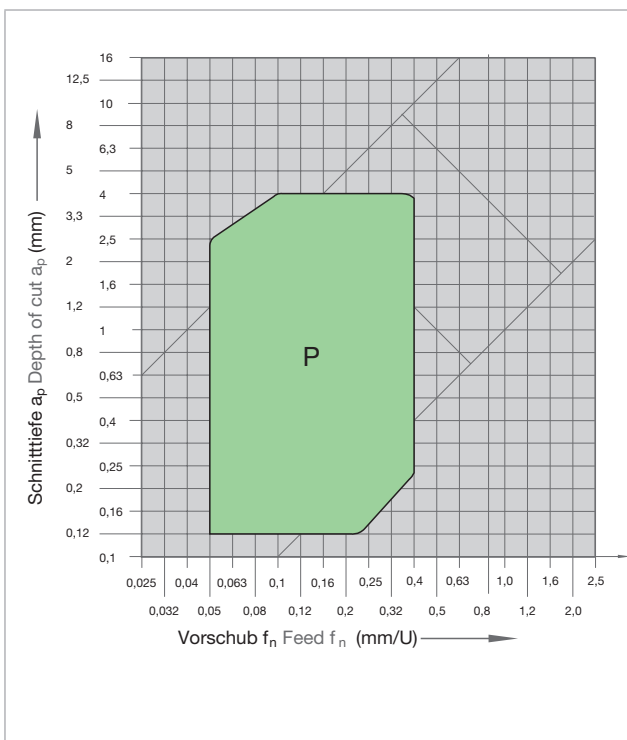

Hauptgeometrie für Kunststoff
Geometry for plastic machining

Für positive Wendschneidplatten passend für das ISO S-Spannsystem
For positive indexable inserts suitable for ISO S-clamping system



Geometrie für Kunststoff „P“
(Boehlerit-Plastik)
Geometry “P”
(Boehlerit Plastics)

Spanformstufengeometrien für Superlegierungen Chip groove geometries for super alloys

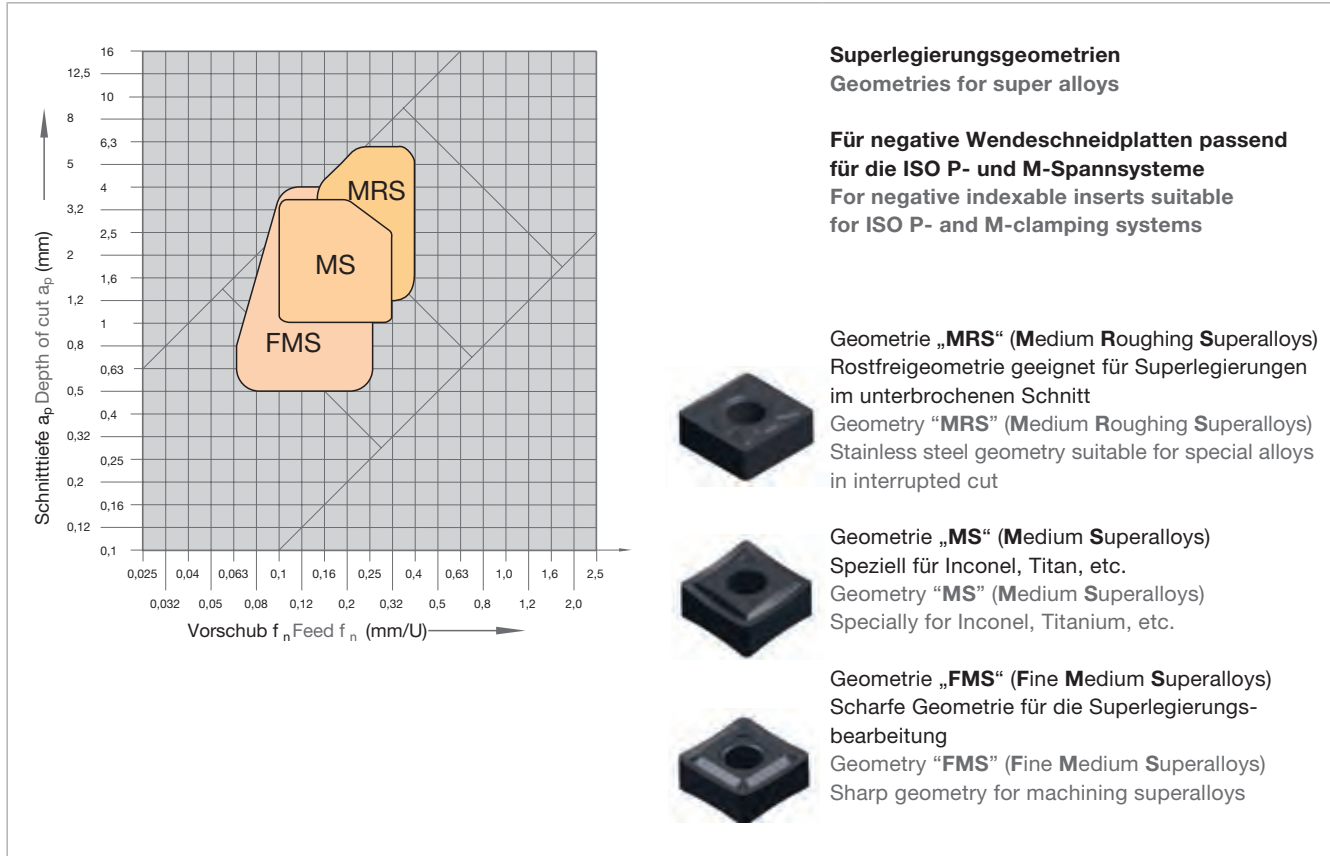

Spanformstufengeometrien für Titan und Superlegierungen Chip groove geometries for titanium and super alloys

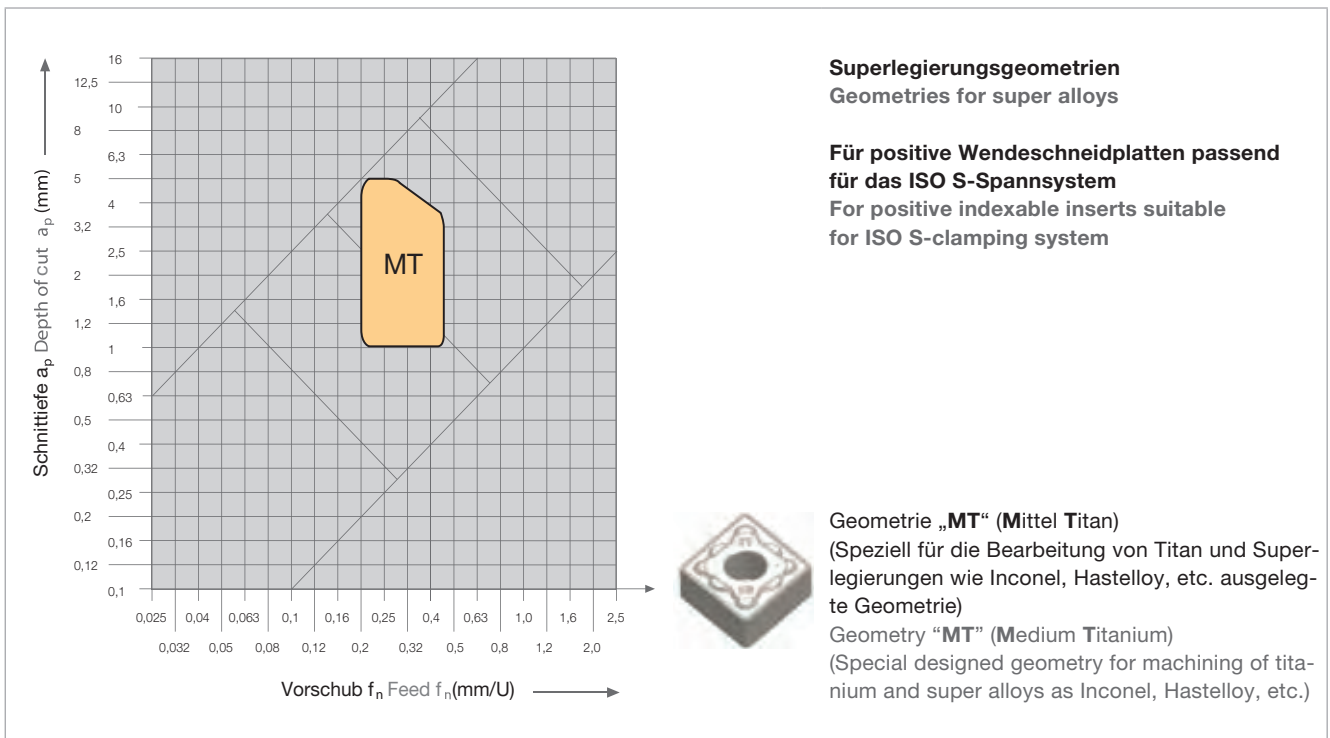

Schnitttiefen der Spanformstufengeometrien
Depth of cut for chipbreaker



	a_p mm	0,5	1	1,5	2	2,5	3	3,5	4	4,5	5	5,5	6	6,5	7	7,5	8	8,5	9	9,5	10	11	12				
Schlichten f (mm/U) Finishing f (mm/rev)	0,05–0,2			FP FM																							
	0,1–0,3					FMP																					
	0,1–0,3					FMS																					
	0,1–0,3					BFMS																					
Mittlere Bearbeitung f (mm/U) Medium machining f (mm/rev)	0,2–0,4					MS																					
	0,15–0,4					MM																					
	0,16–0,4					MP MK																					
	0,16–0,4					BMS																					
	0,2–0,45					MT																					
	0,2–0,5					MRS																					
	0,15–0,4					BM																					
	0,2–0,6					HPT																					
	0,2–0,5					BSMS																					
	0,15–0,65					BAL																					
	0,1–1,0					P																					
Schruppen f (mm/U) Roughing f (mm/rev)	0,2–0,45					BC BCU																					
	0,35–0,6					BMRS																					
	0,5–2,0	BSMR																									
	0,32–0,8											MRP MRK BMR															
0,4–1,6	RP BR, BRP																										

Sortenübersicht
Grade overview



Sorte Grade	ISO	Anwendungsbereich Application range	Werkstoffgruppe Material group						Bearbeitungsverfahren Application					
			P	M	K	N	S	H	T	M	D	S	G	P
			Stahl Steel	Rostfrei Stainless	Grauguss Grey cast iron	NE-Metalle Non-ferrous metals	Hochwärmfest High tempera- ture materials	Harte Werkstoffe Hard materials	Drehen Turning	Fräsen Milling	Bohren Drilling	Gewinde- bearbeitung Threading	Einstechen Grooving	Abstechen Parting
LCP15T	HC-P15		■							●				
	HC-K15				■					●				
LCP25T	HC-P25		■							●				
	HC-M25			■						●				
LC240F	HC-P40		■							●				
	HC-M40			■						●				
LCM20T	HC-M20			■						●				
	HC-S20							■		●				
BCM25T	HC-M25			■						●				
	HC-P30		■							●				
BCM40T	HC-M40			■						●				
	HC-S40							■		●				
LC435D	HC-M35			■						●				
	HC-P35		■							●				
LCM45T	HC-M40			■						●	●			
	HC-P35		■							●	●			
BCK10T	HC-K10				■					●				
	HC-K15				■					●				
BCK20T	HC-K20				■					●				
LW610	HW-K10					■				●	●			
LC610T	HC-K10		■	■	■	■				●				
LC415X	HC-S15			■				■		●				
LC415Z	HC-S15			■				■		●				
BCS10T	HC-M10							■		●				
	HC-S10			■						●				
BCS20T	HC-M20							■		●				
	HC-S20			■						●				
LW611	HW-K10				■	■				●				

Anwendungsschwerpunkt
Application peak



Gesamtbereich nach ISO 513
Full range to ISO 513

- Hauptanwendung
Main application
- Weitere Anwendungen
Further applications

- Standardsorte
Standard grade

Schneidstoffsorten

Hauptsorten beschichtet

- **LCP15T (HC-P15, HC-K15)**

Verschleißfeste Stahlsorte für den nichtunterbrochenen Schnitt für hohe Schnittgeschwindigkeiten bis 300 m/min. Als Nebenanwendung auch für die Bearbeitung von Guss geeignet.

- **LCP25T (HC-P25, HC-M25)**

(Universelle Drehsorte)
Hauptsorte zum Drehen von Stahlwerkstoffen und leicht zerspanbaren rostbeständigen Stahl bei mittleren Schnittgeschwindigkeiten, auch bei unterbrochenem Schnitt. Diese Mehrbereichssorte zeichnet sich durch hohe Verschleißfestigkeit und ausgezeichnete Zähigkeitseigenschaften in einem breiten Einsatzspektrum aus.

- **LC240F (HC-P40, HC-M40)**

Die Stahldrehsorte Steeltec LC240F gewährleistet durch das Zusammenspiel eines extrem zähen Hartmetalls mit der „Nanlock gelb MT-CVD-Schicht“ höchste Performance im stark unterbrochenen Schnitt.

- **LCM20T (HC-M20, HC-S20)**

Drehsorte für die Bearbeitung von austenitischen Werkstoffen im hohen Schnittgeschwindigkeitsbereich von 170 - 220 m/min.

- **BCM25T (HC-M25, HC-P25)**

Drehsorte für austenitische rostfreie Stähle im mittleren bis hohen Schnittgeschwindigkeitsbereich.

- **BCM40T (HC-M40, HC-S40)**

Sehr zähe Rostfreisorte für niedrige Schnittgeschwindigkeiten geeignet, als Alternative auch auf Stahl und Superlegierungen einsetzbar.

- **LC435D (HC-M35, HC-P35)**

Hauptsorte zu Drehen von austenitischen rostfreien Stählen bei mittleren Schnittgeschwindigkeiten. Erweiterte Anwendung für Superlegierungen.

- **LCM45T (HC-M40, HC-P40)**

Extrem zähes, relativ feinkörniges Hartmetallsubstrat. Ideale Sorte zum Drehen von austenitischen rostfreien Stählen im mittleren Schnittgeschwindigkeitsbereich.

- **BCK10T (HC-K10-K15)**

Gusssorte im Bereich K10, optimal für die Bearbeitung von Guss im nicht unterbrochenen Schnitt.

- **BCK20T (HC-K20)**

Gussdrehsorte im Bereich K20, optimal für die Bearbeitung von GG- und GGG- Materialien. Schnittgeschwindigkeiten bis 400m/min auf GG möglich.

- **LC610T (HC-K10)**

Ideale Sorte für die Bearbeitung von Aluminiumwerkstoffen und NE-Metallen. Durch eine hauchdünne Micropuls® Plasma-CVD TiAlN Schicht ebenfalls hervorragend für die Schlichtzerspannung von rostfreien Stählen und Grauguss geeignet.

- **BCS10T (HC-M10, HC-S10)**

Sorte für das Drehen von Titan. Ausgewähltes temperaturstabiles Hartmetall plus TiBN - Plasma - Beschichtung.

- **LC415X (HC-S15)**

Feinstkornsorte mit dünner PVD-Beschichtung. Hervorragend geeignet für die Klein- und Kleinstteillfertigung wie z.B. der Uhrenindustrie und Medizintechnik. Bevorzugte Materialien wie Inconel, Titan und Rostfreistahl.

- **LC415Z (HC-S15)**

Spezielle Feinstkornsorte für die Bearbeitung von Superlegierungen wie Inconel, Titan, etc.

- **BCS20T (HC-M20, HC-S20)**

Zähere Alternativsorte zur LC415Z für die Bearbeitung von Superlegierungen wie Inconel, Hastelloy, Waspaloy, etc.

Hauptsorten unbeschichtet

- **LW610 (HW-K10)**

Drehsorte mit hoher Verschleißfestigkeit für die Bearbeitung von Aluminiumlegierungen und NE-Metallen bei mittleren bis hohen Schnittgeschwindigkeiten, auch unter ungünstigen Bedingungen.

- **LW611 (HW-K05, HW-K15)**

Zum Drehen von Hartguss, Grauguss mit Kugelgraphit und legiertem Grauguss sowie für Aluminium und Aluminiumlegierungen. Drehen von hochvergüteten und gehärteten Stählen, auch für Manganhartstähle.

Cutting grades

Main grades, coated

- **LCP15T (HC-P15, HC-K15)**

Wear resistant steel grade for not interrupted cut for high cutting speeds up to 300 m/min. As secondary application also for machining of cast iron.

- **LCP25T (HC-P25, HC-M25)**

(Universal turning grade)

Main grade for machining steel materials and easily machinable stainless steels at medium cutting speeds, including interrupted cutting work. This general purpose grade is characterised by the properties of high durability and excellent toughness across a wide range of applications.

- **LC240F (HC-P40, HC-M40)**

The LC240F Steeltec steel turning grade guarantees maximum performance in heavy interrupted cutting thanks to the combination of an extremely tough carbide with the „Nanolock yellow MT-CVD layer“.

- **LCM20T (HC-M20, HC-S20)**

Turning grade for machining of austenitic materials in the high cutting speed area of 170 – 220 m/min.

- **BCM25T (HC-M25, HC-P25)**

Turning grade for austenitic stainless steels in medium and high cutting speed area.

- **BCM40T (HC-M40, HC-S40)**

Very tough stainless grade for low cutting speeds suitable, also as alternative applicable on steel and super alloys.

- **LC435D (HC-M35, HC-P35)**

Main grade for turning of austenitic stainless steels at medium cutting speeds. Applicable also for super alloys.

- **LCM45T (HC-M40, HC-P40)**

Extreme tough, relative fine grained carbide substrate. Ideal grade for turning of austenitic stainless steel in the medium cutting speed area.

- **BCK10T (HC-K10-K15)**

Cast iron grades in K10 range, optimum for machining cast iron in an uninterrupted cut.

- **BCK20T (HC-K20)**

Cast iron turning grade for the area K15. Optimal for machining GG- and GGG- materials. Possible cutting speeds for GG up to 400 m/min.

- **LC610T (HC-K10)**

The ideal grade for working aluminium materials and other non-ferrous metals. Thanks to a very thin microplus® plasma CVD TiAlN coating it is also excellent for finish machining of stainless steels and grey cast iron.

- **BCS10T (HC-M10, HC-S10)**

Grade for turning of titanium. Selected temperature stable carbide plus TiBN - Plasma coating.

- **LC415X (HC-S15)**

Submicron grade with thin PVD-coating. Excellent appropriate for the production of small and smallest parts, f.e. watch industry and medical engineering. Preferred materials such as Inconel, titanium and stainless steel.

- **LC415Z (HC-S15)**

Special submicron grade for machining super alloys such as Inconel, titanium, etc.

- **BCS20T (HC-M20, HC-S20)**

Tough alternative grade to LC415Z for machining of super alloys as Inconel, Hastelloy, Waspaloy, etc.

Main grades, uncoated

- **LW610 (HW-K10)**

Turning grade with high wear resistance for machining of aluminium alloys, and non-ferrous metals at medium to higher cutting speeds, even under unfavourable machining conditions.

- **LW611 (HW-K05, HW-K15)**

For turning chilled iron casting, grey cast iron with spheroidal graphite and alloyed grey cast iron as well as for aluminium and aluminium alloys. Turning high grade and hardened steels, also for austenitic manganese steels.

W	
Grundform	Basic form
A	85°
B	82°
C	80°
D	55°
E	75°
H	120°
K	55°
L	90°
M	86°
O	135°
P	108°
R	-
S	90°
T	60°
V	35°
W	80°

N	
Freiwinkel	Clearance angle
A	3°
B	5°
C	7°
D	15°
E	20°
F	25°
G	30°
N	0°
P	11°
O	α°

Freiwinkel, bei denen besondere Angaben erforderlich sind
Clearance angle requiring special indication

M			
Toleranzklasse			
Tolerance classes			
Zulässige Abweichung für Limits of tolerance			
	m	s	d
A	±0,005 ¹⁾	±0,025	±0,025
C	±0,013	±0,025	±0,025
E	±0,025	±0,025	±0,025
F	±0,005 ¹⁾	±0,025	±0,013
G	±0,025	±0,13	±0,025
H	±0,013	±0,025	±0,013
J	±0,005 ¹⁾	±0,025	±0,05 – ±0,15
K	±0,013 ¹⁾	±0,025	±0,05 – ±0,15
L	±0,025	±0,025	±0,05 – ±0,15
M	±0,08 – ±0,20	±0,13	±0,05 – ±0,15
U	±0,13 – ±0,38	±0,13	±0,08 – ±0,25
	d	m	d
M	6,35	±0,08	±0,05
	9,52	±0,08	±0,05
	12,7	±0,13	±0,08
	15,88	±0,15	±0,10
	19,05	±0,15	±0,10
	25,4	±0,18	±0,13
U	6,35	±0,13	±0,08
	9,52	±0,13	±0,08
	12,7	±0,20	±0,13
	15,88	±0,27	±0,18
	19,05	±0,27	±0,18
	25,4	±0,38	±0,25

Wendeschneidplatte mit ungerader Seitenanzahl
Indexable insert with unequal number of sides

Wendeschneidplatte mit gerader Seitenanzahl
Indexable insert with equal number of sides

¹⁾ Gelten in der Regel für Wendeschneidplatten mit geschliffenen Planschneiden.
^{*)} Der Berechnung der „m“-Maße liegt der genaue Zoll-Radius zugrunde.

¹⁾ Generally used for indexable inserts with ground face cutting edges.
^{*)} The calculation for the “m” measurement is based on the precise radius in inches.

G	
Plattentyp	Type of insert
A	ohne Spanformrinne, mit Befestigungsloch without chip breaker, with cylindrical fixation hole
F	mit Spanformrinne auf beiden Spanflächen, ohne Befestigungsloch Chip breaker at both sides, without fixation hole
G	mit Spanformrinne auf beiden Spanflächen, mit Befestigungsloch Chip breaker at both sides, with cylindrical fixation hole
M	mit Spanformrinne auf einer Spanfläche, mit Befestigungsloch Chip breaker at one side, with cylindrical fixation hole
N	ohne Spanformrinne, ohne Befestigungsloch without chip breaker, without fixation hole
Q	ohne Spanformrinne, mit Kegelloch beidseitig without chip breaker, with fixation hole conical from both sides
R	mit Spanformrinne auf einer Spanfläche, ohne Befestigungsloch Chip breaker at one side, without fixation hole
T	mit Spanformrinne auf einer Spanfläche, Kegelloch einseitig Chip breaker at one side, with conical fixation hole
U	mit Spanformrinne auf beiden Spanflächen, Kegelloch beidseitig Chip breaker at both sides, with fixation hole conical from both sides
W	ohne Spanformrinne, Kegelloch einseitig without chip breaker, with conical fixation hole
X	mit Besonderheiten nach Zeichnung with special features to drawing











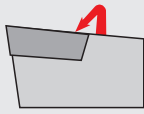

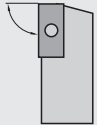
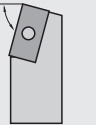

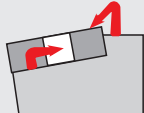

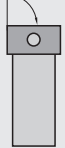



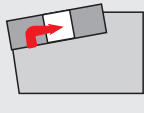

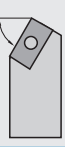
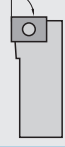

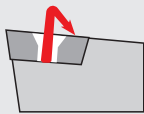

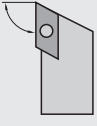
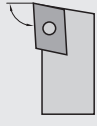



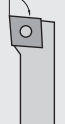
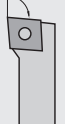



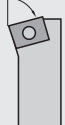
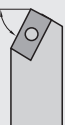





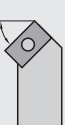

06 Schneidkantenlänge Length of cutting edge	
A	
B	
C	
E	
D	
H	
K	
L	
M	
O	
P	
R	
S	
T	
V	
W	
Beispiele: Examples:	
06	l = 6,350 mm
09	l = 9,525 mm
11	l = 11,000 mm
12	l = 12,700 mm
15	l = 15,880 mm
16	l = 16,500 mm
19	l = 19,050 mm
22	l = 22,000 mm
25	l = 25,400 mm
27	l = 27,500 mm
33	l = 33,000 mm

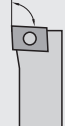
04 Dicke Thickness	
Beispiele: Examples:	
01	s = 1,59 mm
T1	s = 1,98 mm
02	s = 2,38 mm
03	s = 3,18 mm
T3	s = 3,97 mm
04	s = 4,76 mm
05	s = 5,56 mm
06	s = 6,35 mm
07	s = 7,94 mm
09	s = 9,52 mm
12	s = 12,70 mm

04 Schneidenecke Corner radius	
Beispiele: Examples:	
00	r = max 0,2 mm
04	r = 0,4 mm ±0,1
08	r = 0,8 mm ±0,1
12	r = 1,2 mm ±0,1
16	r = 1,6 mm ±0,1
20	r = 2,0 mm ±0,1
24	r = 2,4 mm ±0,1
25	r = 2,5 mm ±0,1

Schneidenausführung Edge condition	
F	
scharfe Schneide sharp cutting edges	
E	
Schneiden gerundet Rounded cutting edges	
S	
Schneiden gefast und gerundet Chamfered and rounded cutting edges	
T	
Schneiden gefast Chamfered cutting edges	
K	
Schneiden doppelt gefast Double-chamfered cutting edges	
P	
Schneiden doppelt gefast und verrundet Double-chamfered and rounded cutting edges	

Schnitttrichtung Cutting direction	
L	
Wendeschneidplatte kann nur linksschneidend verwendet werden The indexable insert can only be used for cuts to the left	
N	
Wendeschneidplatte kann rechts- und linksschneidend verwendet werden The indexable insert can be used for cuts either to the left or to the right	
R	
Wendeschneidplatte kann nur rechtsschneidend verwendet werden The indexable insert can only be used for cuts to the right	

P Befestigungsart Type of fixation	C Wendeplattenform Indexable insert shape	L Klemmhalterform Tool holder shape	N Wendeplattenfreiwinkel Insert clearance angle
C  Von oben geklemmt Fixation from above	A  85° B  82°	A  90° B  75°	A  3°
M  Von oben und über Bohrung geklemmt Fixation from above and through a hole	C D  80° E  55°	C  90° D  45°	B  5° C  7°
P  Über Bohrung geklemmt Fixation through a hole	H  120° K  55°	E  60° F  90°	D  15° E  20°
S  Durch Bohrung geschraubt Fixation by screw through a conical hole	L  90° M  86°	G  90° J  93°	F  25° G  30°
	O  135° P  108°	H  107,5° L  95°	E  20° F  25°
	R  - S  90°	K  75° N  63°	F  25° G  30°
	T  60° V  35°	M  50° S  45°	G  30° N  0°
	W  80°	R  75° U  93°	P  11° O  3°
		T  60° W  60°	O  3°
		V  72,5° Y  85°	O  3° Freiwinkel, bei denen besondere Angaben erforderlich sind Clearance angle requiring special indication

R
Schnittrichtung
Cutting direction

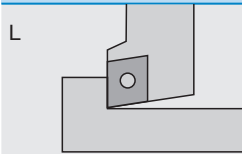

Klemmhalter kann nur linksschneidend verwendet werden
The tool holder can only be used for cuts to the left

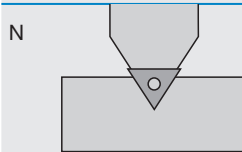

Klemmhalter kann rechts- und linksschneidend verwendet werden
The tool holder can be used for cuts either to the left or to the right

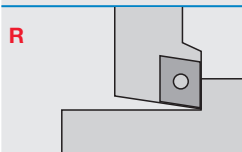

Klemmhalter kann nur rechtsschneidend verwendet werden
The tool holder can only be used for cuts to the right

25
Schneidenhöhe
Cutting height

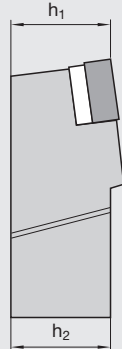

Bei Klemmwerkzeugen entspricht die Schneidenhöhe (h_1) im allgemeinen der Schafthöhe (h_2). Ausgenommen sind Kurzklemmhalter und Klemmwerkzeuge zum Innendrehen.

For clamped tools, the cutting height (h_1) generally corresponds to the shaft height (h_2). The exceptions to this include cartridge toolholders and clamped tools for internal turning.

25
Schaftbreite
Shank width



M
Werkzeuglänge
Tool length

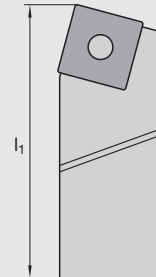

Kennbuchstaben für die Längen l_1
Code letters for the length l_1

A	32 mm
B	40 mm
C	50 mm
D	60 mm
E	70 mm
F	80 mm
G	90 mm
H	100 mm
J	110 mm
K	125 mm
L	140 mm
M	150 mm
N	160 mm
P	170 mm
Q	180 mm
R	200 mm
S	250 mm
T	300 mm
U	350 mm
V	400 mm
W	450 mm
X	Sonderlänge Special length
Y	500 mm

12
Schneidkantenlänge
Cutting edge length

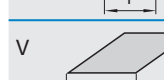
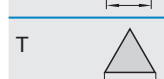
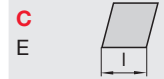
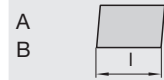

Beispiele:
Examples:

06	$l = 6,350 \text{ mm}$
09	$l = 9,525 \text{ mm}$
11	$l = 11,000 \text{ mm}$
12	$l = 12,700 \text{ mm}$
15	$l = 15,880 \text{ mm}$
16	$l = 16,500 \text{ mm}$
19	$l = 19,050 \text{ mm}$
22	$l = 22,000 \text{ mm}$
25	$l = 25,400 \text{ mm}$
27	$l = 27,500 \text{ mm}$
33	$l = 33,000 \text{ mm}$

S Werkstoff des Körpers Material used for main body		
Kennbuchstabe Identification letter	Werkstoff des Körpers Material used for main body	Konstruktionsmerkmale Features of design
S	Stahlschaft Solid steel	keine none
A		mit innerer Kühlmittelzuführung with internal coolant supply
B		mit Vibrationsdämpfung with vibration damping
D		mit Vibrationsdämpfung und innerer Kühlmittelzuführung with vibration damping and internal coolant supply
C	Hartmetallschaft mit Stahlkopf Hard metal with steel head	keine none
E		mit innerer Kühlmittelzuführung with internal coolant supply
F		mit Vibrationsdämpfung with vibration damping
G		mit Vibrationsdämpfung und innerer Kühlmittelzuführung with vibration damping and internal coolant supply
H		Schwermetall Heavy metal
J	mit innerer Kühlmittelzuführung with internal coolant supply	

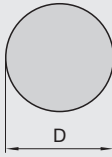
32 Schaftdurchmesser Shank diameter

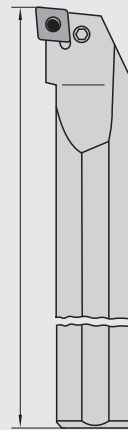
08 10 12 16 20 25 32 40 50

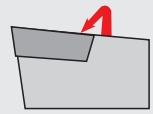
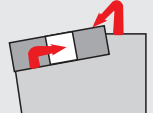
T Werkzeuglänge Tool length

P Befestigungsart Type of fixation
C  Von oben geklemmt Fixation from above
M  Von oben und über Bohrung geklemmt Fixation from above and through a hole

Kennbuchstaben für die Längen
Code letters for the length

A	32 mm
B	40 mm
C	50 mm
D	60 mm
E	70 mm
F	80 mm
G	90 mm
H	100 mm
J	110 mm
K	125 mm
L	140 mm
M	150 mm
N	160 mm
P	170 mm
Q	180 mm
R	200 mm
S	250 mm
T	300 mm
U	350 mm
V	400 mm
W	450 mm
X	Sonderlänge Special length
Y	500 mm

P  Über Bohrung geklemmt Fixation through a hole

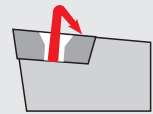
S  Durch Bohrung geschraubt Fixation by screw through a conical hole

C Wendepplattenform Indexable insert shape		
A		85°
B		82°
C		80°
D		55°
E		75°
H		120°
K		55°
L		90°
M		86°
O		135°
P		108°
R		-
S		90°
T		60°
V		35°
W		80°

L Klemhalterform Tool holder shape		
F		90°
K		75°
L		95°
S		45°
U		93°
Q		107°

N Wendepplattenfreiwinkel Insert clearance angle		
A		3°
B		5°
C		7°
D		15°
E		20°
F		25°
G		30°
N		0°
P		11°
O		α°

Freiwinkel, bei denen besondere Angaben erforderlich sind.
Clearance angle requiring special indication.

R Schnitttrichtung Cutting direction	
L	
<p>Halter kann nur linksschneidend verwendet werden Boring bar suitable for operation to the left only</p>	
R	
<p>Halter kann nur rechtsschneidend verwendet werden Boring bar suitable for operation to the right only</p>	

12 Schneidkantenlänge Cutting edge length	
A	
B	
C	
E	
D	
H	
K	
L	
M	
O	
P	
R	
S	
T	
V	
W	

Beispiele:
Examples:

- 06 l = 6,350 mm
- 09 l = 9,525 mm
- 11 l = 11,000 mm
- 12 l = 12,700 mm**
- 15 l = 15,880 mm
- 16 l = 16,500 mm
- 19 l = 19,050 mm
- 22 l = 22,000 mm
- 25 l = 25,400 mm
- 27 l = 27,500 mm
- 33 l = 33,000 mm

	Bestellbezeichnung Ordering code	l	d	s	r	Sorte Grade																			
						HC						HW		HC		HW									
						LCP15T	LCP25T	LC240F	LCM20T	LC435D	BCM25T	BCM40T	BCK10T	BCK20T	LW611	LC610T	LW610	LC415X	LC415Z	BCS10T	BCS20T				
CCGT...BAL 	CCGT 060202-BAL	6,40	6,35	2,38	0,2																				
	CCGT 060204-BAL	6,40	6,35	2,38	0,4																				
	CCGT 09T302-BAL	9,70	9,52	3,97	0,2																				
	CCGT 09T304-BAL	9,70	9,52	3,97	0,4																				
	CCGT 09T308-BAL	9,70	9,52	3,97	0,8																				
	CCGT 120404-BAL	12,90	12,70	4,76	0,4																				
	CCGT 120408-BAL	12,90	12,70	4,76	0,8																				
CCGT E.-BC 	CCGT 060204 EL-BC	6,40	6,35	2,38	0,4		●	●		●															
	CCGT 060204 ER-BC	6,40	6,35	2,38	0,4		●			●															
	CCGT 060208 EL-BC	6,40	6,35	2,38	0,8		●	●		●															
	CCGT 060208 ER-BC	6,40	6,35	2,38	0,8		●			●															
	CCGT 09T304 EL-BC	9,70	9,52	3,97	0,4		●	●		●															
	CCGT 09T304 ER-BC	9,70	9,52	3,97	0,4		●	●		●															
	CCGT 09T308 EL-BC	9,70	9,52	3,97	0,8		●			●															
	CCGT 09T308 ER-BC	9,70	9,52	3,97	0,8		●	●		●															
	CCGT 120408 EL-BC	12,90	12,70	4,76	0,8		●	●		●															
	CCGT 120408 ER-BC	12,90	12,70	4,76	0,8		●	●		●															
	CCGT 120412 EL-BC	12,90	12,70	4,76	1,2		●	●		●															
CCGT 120412 ER-BC	12,90	12,70	4,76	1,2		●			●																
CCMT....BSMR 	CCMT 250924-BSMR	25,80	25,40	9,52	2,4	●	●																		
CCMT....BSMS 	CCMT 09T304-BSMS	9,70	9,52	3,97	0,4					●															
	CCMT 09T308-BSMS	9,70	9,52	3,97	0,8					●															
	CCMT 120404-BSMS	12,90	12,70	4,76	0,4					●															
	CCMT 120408-BSMS	12,90	12,70	4,76	0,8					●															
CCMT....F. 	CCMT 060202-FP	6,40	6,35	2,38	0,2	●	●																		
	CCMT 060204-FP	6,40	6,35	2,38	0,4	●	●																		
	CCMT 060208-FP	6,40	6,35	2,38	0,8	●	●																		
	CCMT 09T304-FP	9,70	9,52	3,97	0,4	●	●																		
	CCMT 09T308-FP	9,70	9,52	3,97	0,8	●	●																		
	CCMT 120404-FP	12,90	12,70	4,76	0,4	●	●																		
	CCMT 060202-FM	6,40	6,35	2,38	0,2						●	●													
	CCMT 060204-FM	6,40	6,35	2,38	0,4						●	●													
	CCMT 09T304-FM	9,70	9,52	3,97	0,4						●	●													

Bestellbeispiel Order example: 10 Stück 10 pieces CCGT 060202-BAL LC610T

Werkzeuge siehe Seiten 75-77 / 92 / 102 - 104
For tool holders see pages 75-77 / 92 / 102 - 104
Schnittdatenrichtwerte siehe ab Seite 124
For cutting data standard values see from page 124

● Verfügbar ab Lager Available from stock

	Bestellbezeichnung Ordering code	l	d	s	r	Sorte Grade											
						HC						HW/HCHW			HC		
						LCP15T	LCP25T	LC240F	LCM20T	LC435D	BCM25T	BCM40T	BCK10T	BCK20T	LW611	LC610T	LW610
CCMT...MM 	CCMT 060202-MM	6,40	6,35	2,38	0,2				●	●							
	CCMT 060204-MM	6,40	6,35	2,38	0,4				●	●							
	CCMT 09T304-MM	9,70	9,52	3,97	0,4				●	●							
	CCMT 09T308-MM	9,70	9,52	3,97	0,8				●	●							
	CCMT 120404-MM	12,90	12,70	4,76	0,4					●							
	CCMT 120408-MM	12,90	12,70	4,76	0,8					●							
CCMT...MK 	CCMT 09T304 MK	9,70	9,52	3,97	0,4						●	●					
	CCMT 09T308 MK	9,70	9,52	3,97	0,8						●	●					
	CCMT 120408 MK	12,90	12,70	4,76	0,8						●	●					
CCMT...MP 	CCMT 060202-MP	6,40	6,35	2,38	0,2	●	●										
	CCMT 060204-MP	6,40	6,35	2,38	0,4	●	●										
	CCMT 060208-MP	6,40	6,35	2,38	0,8	●	●										
	CCMT 09T304-MP	9,70	9,52	3,97	0,4	●	●										
	CCMT 09T308-MP	9,70	9,52	3,97	0,8	●	●										
	CCMT 120404-MP	12,90	12,70	4,76	0,4	●	●										
	CCMT 120408-MP	12,90	12,70	4,76	0,8	●	●										
CCMT...MT 	CCMT 09T304-MT	9,70	9,52	3,97	0,4										●	●	
CCMW... 	CCMW 09T304	9,70	9,52	3,97	0,4						●						

Bestellbeispiel Order example: 10 Stück 10 pieces CCMT 060202-MM LCM20T

Werkzeuge siehe Seiten 75-77 / 92 / 102 - 104
For tool holders see pages 75-77 / 92 / 102 - 104
Schnittdatenrichtwerte siehe ab Seite 124
For cutting data standard values see from page 124

● Verfügbar ab Lager Available from stock

 Bestellbezeichnung Ordering code	l	d	s	r	Sorte Grade															
					HC						HW			HC						
					LCP15T	LCP25T	LC240F	LCM20T	LC435D	BCM25T	BCM40T	BCK10T	BCK20T	LW611	LC610T	LW610	LC415X	LC415Z	BCS10T	BCS20T
CNGG....-BCU 	CNGG 120408-BCU	12,90	12,70	4,76	0,8	●	●													
CNGG...-FMS 	CNGG 120404-FMS	12,90	12,70	4,76	0,4														●	●
	CNGG 120408-FMS	12,90	12,70	4,76	0,8														●	●
	CNGG 120412-FMS	12,90	12,70	4,76	1,2														●	●
CNGG....-MS 	CNGG 120404-MS	12,90	12,70	4,76	0,4														●	
	CNGG 120408-MS	12,90	12,70	4,76	0,8														●	
	CNGG 120412-MS	12,90	12,70	4,76	1,2														●	
CNGG...-MRS 	CNGG 120408-MRS	12,90	12,70	4,76	0,8														●	●
	CNGG 120412-MRS	12,90	12,70	4,76	1,2														●	●

Bestellbeispiel Order example: 10 Stück 10 pieces CNGG 120408-BCU LC415Z

● Verfügbar ab Lager Available from stock

Werkzeuge siehe Seiten 64 / 68 / 94

For tool holders see pages 64 / 68 / 94

Schnittdatenrichtwerte siehe ab Seite 124

For cutting data standard values see from page 124

	Bestellbezeichnung Ordering code	l	d	s	r	Sorte Grade																	
						HC						HW/HCHW			HC								
						LCP15T	LCP25T	LC240F	LCM20T	LC435D	BCM25T	BCM40T	BCK10T	BCK20T	LW611	LC610T	LW610	LC415X	LC415Z	BCS10T	BCS20T		
CNMA 	CNMA 120408	12,90	12,70	4,76	0,8																		
	CNMA 120412	12,90	12,70	4,76	1,2																		
	CNMA 190616	19,30	19,05	6,35	1,6																		
CNMG....-BFMS 	CNMG 090304-BFMS	9,70	9,52	3,18	0,4				•	•	•												
	CNMG 120404-BFMS	12,90	12,70	4,76	0,4				•	•	•												
	CNMG 120408-BFMS	12,90	12,70	4,76	0,8				•	•	•												
	CNMG 120412-BFMS	12,90	12,70	4,76	1,2				•	•	•												
CNMG....-BMRS 	CNMG 120408-BMRS	12,90	12,70	4,76	0,8				•	•	•												
	CNMG 120412-BMRS	12,90	12,70	4,76	1,2				•	•	•												
	CNMG 160612-BMRS	16,10	15,87	6,35	1,2				•	•	•												
	CNMG 160616-BMRS	19,30	19,05	6,35	1,6						•	•											
	CNMG 190612-BMRS	19,30	19,05	6,35	1,2				•	•	•												
CNMG....-BMS 	CNMG 120408-BMS	12,90	12,70	4,76	0,8				•														
	CNMG 120412-BMS	12,90	12,70	4,76	1,2				•														
	CNMG 160612-BMS	16,10	15,87	6,35	1,2				•														
CNMG....E.-BC 	CNMG 120404 EL-BC	12,90	12,70	4,76	0,4		•	•		•													
	CNMG 120404 ER-BC	12,90	12,70	4,76	0,4		•			•													
	CNMG 120408 EL-BC	12,90	12,70	4,76	0,8		•	•		•													
	CNMG 120408 ER-BC	12,90	12,70	4,76	0,8		•	•		•													

Bestellbeispiel Order example: 10 Stück 10 pieces CNMA 120408 BCK10T

• Verfügbar ab Lager Available from stock

Werkzeuge siehe Seiten 64 -68 / 94 / 98

For tool holders see pages 64 -68 / 94 / 98

Schnittdatenrichtwerte siehe ab Seite 124







For cutting data standard values see from page 124

	Bestellbezeichnung Ordering code	l	d	s	r	Sorte Grade											
						HC						HW			HC		
						LCP15T	LCP25T	LC240F	LCM20T	LC435D	BCM25T	BCM40T	BCK10T	BCK20T	LW611	LC610T	LW610
CNMG....-FMP 	CNMG 120404-FMP	12,90	12,70	4,76	0,4	●	●										
	CNMG 120408-FMP	12,90	12,70	4,76	0,8	●	●	●									
CNMG....FP 	CNMG 120404-FP	12,90	12,70	4,76	0,4	●	●										
	CNMG 120408-FP	12,90	12,70	4,76	0,8	●	●										
CNMG...-HPT 	CNMG 120408-HPT	12,90	12,70	4,76	0,8	●	●										
	CNMG 120412-HPT	12,90	12,70	4,76	1,2	●	●										
CNMG....-MK 	CNMG 120404-MK	12,90	12,70	4,76	0,4												
	CNMG 120408-MK	12,90	12,70	4,76	0,8												
	CNMG 120412-MK	12,90	12,70	4,76	1,2												
	CNMG 120416-MK	12,90	12,70	4,76	1,6												

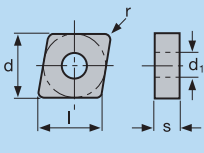
Bestellbeispiel Order example: 10 Stück 10 pieces CNMG 120404 FMP LCP15T

Werkzeuge siehe Seiten 64 / 68 / 94 / 98
 For tool holders see pages 64 / 68 / 94 / 98
 Schnittdatenrichtwerte siehe ab Seite 124
 For cutting data standard values see from page 124

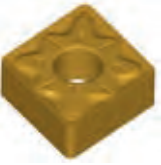
● Verfügbar ab Lager Available from stock

	Bestellbezeichnung Ordering code	l	d	s	r	Sorte Grade											
						HC				HW/HCHW				HC			
						LCP15T	LCP25T	LC240F	LCM20T	LC435D	BCM25T	BCM40T	BCK10T	BCK20T	LW611	LC610T	LW610
	CNMG 120408-MM	12,90	12,70	4,76	0,8				●		●	●					
	CNMG 120412-MM	12,90	12,70	4,76	1,2				●		●	●					
	CNMG 160612-MM	16,10	15,87	4,76	1,2				●		●	●					
	CNMG 160616-MM	16,10	15,87	6,35	1,6				●		●	●					
	CNMG 190612-MM	19,30	19,05	6,35	1,2				●		●	●					
	CNMG 190616-MM	19,30	19,05	6,35	1,6				●		●	●					
	CNMG 090308-MP	9,70	9,52	3,18	0,8	●	●	●									
	CNMG 120408-MP	12,90	12,70	4,76	0,8	●	●	●									
	CNMG 120412-MP	12,90	12,70	4,76	1,2	●	●	●									
	CNMG 120416-MP	12,90	12,70	4,76	1,6	●	●	●									
	CNMG 160608-MP	16,10	15,87	6,35	0,8	●	●	●									
	CNMG 160612-MP	16,10	15,87	6,35	1,2	●	●	●									
	CNMG 160616-MP	16,10	15,87	6,35	1,6	●	●	●									
	CNMG 190612-MP	19,30	19,05	6,35	1,2	●	●	●									
	CNMG 120408-MRK	12,90	12,70	4,76	0,8							●	●				
	CNMG 120412-MRK	12,90	12,70	4,76	1,2							●	●				
	CNMG 120416-MRK	12,90	12,70	4,76	1,6							●	●				
	CNMG 160612-MRK	16,10	16,10	6,35	1,2							●	●				
	CNMG 160616-MRK	16,10	16,10	6,35	1,6							●	●				
	CNMG 120408-MRM	12,90	12,70	4,76	0,8				●		●	●					
	CNMG 120412-MRM	12,90	12,70	4,76	1,2				●		●	●					
	CNMG 160608-MRM	16,10	15,87	6,35	0,8				●		●	●					
	CNMG 160612-MRM	16,10	15,87	6,35	1,2				●		●	●					
	CNMG 120408-MRP	12,90	12,70	4,76	0,8	●	●	●									
	CNMG 120412-MRP	12,90	12,70	4,76	1,2	●	●	●									
	CNMG 120416-MRP	12,90	12,70	4,76	1,6	●	●	●									
	CNMG 160608-MRP	16,10	15,87	6,35	0,8	●	●	●									
	CNMG 160612-MRP	16,10	15,87	6,35	1,2	●	●	●									
	CNMG 160616-MRP	16,10	15,87	6,35	1,6	●	●	●									
	CNMG 190612-MRP	19,30	19,05	6,35	1,2	●	●	●									
	CNMG 190616-MRP	19,30	19,05	6,35	1,6	●	●	●									
CNMG 190624-MRP	19,30	19,05	6,35	2,4	●	●	●										

Bestellbeispiel Order example: 10 Stück 10 pieces CNMG 120408-MM LCM20T

Werkzeuge siehe Seiten 64 / 68 / 94 / 98
For tool holders see pages 64 / 68 / 94 / 98
Schnittdatenrichtwerte siehe ab Seite 124
For cutting data standard values see from page 124

● Verfügbar ab Lager Available from stock

	Bestellbezeichnung Ordering code	l	d	s	r	Sorte Grade																						
						HC						HW			HC		HC											
						LCP15T	LCP25T	LC240F	LCM20T	LC435D	BCM25T	BCM40T	BCK10T	BCK20T	LW611	LC610T	LW610	LC415X	LC415Z	BCS10T	BCS20T							
CNMG....-MS 	CNMG 120404-MS	12,90	12,70	4,76	0,4																							
	CNMG 120408-MS	12,90	12,70	4,76	0,8																							
	CNMG 120412-MS	12,90	12,70	4,76	1,2																							
CNMG...-MT 	CNMG 120408-MT	12,90	12,70	4,76	0,8																							
CNMM....-RP 	CNMM 120408-RP	12,90	12,70	4,76	0,8	●	●	●																				
	CNMM 120412-RP	12,90	12,70	4,76	1,2	●	●	●																				
	CNMM 160612-RP	16,10	15,87	6,35	1,2	●	●	●																				
	CNMM 160616-RP	16,10	15,87	6,35	1,6	●	●	●																				
	CNMM 190612-RP	19,30	19,05	6,35	1,2	●	●	●																				
	CNMM 190616-RP	19,30	19,05	6,35	1,6	●	●	●																				
	CNMM 190624-RP	19,30	19,05	6,35	2,4	●	●	●																				
CNMM....-BR 	CNMM 190616-BR	19,30	19,05	6,35	1,6	●	●	●																				
CNMM....-BRP 	CNMM 250724-BRP	25,80	25,40	7,94	2,4	●	●	●																				
	CNMM 250924-BRP	25,80	25,40	9,52	2,4	●	●	●																				

Bestellbeispiel Order example: 10 Stück 10 pieces CNMG 120404-MS LC415Z

Werkzeuge siehe Seiten 64 / 68 / 94 / 98
 For tool holders see pages 64 / 68 / 94 / 98
 Schnittdatenrichtwerte siehe ab Seite 124
 For cutting data standard values see from page 124





● Verfügbar ab Lager Available from stock

	Bestellbezeichnung Ordering code	l	d	s	r	Sorte Grade													
						HC						HW/HCHW			HC				
						LCP15T	LCP25T	LC240F	LCM20T	LC435D	BCM25T	BCM40T	BCK10T	BCK20T	LW611	LC610T	LW610	LC415X	LC415Z
	DCGT 0702008	7,70	6,35	2,38	0,08														
	DCGT 0702015	7,70	6,35	2,38	0,15														
	DCGT 11T3015	11,60	9,52	3,97	0,15														
	DCGT 11T3035	11,60	9,52	3,97	0,35														
	DCGT 070202-BAL	7,70	6,35	2,38	0,2														
	DCGT 070204-BAL	7,70	6,35	2,38	0,4														
	DCGT 11T302-BAL	11,60	9,52	3,97	0,2														
	DCGT 11T304-BAL	11,60	9,52	3,97	0,4														
	DCGT 11T308-BAL	11,60	9,52	3,97	0,8														
	DCGT 070204 EL-BC	7,70	6,35	2,38	0,4														
	DCGT 070204 ER-BC	7,70	6,35	2,38	0,4														
	DCGT 11T304 EL-BC	11,60	9,52	3,97	0,4														
	DCGT 11T304 ER-BC	11,60	9,52	3,97	0,4														
	DCGT 11T308 EL-BC	11,60	9,52	3,97	0,8														
	DCGT 11T308 ER-BC	11,60	9,52	3,97	0,8														
	DCGT 0702008 FL-BC	7,70	6,35	2,38	0,08														
	DCGT 0702008 FR-BC	7,70	6,35	2,38	0,08														
	DCGT 0702015 FL-BC	7,70	6,35	2,38	0,15														
	DCGT 0702015 FR-BC	7,70	6,35	2,38	0,15														
	DCGT 11T3015 FL-BC	11,60	9,52	3,97	0,15														
	DCGT 11T3015 FR-BC	11,60	9,52	3,97	0,15														
	DCGT 11T3035 FL-BC	11,60	9,52	3,97	0,35														
	DCGT 11T3035 FR-BC	11,60	9,52	3,97	0,35														
	DCGT 04T002-FM	4,0	3,1	1,2	0,2														

Bestellbeispiel Order example: 10 Stück 10 pieces DCGT 0702008 LC415X

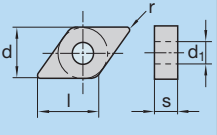
● Verfügbar ab Lager Available from stock

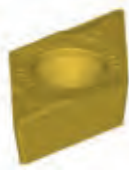



Werkzeuge siehe Seiten 78 / 79 / 92 / 105 -107
For tool holders see pages 78 / 79 / 92 / 105 - 107
Schnittdatenrichtwerte siehe ab Seite 124
For cutting data standard values see from page 124

		Bestellbezeichnung Ordering code				Sorte Grade																	
						HC						HW		HC									
						LCP15T	LCP25T	LC240F	LCM20T	LC435D	BCM25T	BCM40T	BCK10T	BCK20T	LW611	LC610T	LW610	LC415X	LC415Z	BCS10T	BCS20T		
DCGT....-P	DCGT 04T002-P	3,8	3,1	1,2	0,2																		
																							
DCMT....-BSMS	DCMT 11T304-BSMS	11,60	9,52	3,97	0,4																		
	DCMT 11T308-BSMS	11,60	9,52	3,97	0,8																		
DCMT....-F.	DCMT 070202-FP	7,70	6,35	2,38	0,2	•	•																
	DCMT 070204-FP	7,70	6,35	2,38	0,4	•	•																
	DCMT 11T302-FP	11,60	9,52	3,97	0,2	•	•																
	DCMT 11T304-FP	11,60	9,52	3,97	0,4	•	•																
	DCMT 070202-FM	7,70	6,35	2,38	0,2			•	•														
	DCMT 070204-FM	7,70	6,35	2,38	0,4					•	•												
	DCMT 11T302-FM	11,60	9,52	3,97	0,2			•	•														
	DCMT 11T304-FM	11,60	9,52	3,97	0,4					•	•												
DCMT....-MK	DCMT 070202-MK	7,70	6,35	2,38	0,2																		
	DCMT 070204-MK	7,70	6,35	2,38	0,4																		
	DCMT 11T304-MK	11,60	9,52	3,97	0,4																		
	DCMT 11T308-MK	11,60	9,52	3,97	0,8																		
DCMT....-MM	DCMT 070204-MM	7,70	6,35	2,38	0,4																		
	DCMT 11T304-MM	11,60	9,52	3,97	0,4																		
	DCMT 11T308-MM	11,60	9,52	3,97	0,8																		

Bestellbeispiel Order example: 10 Stück 10 pieces DCGT 040102-P LC610T

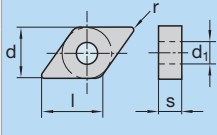
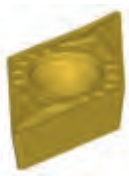
Werkzeuge siehe Seiten 78 / 79 / 92 / 105 - 107
 For tool holders see pages 78 / 79 / 92 / 105 - 107
 Schnittdatenrichtwerte siehe ab Seite 124
 For cutting data standard values see from page 124

• Verfügbar ab Lager Available from stock

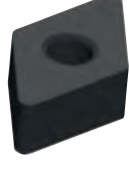
	Bestellbezeichnung Ordering code	l	d	s	r	Sorte Grade											
						HC						HW			HC		
						LCP15T	LCP25T	LC240F	LCM20T	LC435D	BCM25T	BCM40T	BCK10T	BCK20T	LW611	LC610T	LW610
DCMT....-MP 	DCMT 070204-MP	7,70	6,35	2,38	0,4	●	●										
	DCMT 11T304-MP	11,60	9,52	3,97	0,4	●	●										
	DCMT 11T308-MP	11,60	9,52	3,97	0,8	●	●										
DCMT...MT 	DCMT 11T304-MT	11,60	9,52	3,97	0,4											●	●
	DCMT 11T308-MT	11,60	9,52	3,97	0,8											●	●
DCMW.... 	DCMW 11T304	11,60	9,52	3,97	0,4											●	
	DCMW 11T308	11,60	9,52	3,97	0,8											●	
DNGG...-FMS 	DNGG 150404-FMS	15,50	12,70	4,76	0,4											●	●
	DNGG 150408-FMS	15,50	12,70	4,76	0,8											●	●
	DNGG 150412-FMS	15,50	12,70	4,76	1,2											●	●
	DNGG 150604-FMS	15,50	12,70	6,35	0,4											●	●
	DNGG 150608-FMS	15,50	12,70	6,35	0,8											●	●
	DNGG 150612-FMS	15,50	12,70	6,35	1,2											●	●
DNMA... 	DNMA 150608	15,50	12,70	6,35	0,8											●	
	DNMA 150612	15,50	12,70	6,35	1,2											●	

Bestellbeispiel Order example: 10 Stück 10 pieces DCMT 070204-MP LCP15T

Werkzeuge siehe Seiten 64 / 69 / 78 / 79 / 92 / 94 / 99 / 105 - 107
For tool holders see pages 64 / 69 / 78 / 79 / 92 / 94 / 99 / 105 - 107
Schnittdatenrichtwerte siehe ab Seite 124
For cutting data standard values see from page 124



● Verfügbar ab Lager Available from stock

	Bestellbezeichnung Ordering code	l	d	s	r	Sorte Grade													
						HC						HW			HC				
						LCP15T	LCP25T	LC240F	LCM20T	LC435D	BCM25T	BCM40T	BCK10T	BCK20T	LW611	LC610T	LW610	LC415X	LC415Z
	DNMG 110404-BFMS	11,60	9,52	4,76	0,4				●	●	●								
	DNMG 110408-BFMS	11,60	9,52	4,76	0,8														
	DNMG 150604-BFMS	15,50	12,70	6,35	0,4				●	●	●								
	DNMG 150608-BFMS	15,50	12,70	6,35	0,8				●	●	●								
	DNMG 150612-HPT	15,50	12,70	6,35	1,2	●	●												
	DNMG 150608-BMRS	15,50	12,70	6,35	0,8					●	●	●							
	DNMG 150612-BMRS	15,50	12,70	6,35	1,2					●	●	●							
	DNMG 110408-BMS	11,60	9,52	4,76	0,8					●									
	DNMG 150408-BMS	15,50	12,70	4,76	0,8					●									
	DNMG 150608-BMS	15,50	12,70	6,35	0,8					●									
	DNMG 150612-BMS	15,50	12,70	6,35	1,2					●									
	DNMG 110404 EL-BC	11,60	9,52	4,76	0,4	●	●	●											
	DNMG 110404 ER-BC	11,60	9,52	4,76	0,4	●	●	●											
	DNMG 110408 EL-BC	11,60	9,52	4,76	0,8	●	●	●											
	DNMG 110408 ER-BC	11,60	9,52	4,76	0,8	●	●	●											
	DNMG 150404 EL-BC	15,50	12,70	4,76	0,4		●												
	DNMG 150404 ER-BC	15,50	12,70	4,76	0,4		●												
	DNMG 150408 EL-BC	15,50	12,70	4,76	0,8		●												
	DNMG 150408 ER-BC	15,50	12,70	4,76	0,8		●												
	DNMG 150604 EL-BC	15,50	12,70	6,35	0,4	●	●	●		●									
	DNMG 150604 ER-BC	15,50	12,70	6,35	0,4	●	●	●		●									
DNMG 150608 EL-BC	15,50	12,70	6,35	0,8	●	●	●		●										
DNMG 150608 ER-BC	15,50	12,70	6,35	0,8	●	●	●		●										

Bestellbeispiel Order example: 10 Stück 10 pieces DNMG 110404-BFMS LCM20T

Werkzeuge siehe Seiten 64 / 69 / 94 / 99
For tool holders see pages 64 / 69 / 94 / 99
Schnittdatenrichtwerte siehe ab Seite 124
For cutting data standard values see from page 124

● Verfügbar ab Lager Available from stock

	Bestellbezeichnung Ordering code	l	d	s	r	Sorte Grade											
						HC						HW			HC		
						LCP15T	LCP25T	LC240F	LCM20T	LC435D	BCM25T	BCM40T	BCK10T	BCK20T	LW611	LC610T	LW610
	DNMG 110404-FMP	11,60	9,52	4,76	0,4	●	●	●									
	DNMG 110408-FMP	11,60	9,52	4,76	0,8	●	●										
	DNMG 150408-FMP	15,50	12,70	4,76	0,8		●										
	DNMG 150604-FMP	15,50	12,70	6,35	0,4	●	●	●									
	DNMG 150608-FMP	15,50	12,70	6,35	0,8	●	●	●									
	DNMG 110404-FP	11,60	9,52	4,76	0,4	●	●										
	DNMG 110408-FP	11,60	9,52	4,76	0,8	●	●										
	DNMG 150404-FP	15,50	12,70	4,76	0,4	●	●										
	DNMG 150408-FP	15,50	12,70	4,76	0,8	●	●										
	DNMG 150604-FP	15,50	12,70	6,35	0,4	●	●										
	DNMG 150608-FP	15,50	12,70	6,35	0,8	●	●										
	DNMG 110404-MK	11,60	9,52	4,76	0,4												
	DNMG 110408-MK	11,60	9,52	4,76	0,8												
	DNMG 150608-MK	15,50	12,70	6,35	0,8												
	DNMG 110408-MP	11,60	9,52	4,76	0,8	●	●	●									
	DNMG 150408-MP	15,50	12,70	4,76	0,8	●	●	●									
	DNMG 150412-MP	15,50	12,70	4,76	1,2	●	●	●									
	DNMG 150608-MP	15,50	12,70	6,35	0,8	●	●	●									
	DNMG 150612-MP	15,50	12,70	6,35	1,2	●	●	●									
	DNMG 150616-MP	15,50	12,70	6,35	1,6	●	●										
	DNMG 150608-MRK	15,50	12,70	4,76	0,8												
	DNMG 150612-MRK	15,50	12,70	4,76	1,2												
	DNMG 150408-MRP	15,50	12,70	4,76	0,8	●	●										
	DNMG 150412-MRP	15,50	12,70	4,76	1,2	●	●	●									
	DNMG 150608-MRP	15,50	12,70	6,35	0,8	●	●	●									
	DNMG 150612-MRP	15,50	12,70	6,35	1,2	●	●	●									
	DNMG 150616-MRP	15,50	12,70	6,35	1,6	●	●	●									
	DNMG 150608-MRM	15,50	12,70	6,35	0,8				●	●	●						
DNMG 150612-MRM	15,50	12,70	6,35	1,2				●	●	●							

Bestellbeispiel Order example: 10 Stück 10 pieces DNMG 110404-FMP LCP15T

Werkzeuge siehe Seiten 64 / 69 / 94 / 99
For tool holders see pages 64 / 69 / 94 / 99
Schnittdatenrichtwerte siehe ab Seite 124
For cutting data standard values see from page 124

● Verfügbar ab Lager Available from stock

	Bestellbezeichnung Ordering code	l	d	s	r	Sorte Grade											
						HC						HW			HC		
						LCP15T	LCP25T	LC240F	LCM20T	LC435D	BCM25T	BCM40T	BCK10T	BCK20T	LW611	LC610T	LW610
	DNMG 110404-MM	11,60	9,52	4,76	0,4												
	DNMG 110408-MM	11,60	9,52	4,76	0,8												
	DNMG 150404-MM	15,50	12,70	4,76	0,4				●								
	DNMG 150408-MM	15,50	12,70	4,76	0,8				●								
	DNMG 150604-MM	15,50	12,70	6,35	0,4				●	●							
	DNMG 150608-MM	15,50	12,70	6,35	0,8				●	●	●						
	DNMG 150612-MM	15,50	12,70	6,35	1,2				●	●	●						
	DNMG 150404-MS	15,50	12,70	4,76	0,4											●	
	DNMG 150408-MS	15,50	12,70	4,76	0,8											●	
	DNMG 150412-MS	15,50	12,70	4,76	1,2											●	
	DNMG 150604-MS	15,50	12,70	6,35	0,4											●	
	DNMG 150608-MS	15,50	12,70	6,35	0,8											●	
	DNMG 150612-MS	15,50	12,70	6,35	1,2											●	
	DNMG 150608-MT	15,50	12,70	6,35	0,8											●	●
	DNMG 140405TL20	14,00	11,95	4,76	0,5	●	●										
	DNMG 140405TR20	14,00	11,95	4,76	0,5	●	●										
	DNMG 140405TL25	14,00	11,95	4,76	0,5		●										
	DNMG 140405TR25	14,00	11,95	4,76	0,5	●	●										
	DNMG 140410TL25	14,00	11,95	4,76	1,0	●	●										
	DNMG 140410TR25	14,00	11,95	4,76	1,0	●	●										
	DNMM 150608-RP	15,50	12,70	6,35	0,8	●	●	●									
	DNMM 150612-RP	15,50	12,70	6,35	1,2	●	●	●									
	DNMM 150616-RP	15,50	12,70	6,35	1,6	●	●	●									

Bestellbeispiel Order example: 10 Stück 10 pieces DNMG 110404-MM LCM20T

Werkzeuge siehe Seiten 64 / 69 / 94 / 99
For tool holders see pages 64 / 69 / 94 / 99
Schnittdatenrichtwerte siehe ab Seite 124
For cutting data standard values see from page 124



● Verfügbar ab Lager Available from stock

 d s d ₁ r	Bestellbezeichnung Ordering code	l	d	s	r	Sorte Grade																
						HC							HW			HC						
						LCP15T	LCP25T	LC240F	LCM20T	LC435D	BCM25T	BCM40T	BCK10T	BCK20T	LW611	LC610T	LW610	LC415X	LC415Z	BCS10T	BCS20T	
RCGT....-BAL 	RCGT 0602MO-BAL	-	6,00	2,38	-											●	●					
	RCGT 0803MO-BAL	-	8,00	3,18	-											●	●					
	RCGT 1003MO-BAL	-	10,00	3,18	-											●	●					
	RCGT 1204MO-BAL	-	12,00	4,76	-											●	●					
RCMT....MO 	RCMT 0602MO	-	6,00	2,38	-											●						
RCMT...MT 	RCMT 1606-MT	-	16,00	6,35	-																●	
	RCMT 2006-MT	-	20,00	6,35	-																	●
RCMX....MO 	RCMX 1003MO	-	10,00	3,18	-			●														
	RCMX 1204MO	-	12,00	4,76	-			●	●												●	
	RCMX 1606MO	-	16,00	6,35	-	●	●	●														
	RCMX 2006MO	-	20,00	6,35	-	●	●	●			●	●										
	RCMX 2507MO	-	25,00	7,94	-	●	●	●			●											
	RCMX 3209MO	-	32,00	9,52	-	●	●	●														

Bestellbeispiel Order example: 10 Stück 10 pieces RCGT 0602MO-BAL LC610T

● Verfügbar ab Lager Available from stock

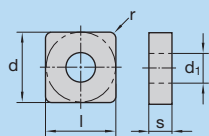
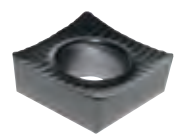
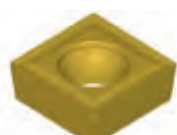
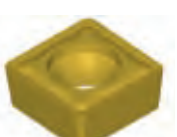
Werkzeuge siehe Seiten 70 / 80
For tool holders see pages 70 / 80
Schnittdatenrichtwerte siehe ab Seite 124
For cutting data standard values see from page 124

	Bestellbezeichnung Ordering code	l	d	s	r	Sorte Grade																
						HC						HW		HC								
						LCP15T	LCP25T	LC240F	LCM20T	LC435D	BCM25T	BCM40T	BCK10T	BCK20T	LW611	LC610T	LW610	LC415X	LC415Z	BCS10T	BCS20T	
SCGT...-BAL 	SCGT 120408-BAL	12,70	12,70	4,76	0,8																	
SCMT... 	SCMT 120404	12,70	12,70	4,76	0,4		●															
SCMT...-BSM 	SCMT 09T308-BSM SCMT 120408-BSM	9,52	9,52	3,97	0,8	●	●															
SCMT....-BSMR 	SCMT 250924-BSMR	25,40	25,40	9,52	2,4	●	●	●														
SCMT....-BSMS 	SCMT 120408-BSMS	12,70	12,70	4,76	0,8				●													

Bestellbeispiel Order example: 10 Stück 10 pieces SCGT 120408-BAL LC610T

Werkzeuge siehe Seiten 81 / 82
 For tool holders see pages 81 / 82
 Schnittdatenrichtwerte siehe ab Seite 124
 For cutting data standard values see from page 124





● Verfügbar ab Lager Available from stock

	Bestellbezeichnung Ordering code	l	d	s	r	Sorte Grade											
						HC						HW/HCHW			HC		
						LCP15T	LCP25T	LC240F	LCM20T	LC435D	BCM25T	BCM40T	BCK10T	BCK20T	LW611	LC610T	LW610
SCMT....-BSR 	SCMT 250916-BSR	25,40	25,40	9,52	1,6	●	●	●									
	SCMT 250924-BSR	25,40	25,40	9,52	2,4	●	●										
SCMT....-FP 	SCMT 09T304-FP	9,52	9,52	3,97	0,4	●	●										
	SCMT 09T308-FP	9,52	9,52	3,97	0,8	●	●										
	SCMT 120404-FP	12,70	12,70	4,76	0,4	●	●										
SCMT....-MK SCMT....-MP 	SCMT 120408-MK	12,70	12,70	4,76	0,8												
	SCMT 09T308-MP	9,52	9,52	3,97	0,8	●	●										
	SCMT 120408-MP	12,70	12,70	4,76	0,8	●	●										
	SCMT 120412-MP	12,70	12,70	4,76	1,2	●	●										
SCMW.... 	SCMW 09T304	9,52	9,52	3,97	0,4												
	SCMW 120404	12,70	12,70	4,76	0,4												
SNMA.... 	SNMA 120408	12,70	12,70	4,76	0,8												
	SNMA 120412	12,70	12,70	4,76	1,2												
	SNMA 120416	12,70	12,70	4,76	1,6												
	SNMA 190616	19,05	19,05	4,76	1,6												

Bestellbeispiel Order example: 10 Stück 10 pieces SCMT 2509216-BSR LCP15T

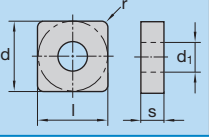
Werkzeuge siehe Seiten 64 / 66 / 71 - 72 / 81 - 82 / 100
 For tool holders see pages 64 / 66 / 71 - 72 / 81 - 82 / 100
 Schnittdatenrichtwerte siehe ab Seite 124
 For cutting data standard values see from page 124

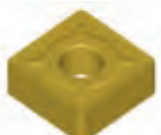
● Verfügbar ab Lager Available from stock

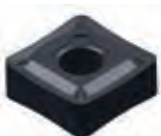
	Bestellbezeichnung Ordering code					Sorte Grade														
		l	d	s	r	HC				HW			HC							
						LCP15T	LCP25T	LC240F	LCM20T	LC435D	BCM25T	BCM40T	BCK10T	BCK20T	LW611	LC610T	LW610	LC415X	LC415Z	BCS10T
SNMG...-BFMS 	SNMG 090304-BFMS	9,52	9,52	3,18	0,4					●	●									
SNMG...-BMRS 	SNMG 120408-BMRS	12,70	12,70	4,76	0,8					●										
	SNMG 120412-BMRS	12,70	12,70	4,76	1,2					●	●									
	SNMG 190612-BMRS	19,05	19,05	6,35	1,2					●	●									
	SNMG 190616-BMRS	19,05	19,05	6,35	1,6						●									
SNMG...-BMS 	SNMG 120408-BMS	12,70	12,70	4,76	0,8						●									
	SNMG 120412-BMS	12,70	12,70	4,76	1,2						●									
SNMG....-FMP 	SNMG 090304-FMP	9,52	9,52	3,18	0,4	●	●													
SNMG....-FMS 	SNMG 120408-FMS	12,70	12,70	4,76	0,8														●	
	SNMG 120412-FMS	12,70	12,70	4,76	1,2														●	

Bestellbeispiel Order example: 10 Stück 10 pieces SNMG 090304-BFMS LC435D

● Verfügbar ab Lager Available from stock

Werkzeuge siehe Seiten 64 / 66 / 71 / 72 / 100
For tool holders see pages 64 / 66 / 71 / 72 / 100
Schnittdatenrichtwerte siehe ab Seite 124
For cutting data standard values see from page 124

	Bestellbezeichnung Ordering code	l	d	s	r	Sorte Grade											
						HC						HW			HC		
						LCP15T	LCP25T	LC240F	LCM20T	LC435D	BCM25T	BCM40T	BCK10T	BCK20T	LW611	LC610T	LW610
SNMG....-FP 	SNMG 120404-FP	12,70	12,70	4,76	0,4	●	●										
SNMG....-MM 	SNMG 120408-MM	12,70	12,70	4,76	0,8												
	SNMG 120412-MM	12,70	12,70	4,76	1,2												
	SNMG 150612-MM	15,87	15,87	6,35	1,2				●								
	SNMG 150616-MM	15,87	15,87	6,35	1,6				●								
	SNMG 190612-MM	19,05	19,05	6,35	1,2				●								
	SNMG 190616-MM	19,05	19,05	6,35	1,6				●								
SNMG....-MK SNMG....-MP 	SNMG 120408-MK	12,70	12,70	4,76	0,8												
	SNMG 120412-MK	12,70	12,70	4,76	1,2												
	SNMG 120408-MP	12,70	12,70	4,76	0,8	●	●	●									
	SNMG 120412-MP	12,70	12,70	4,76	1,2	●	●	●									
	SNMG 150608-MP	15,87	15,87	6,35	0,8	●	●	●									
	SNMG 190612-MP	19,05	19,05	6,35	1,2	●	●	●									
SNMG....-MRK 	SNMG 120408-MRK	12,70	12,70	4,76	0,8												
	SNMG 120412-MRK	12,70	12,70	4,76	1,2												
	SNMG 150612-MRK	15,87	15,87	4,76	1,2												
	SNMG 190612-MRK	19,05	19,05	6,35	1,2												
	SNMG 190616-MRK	19,05	19,05	6,35	1,6												
SNMG...-MRP 	SNMG 120408-MRP	12,70	12,70	4,76	0,8	●	●	●									
	SNMG 120412-MRP	12,70	12,70	4,76	1,2	●	●	●									
	SNMG 150608-MRP	15,87	15,87	6,35	0,8	●	●	●									
	SNMG 150612-MRP	15,87	15,87	6,35	1,2	●	●	●									
	SNMG 150616-MRP	15,87	15,87	6,35	1,6	●	●	●									
	SNMG 190612-MRP	19,05	19,05	6,35	1,2	●	●	●									
	SNMG 190616-MRP	19,05	19,05	6,35	1,6	●	●	●									

Bestellbeispiel Order example: 10 Stück 10 pieces SNMG 120404-FP LCP15T

● Verfügbar ab Lager Available from stock



Werkzeuge siehe Seiten 64 / 66 / 71 / 72 / 100
For tool holders see pages 64 / 66 / 71 / 72 / 100
Schnittdatenrichtwerte siehe ab Seite 124
For cutting data standard values see from page 124

	Bestellbezeichnung Ordering code	l	d	s	r	Sorte Grade													
						HC						HW			HC				
						LCP15T	LCP25T	LC240F	LCM20T	LC435D	BCM25T	BCM40T	BCK10T	BCK20T	LW611	LC610T	LW610	LC415X	LC415Z
SNMG....-MRS 	SNMG 120408-MRS	12,70	12,70	4,76	0,8														
	SNMG 120412-MRS	12,70	12,70	4,76	1,2														
SNMM...-BR 	SNMM 190616-BR	19,05	19,05	6,35	1,6	●	●	●											
	SNMM 190624-BR	19,05	19,05	6,35	2,4	●	●	●											
	SNMM 250724-BR	25,40	25,40	7,94	2,4		●	●											
	SNMM 250924-BR	25,40	25,40	9,52	2,4		●	●											
SNMM....-BRP 	SNMM 250724-BRP	25,40	25,40	7,94	2,4	●	●	●											
	SNMM 250732-BRP	25,40	25,40	7,94	3,2	●	●	●											
	SNMM 250924-BRP	25,40	25,40	9,52	2,4	●	●	●											
	SNMM 250932-BRP	25,40	25,40	9,52	3,2	●	●	●											
SNMM....-RP 	SNMM 120408-RP	12,70	12,70	4,76	0,8	●	●	●											
	SNMM 120412-RP	12,70	12,70	4,76	1,2	●	●	●											
	SNMM 150612-RP	15,87	15,87	6,35	1,2	●	●	●											
	SNMM 150616-RP	15,87	15,87	6,35	1,6	●	●	●											
	SNMM 190612-RP	19,05	19,05	6,35	1,2	●	●	●											
	SNMM 190616-RP	19,05	19,05	6,35	1,6	●	●	●											
	SNMM 190624-RP	19,05	19,05	6,35	2,4	●	●	●											
	SNMM 190632-RP	19,05	19,05	6,35	3,2		●	●											
	SNMM 250724-RP	25,40	25,40	7,94	2,4		●	●											
SNMM.... 	SNMM 250716	25,40	25,40	7,94	1,6			●											
	SNMM 250724	25,40	25,40	7,94	2,4		●	●											

Bestellbeispiel Order example: 10 Stück 10 pieces SNMG 120408-MRS LC415Z

Werkzeuge siehe Seiten 64 / 66 / 71 / 72 / 100
For tool holders see pages 64 / 66 / 71 / 72 / 100
Schnittdatenrichtwerte siehe ab Seite 124
For cutting data standard values see from page 124

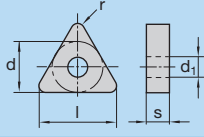
● Verfügbar ab Lager Available from stock

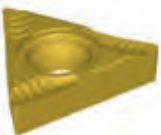
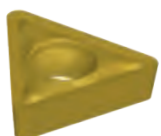
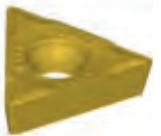
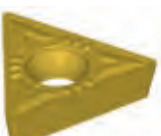
	Bestellbezeichnung Ordering code	l	d	s	r	Sorte Grade											
						HC				HW/HC			HW				
						LCP15T	LCP25T	LC240F	LCM20T	LC435D	BCM25T	BCM40T	BCK10T	BCK20T	LW611	LC610T	LW610
	TCGT 110204-BAL	11,00	6,35	2,38	0,4												
	TCGT 16T304-BAL	16,50	9,52	3,97	0,4												
	TCGT 110204 EL-BC	11,00	6,35	2,38	0,4	●	●		●								
	TCGT 110204 ER-BC	11,00	6,35	2,38	0,4	●											
	TCGT 16T304 EL-BC	16,50	9,52	3,97	0,4	●	●		●								
	TCGT 16T304 ER-BC	16,50	9,52	3,97	0,4	●	●		●								
	TCGT 16T308 EL-BC	16,50	9,52	3,97	0,8	●	●		●								
	TCGT 16T308 ER-BC	16,50	9,52	3,97	0,8	●	●		●								
	TCMT 110204-BSMS	11,00	6,35	2,38	0,4				●								
	TCMT 110208-BSMS	11,00	6,35	2,38	0,8				●								
	TCMT 16T304-BSMS	16,50	9,52	3,97	0,4				●								
	TCMT 16T308-BSMS	16,50	9,52	3,97	0,8				●								
	TCMT 110202-FP	11,00	6,35	2,38	0,2	●	●										
	TCMT 110204-FP	11,00	6,35	2,38	0,4	●	●										
	TCMT 110204-MP	11,00	6,35	2,38	0,4	●	●										
	TCMT 110208-MP	11,00	6,35	2,38	0,8	●	●										
	TCMT 16T304-MP	16,50	9,52	3,97	0,4	●	●										
	TCMT 16T308-MP	16,50	9,52	3,97	0,8	●	●										

Bestellbeispiel Order example: 10 Stück 10 pieces TCGT 110204-BAL LC610T

Werkzeuge siehe Seiten 83 / 84 / 108
For tool holders see pages 83 / 84 / 108
Schnittdatenrichtwerte siehe ab Seite 124
For cutting data standard values see from page 124







● Verfügbar ab Lager Available from stock

	Bestellbezeichnung Ordering code	l	d	s	r	Sorte Grade											
						HC						HW			HC		
						LCP15T	LCP25T	LC240F	LCM20T	LC435D	BCM25T	BCM40T	BCK10T	BCK20T	LW611	LC610T	LW610
TCMW... 	TCMW 110204	11,00	6,35	2,38	0,4												
	TCMW 16T304	16,50	9,52	3,97	0,4												
TNMA... 	TNMA 160408	16,50	9,52	4,76	0,8												
	TNMA 160412	16,50	9,52	4,76	1,2												
	TNMA 220416	22,00	12,70	4,76	1,6												
TNMG...-BFMS 	TNMG 160404-BFMS	16,50	9,52	4,76	0,4												
	TNMG 160408-BFMS	16,50	9,52	4,76	0,8												
TNMG....-BMS 	TNMG 160408-BMS	16,50	9,52	4,76	0,8												
	TNMG 160412-BMS	16,50	9,52	4,76	1,2												
	TNMG 220408-BMS	22,00	12,70	4,76	0,8												
	TNMG 220412-BMS	22,00	12,70	4,76	1,2												
TNMG....-E.-BC 	TNMG 160404 EL-BC	16,50	9,52	4,76	0,4	●	●	●									
	TNMG 160404 ER-BC	16,50	9,52	4,76	0,4	●	●	●									
	TNMG 160408 EL-BC	16,50	9,52	4,76	0,8	●	●	●									
	TNMG 160408 ER-BC	16,50	9,52	4,76	0,8	●	●	●									

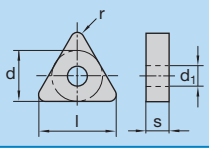
Bestellbeispiel Order example: 10 Stück 10 pieces TCMW 110204 LW611

Werkzeuge siehe Seiten 65 / 66 / 73 / 83 / 84 / 100 / 108
 For tool holders see pages 65 / 66 / 73 / 83 / 84 / 100 / 108
 Schnittdatenrichtwerte siehe ab Seite 124
 For cutting data standard values see from page 124

● Verfügbar ab Lager Available from stock

	Bestellbezeichnung Ordering code	l	d	s	r	Sorte Grade											
						HC						HW/HCHW			HC		
						LCP15T	LCP25T	LC240F	LCM20T	LC435D	BCM25T	BCM40T	BCK10T	BCK20T	LW611	LC610T	LW610
TNMG...-FMP 	TNMG 160404-FMP	16,50	9,52	4,76	0,4	●	●	●									
	TNMG 160408-FMP	16,50	9,52	4,76	0,8	●	●	●									
	TNMG 160412-FMP	16,50	9,52	4,76	1,2		●										
TNMG....-FP 	TNMG 160404 FP	16,50	9,52	4,76	0,4	●	●										
	TNMG 160408 FP	16,50	9,52	4,76	0,8	●	●										
TNMG....-MK TNMG....-MP 	TNMG 160408-MK	16,50	9,52	4,76	0,8												
	TNMG 160408-MP	16,50	9,52	4,76	0,8	●	●	●									
	TNMG 160412-MP	16,50	9,52	4,76	1,2	●	●	●									
	TNMG 160416-MP	16,50	9,52	4,76	1,6	●	●	●									
	TNMG 220408-MP	22,00	12,70	4,76	0,8	●	●	●									
TNMG 220412-MP	22,00	12,70	4,76	1,2	●	●											
TNMM....-RP 	TNMM 160408-RP	16,50	9,52	4,76	0,8	●	●	●									
	TNMM 220408-RP	22,00	12,70	4,76	0,8	●	●	●									
	TNMM 220412-RP	22,00	12,70	4,76	1,2	●	●	●									
TPMR...-FM 	TPMR 110304-FM	11,00	6,35	3,18	0,4	●	●	●									
	TPMR 110308-FM	11,00	6,35	3,18	0,8	●	●	●									
	TPMR 160304-FM	16,50	9,52	3,18	0,4	●	●	●									
	TPMR 160308-FM	16,50	9,52	3,18	0,8	●	●	●									

Bestellbeispiel Order example: 10 Stück 10 pieces TNMG 160404-FMP LCP15T

● Verfügbar ab Lager Available from stock

Werkzeuge siehe Seiten 65 / 66 / 73 / 100 / 113
For tool holders see pages 65 / 66 / 73 / 100 / 113
Schnittdatenrichtwerte siehe ab Seite 124
For cutting data standard values see from page 124

	Bestellbezeichnung Ordering code	l	d	s	r	Sorte Grade											
						HC						HW			HC		
						LCP15T	LCP25T	LC240F	LCM20T	LC435D	BCM25T	BCM40T	BCK10T	BCK20T	LW611	LC610T	LW610
	VCGT 110302-BAL	11,10	6,35	3,18	0,2												
	VCGT 110304-BAL	11,10	6,35	3,18	0,4												
	VCGT 160402-BAL	16,60	9,52	4,76	0,2												
	VCGT 160404-BAL	16,60	9,52	4,76	0,4												
	VCGT 160408-BAL	16,60	9,52	4,76	0,8												
	VCGT 160412-BAL	16,60	9,52	4,76	1,2												
	VCGT 220530-BAL	22,10	12,70	5,56	3,0												
	VCGT 050102-FM	5,40	3,10	1,59	0,2												
	VCGT 050102-P	5,40	3,10	1,59	0,2												
	VCGT 070202-P	6,85	3,97	2,38	0,2												
	VCGT 070204-P	6,85	3,97	2,38	0,4												
	VCGT 110302-P	11,10	6,37	3,18	0,2												
	VCGT 110304-P	11,10	6,37	3,18	0,4												
	VCGT 160404-P	16,60	9,52	4,76	0,4												
	VCGT 160408-P	16,60	9,52	4,76	0,8												
	VCMT 160404-BSMS	16,60	9,52	4,76	0,4												
	VCMT 160408-BSMS	16,60	9,52	4,76	0,8												
	VCMT 160412-BSMS	16,60	9,52	4,76	1,2												
	VCMT 070202-FP	6,85	3,97	2,38	0,2												
	VCMT 070204-FP	6,85	3,97	2,38	0,4												
	VCMT 110302-FP	11,10	6,37	3,18	0,2												
	VCMT 110304-FP	11,10	6,35	3,18	0,4												
	VCMT 160404-FP	16,60	9,52	4,76	0,4												
	VCMT 160408-FP	16,60	9,52	4,76	0,8												
	VCMT 070202-FM	6,85	3,97	2,38	0,2												
	VCMT 070204-FM	6,85	3,97	2,38	0,4												
	VCMT 110302-FM	11,10	6,35	3,18	0,2												
	VCMT 110304-FM	11,10	6,35	3,18	0,4												

Bestellbeispiel Order example: 10 Stück 10 pieces VCGT 110302-BAL LC610T

Werkzeuge siehe Seiten 85-87 / 93 / 108 - 111
For tool holders see pages 85-87 / 93 / 108 - 111
Schnittdatenrichtwerte siehe ab Seite 124
For cutting data standard values see from page 124



● Verfügbar ab Lager Available from stock



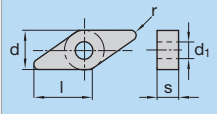

	Bestellbezeichnung Ordering code	l	d	s	r	Sorte Grade													
						HC						HW			HC				
						LCP15T	LCP25T	LC240F	LCM20T	LC435D	BCM25T	BCM40T	BCK10T	BCK20T	LW611	LC610T	LW610	LC415X	LC415Z
	VCMT 160404-MP	16,60	9,52	4,76	0,4	●	●												
	VCMT 160408-MP	16,60	9,52	4,76	0,8	●	●												
	VCMT 160404-MM	16,60	9,52	4,76	0,4				●		●								
	VCMT 160408-MM	16,60	9,52	4,76	0,8				●		●								
	VCMT 160412-MM	16,60	9,52	4,76	1,2						●								
	VNMG 160404-FP	16,60	9,52	4,76	0,4	●	●												
	VNMG 160408-FP	16,60	9,52	4,76	0,8	●	●												
	VNMG 160408-FMP	16,60	9,52	4,76	0,8	●	●												
	VNMG 160404-FMS	16,60	9,52	4,76	0,4													●	
	VNMG 160408-FMS	16,60	9,52	4,76	0,8													●	
	VNMG 160408-MP	16,60	9,52	4,76	0,8	●	●	●											
	VNMG 160412-MP	16,60	9,52	4,76	1,2	●	●	●											

Bestellbeispiel Order example: 10 Stück 10 pieces VCMT 160404-MP LCP15T

● Verfügbar ab Lager Available from stock

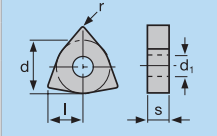
Werkzeuge siehe Seiten 67 / 85-87 / 93 / 109
For tool holders see pages 67 / 85-87 / 93 / 109
Schnittdatenrichtwerte siehe ab Seite 124
For cutting data standard values see from page 124

	Bestellbezeichnung Ordering code					Sorte Grade																
		l	d	s	r	HC						HW HC HW			HC							
						LCP15T	LCP25T	LC240F	LCM20T	LC435D	BCM25T	BCM40T	BCK10T	BCK20T	LW611	LC610T	LW610	LC415X	LC415Z	BCS10T	BCS20T	
<p>VPGT....-BAL</p> 	VPGT 220516-BAL	22,10	12,70	5,56	1,6												●					

	Bestellbezeichnung Ordering code					Sorte Grade																	
		l	d	s	r	HC						HW HC HW			HC								
						LCP15T	LCP25T	LC240F	LCM20T	LC435D	BCM25T	BCM40T	BCK10T	BCK20T	LW611	LC610T	LW610	LC415X	LC415Z	BCS10T	BCS20T		
<p>WCGT....-BAL</p> 	WCGT 06T302-BAL	6,50	9,52	3,97	0,2												●						
	WCGT 06T304-BAL	6,50	9,52	3,97	0,4												●	●					
	WCGT 06T308-BAL	6,50	9,52	3,97	0,8												●	●					
	WCGT 080404-BAL	8,60	12,70	4,76	0,4												●	●					
	WCGT 080408-BAL	8,60	12,70	4,76	0,8												●	●					
<p>WNGG....-FMS</p> 	WNGG 060408-FMS	6,50	9,52	4,76	0,8																	●	
	WNGG 080404-FMS	8,60	12,70	4,76	0,4																		●
	WNGG 080408-FMS	8,60	12,70	4,76	0,8																		●
	WNGG 080412-FMS	8,60	12,70	4,76	1,2																		●
<p>WNGG...-MS</p> 	WNGG 080404-MS	8,60	12,70	4,76	0,4																	●	
	WNGG 080408-MS	8,60	12,70	4,76	0,8																		●
	WNGG 080412-MS	8,60	12,70	4,76	1,2																		●

Bestellbeispiel Order example: 10 Stück 10 pieces VPGT 220516-BAL LW610

Werkzeuge siehe Seiten 65 / 67 / 74 / 88 / 95 / 101 / 112
For tool holders see pages 65 / 67 / 74 / 88 / 95 / 101 / 112
Schnittdatenrichtwerte siehe ab Seite 124
For cutting data standard values see from page 124







● Verfügbar ab Lager Available from stock

	Bestellbezeichnung Ordering code	l	d	s	r	Sorte Grade																		
						HC						HW			HC									
						LCP15T	LCP25T	LC240F	LCM20T	LC435D	BCM25T	BCM40T	BCK10T	BCK20T	LW611	LC610T	LW610	LC415X	LC415Z	BCS10T	BCS20T			
WNMA... 	WNMA 080408	8,60	12,70	4,76	0,8																			
	WNMA 080412	8,60	12,70	4,76	1,2																			
WNMG...-BFMS 	WNMG 060404-BFMS	6,50	9,52	4,76	0,4																			
	WNMG 080404-BFMS	8,60	12,70	4,76	0,4																			
	WNMG 080408-BFMS	8,60	12,70	4,76	0,8																			
WNMG...-BMRS 	WNMG 080408-BMRS	8,60	12,70	4,76	0,8																			
	WNMG 080412-BMRS	8,60	12,70	4,76	1,2																			
WNMG...-BMS 	WNMG 060408-BMS	6,50	9,52	4,76	0,8																			
	WNMG 080408-BMS	8,60	12,70	4,76	0,8																			
	WNMG 080412-BMS	8,60	12,70	4,76	1,2																			
	WNMG 080416-BMS	8,60	12,70	4,76	1,6																			
WNMG...-E.-BC 	WNMG 080404 ER-BC	8,60	12,70	4,76	0,4																			
	WNMG 080408 EL-BC	8,60	12,70	4,76	0,8																			
	WNMG 080408 ER-BC	8,60	12,70	4,76	0,8																			
	WNMG 080412 EL-BC	8,60	12,70	4,76	1,2																			
	WNMG 080412 ER-BC	8,60	12,70	4,76	1,2																			

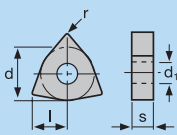
Bestellbeispiel Order example: 10 Stück 10 pieces WNMA 080408 BCK10T

● Verfügbar ab Lager Available from stock

Werkzeuge siehe Seiten 65 / 67 / 74 / 95 / 101
 For tool holders see pages 65 / 67 / 74 / 95 / 101
 Schnittdatenrichtwerte siehe ab Seite 124
 For cutting data standard values see from page 124

	Bestellbezeichnung Ordering code	l	d	s	r	Sorte Grade											
						HC						HW/HCHW			HC		
						LCP15T	LCP25T	LC240F	LCM20T	LC435D	BCM25T	BCM40T	BCK10T	BCK20T	LW611	LC610T	LW610
	WNMG 060404-FMP	6,50	9,52	4,76	0,4	●	●	●									
	WNMG 060408-FMP	6,50	9,52	4,76	0,8	●	●										
	WNMG 080404-FMP	8,60	12,70	4,76	0,4	●	●	●									
	WNMG 080408-FMP	8,60	12,70	4,76	0,8	●	●	●									
	WNMG 080408-HPT	8,60	12,70	4,76	0,8	●	●										
	WNMG 080412-HPT	8,60	12,70	4,76	1,2	●	●										
	WNMG 060404-MM	6,50	9,52	4,76	0,4						●						
	WNMG 080408-MM	8,60	12,70	4,76	0,8			●		●							
	WNMG 080412-MM	8,60	12,70	4,76	1,2			●		●							
	WNMG 080416-MM	8,60	12,70	4,76	1,6					●							
	WNMG 060408-MK	6,50	9,52	4,76	0,8							●	●				
	WNMG 080404-MK	8,60	12,70	4,76	0,4							●	●				
	WNMG 080408-MK	8,60	12,70	4,76	0,8							●	●				
	WNMG 080412-MK	8,60	12,70	4,76	1,2							●	●				
	WNMG 060408-MP	8,60	9,52	4,76	0,8	●	●	●									
	WNMG 080408-MP	8,60	12,70	4,76	0,8	●	●	●									
	WNMG 080412-MP	8,60	12,70	4,76	1,2	●	●	●									
	WNMG 080416-MP	8,60	12,70	4,76	1,6	●	●										

Bestellbeispiel Order example: 10 Stück 10 pieces WNMG 060404-FMP LCP15T

● Verfügbar ab Lager Available from stock

Werkzeuge siehe Seiten 65 / 67 / 74 / 95 / 101
For tool holders see pages 65 / 67 / 74 / 95 / 101
Schnittdatenrichtwerte siehe ab Seite 124
For cutting data standard values see from page 124

	Bestellbezeichnung Ordering code	l	d	s	r	Sorte Grade														
						HC						HW			HC					
						LCP15T	LCP25T	LC240F	LCM20T	LC435D	BCM25T	BCM40T	BCK10T	BCK20T	LW611	LC610T	LW610	LC415X	LC415Z	BCS10T
WNMG....-MRK WNMG....-MRP 	WNMG 080408-MRK	8,60	12,70	4,76	0,8															
	WNMG 080412-MRK	8,60	12,70	4,76	1,2															
	WNMG 080408-MRP	8,60	12,70	4,76	0,8	●	●	●												
	WNMG 080412-MRP	8,60	12,70	4,76	1,2	●	●	●												
	WNMG 080416-MRP	8,60	12,70	4,76	1,6	●	●	●												
WNMG....-MS 	WNMG 080404-MS	8,60	12,70	4,76	0,4													●		
	WNMG 080408-MS	8,60	12,70	4,76	0,8														●	
	WNMG 080412-MS	8,60	12,70	4,76	1,2														●	
WNMG...-MT 	WNMG 080408-MT	8,60	12,70	4,76	0,8														● ●	
WNMG...-MRM 	WNMG 080408-MRM	8,60	12,70	4,76	0,8				●		●	●								
	WNMG 080412-MRM	8,60	12,70	4,76	1,2				●		●	●								

Bestellbeispiel Order example: 10 Stück 10 pieces WNMG 080408-MRK BCK10T

Werkzeuge siehe Seiten 65 / 67 / 74 / 95 / 101
 For tool holders see pages 65 / 67 / 74 / 95 / 101
 Schnittdatenrichtwerte siehe ab Seite 124
 For cutting data standard values see from page 124

	Bestellbezeichnung Ordering code	l	d	s	r	Sorte Grade															
						HC						HW			HC						
						LCP15T	LCP25T	LC240F	LCM20T	LC435D	BCM25T	BCM40T	BCK10T	BCK20T	LW611	LC610T	LW610	LC415X	LC415Z	BCS10T	BCS20T
XCGT...-P 	XCGT 260407-P	-	9,52	4,76	0,7														●		
	XCGT 260410-P	-	9,52	4,76	1,0															●	
	XCGT 280408-P	-	9,45	4,76	0,8															●	

Bestellbeispiel Order example: 10 Stück 10 pieces XCGT 260407-P LW610

Werkzeuge siehe Seiten 89
 For tool holders see pages 89
 Schnittdatenrichtwerte siehe ab Seite 124
 For cutting data standard values see from page 124

● Verfügbar ab Lager Available from stock

Klemmhalter
Außenbearbeitung
Tool holders
external machining



D-Klemmhalter Außenbearbeitung
Tool holders type D, external machining

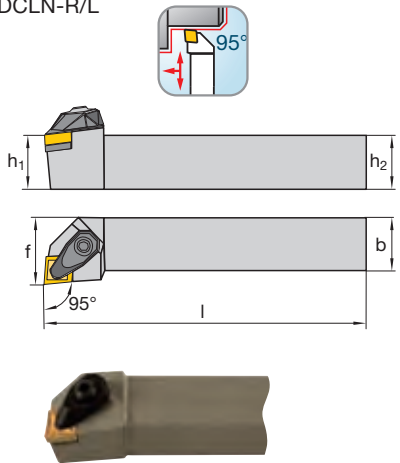
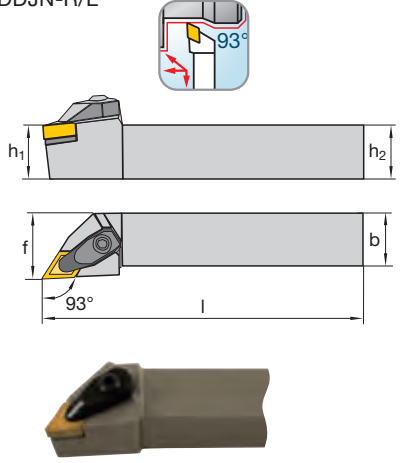
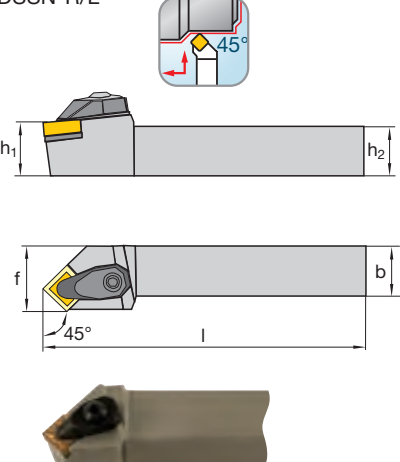

	Bestellbezeichnung Ordering Code	Ident No.	h_1 = h_2	b	f	l	Verfüg- barkeit Availability	Passende Wende- platten Suitable inserts	Seite Page
DCLN-R/L 	DCLNR 2020 K12	5009529	20	20	25	125	●	CN... 1204..	36-40
	DCLNL 2020 K12	5009531	20	20	25	125	○		
	DCLNR 2525 M12	5009454	25	25	32	150	●		
	DCLNL 2525 M12	5009455	25	25	32	150	●		
DDJN-R/L 	DDJNR 2020 K15	5009527	20	20	25	125	●	DN... 1506..	43-46
	DDJNL 2020 K15	5009528	20	20	25	125	○		
	DDJNR 2525 M15	5009452	25	25	32	150	●		
	DDJNL 2525 M15	5009453	25	25	32	150	●		
DSSN-R/L 	DSSNR 2020 K12	5009462	20	20	25	125	●	SN... 1204..	49-52
	DSSNL 2020 K12	5009463	20	20	25	125	○		
	DSSNR 2525 M12	5009456	25	25	32	150	●		
	DSSNL 2525 M12	5009457	25	25	32	150	○		

Rechtsausführung wie gezeichnet, Linksausführung spiegelbildlich
 Righthand version as shown, lefthand version mirrorlike

Bestellbeispiel: 1 Stück DCLNR 2020 K12
 Order example: 1 piece DCLNR 2020 K12

- Verfügbar ab Lager Available from stock
- Auf Anfrage On request

D-Klemmhalter Außenbearbeitung
Tool holders type D, external machining



	Bestellbezeichnung Ordering Code	Ident No.	h_1 = h_2	b	f	l	Verfüg- barkeit Availability	Passende Wende- platten Suitable inserts	Seite Page
DTJNR 	DTJNR 2020 K16	5009460	20	20	25	125	●	TN... 1604..	54-55
	DTJNL 2020 K16	5009461	20	20	25	125	○		
	DTJNR 2525 M16	5009285	25	25	32	150	●		
	DTJNL 2525 M16	5009451	25	25	32	150	○		
DWLNR 	DWLNR 2020 K08	5009459	20	20	25	125	●	WN... 0804..	59-62
	DWLNL 2020 K08	5009458	20	20	25	125	○		
	DWLNR 2525 M08	5009284	25	25	32	150	●		
	DWLNL 2525 M08	5009283	25	25	32	150	●		

Rechtsausführung wie gezeichnet, Linksausführung spiegelbildlich
 Righthand version as shown, lefthand version mirrorlike







Ersatzteile Spare parts	Bestellbezeichnung Ordering Code									
		M6210	V6020	V01-A0030					Symbolfoto!	
DCLNR/L 2020 K12	5013589	DT01N	5013609	5013595	5013610	5013607	VD0408	5013600	S8012P	
DCLNR/L 2525 M12	5013589	DT01N	5013609	5013595	5013610	5013607	VD0408	5013600	S8012P	
DDJNR/L 2020 K15	5013591	DT02N	5013609	5013595	5013610	5013607	VD0408	5013601	S5515P	
DDJNR/L 2525 M15	5013591	DT02N	5013609	5013595	5013610	5013607	VD0408	5013601	S5515P	
DSSNR/L 2020 K12	5013589	DT01N	5013609	5013595	5013610	5013607	VD0408	5013604	S9012P	
DSSNR/L 2525 M12	5013589	DT01N	5013609	5013595	5013610	5013607	VD0408	5013604	S9012P	
DTJNR/L 2020 K16	5013594	DT03N	5013609	5013595	5013610	5013608	VD0308	5013602	S6016D	
DTJNR/L 2525 M16	5013594	DT03N	5013609	5013595	5013610	5013608	VD0308	5013602	S6016D	
DWLNR/L 2020 K08	5013589	DT01N	5013609	5013595	5013610	5030344	VD0408B	5013603	S8008P	
DWLNR/L 2525 M08	5013589	DT01N	5013609	5013595	5013610	5030344	VD0408B	5013603	S8008P	

Bestellbeispiel: 1 Stück DTJNR 2020 K16
 Order example: 1 piece DTJNR 2020 K16

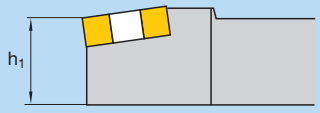
- Verfügbar ab Lager Available from stock
- Auf Anfrage On request

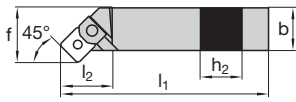
M-Klemmhalter Außenbearbeitung
Tool holders type M, external machining

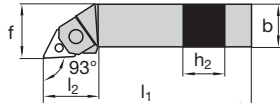

 h ₁	Bestellbezeichnung Ordering Code		Ident No.	h ₁ = h ₂	b	l ₁	l ₂	f	Verfügbarkeit Availability	Passende Wende- platten Suitable inserts	Seite Page
	MSSN-R/L	MSSNR 3232P19	6406095	32	32	170	44	40			
  	MSSNL 3232P19	6406094	32	32	170	44	40	○			
	MTJN-R/L	MTJNR 2020K16	6406122	20	20	125	34	25	●	TN.. 16..	54-55
  	MTJNL 2020K16	6406118	20	20	125	34	25	○			
	MTJNR 2525M16	6406123	25	25	150	34	32	●			
	MTJNL 2525M16	6406119	25	25	150	34	32	●			
	MTJNR 2525M22	6406124	25	25	150	35	32	●	TN.. 22..	54-55	
	MTJNL 2525M22	6406120	25	25	150	35	32	●			
	MTJNR 3225P22	6406125	32	25	170	35	40	○			
	MTJNL 3225P22	6406121	32	25	170	35	40	○			

Rechtsausführung wie gezeichnet, Linksausführung spiegelbildlich
 Righthand version as shown, lefthand version mirrorlike

Ersatzteile Spare parts MSSNR/L..		Bestellbezeichnung Ordering Code					
Schneid- kantenlänge Cutting edge length	Schaftgröße Shank size	 Unterlage Shim	 Spannpratzen- satz Clampset	 Schraube Screw	 Stift Pin	 Schlüssel Key	
19	3232	B08-S1847	D08-S19SP*	A11-05008	E08-07925	V01-A0040	

Ersatzteile Spare parts MTJNR/L..		Bestellbezeichnung Ordering Code					
Schneid- kantenlänge Cutting edge length	Schaftgröße Shank size	 Unterlage Shim	 Spannpratzen- satz Clampset	 Gewindestift Threadpin	 Stift Pin	 Schlüssel Key	
16	2020-2525	B08-13416	D08-12016*	-	E08-11645	V01-A0050	
22	2525-3225	B08-T2047	D08-T22SP	A01-06100	E08-051K8	V01-A0030	

Bestellbeispiel: 1 Stück MSSNR 3232P19
 Order example: 1 piece MSSNR 3232P19

Lieferung ohne Schlüssel
 Delivery without key

*Spannpratze und Schraube Sonderausführung/Set
 Clampset with screw special edition/set

- Verfügbar ab Lager Available from stock
- Auf Anfrage On request

M-Klemmhalter Außenbearbeitung
Tool holders type M, external machining



	Bestellbezeichnung Ordering Code		h ₁ = h ₂	b	l ₁	l ₂	f	Verfüg- barkeit Availa- bility	Passende Wende- platten Suitable inserts	Seite Page
	Ident No.									
MVJN-R/L 	MVJNR 2020K16	5110666	20	20	125	42	26	●	VN.. 16	58
	MVJNL 2020K16	5110667	20	20	125	42	26	●		
	MVJNR 2525M16	6418107	25	25	150	42	52	●		
	MVJNL 2525M16	5110668	25	25	150	42	52	●		
MVVNN 	MVVNN 2020K16	5110669	20	20	125	46	10	●	VN.. 16	58
	MVVNN 2525M16	5110670	25	25	150	46	12,5	●		
MWLN-R/L 	MWLN R 2020K06	6406136	20	20	125	26	25	●	WN.. 06..	59-61
	MWLN L 2020K06	6406127	20	20	125	26	25	○		
	MWLN R 2525M06	6406139	25	25	150	26	32	●		
	MWLN L 2525M06	6406130	25	25	150	26	32	●		
	MWLN R 3225P06	6406142	32	25	170	26	32	○		
	MWLN L 3225P06	6406133	32	25	170	26	32	○		
	MWLN R 2020K08	6406138	20	20	125	34	25	●	WN.. 08..	59-62
	MWLN L 2020K08	6406129	20	20	125	34	25	●		
	MWLN R 2525M08	6406141	25	25	150	34	32	●		
	MWLN L 2525M08	6406132	25	25	150	34	32	●		
	MWLN R 3225P08	6406143	32	25	170	34	32	○		
	MWLN L 3225P08	6406134	32	25	170	34	32	○		

Rechtsausführung wie gezeichnet, Linksausführung spiegelbildlich
 Righthand version as shown, lefthand version mirrorlike

Ersatzteile Spare parts MWLN R/L..		Bestellbezeichnung Ordering Code				
Schneid- kantenlänge Cutting edge length	Schaftgröße Shank size					
		Unterlage Shim	Spannpratzen- satz Clampset	Schraube Screw	Stift Pin	Schlüssel Key
06	2020-3225	B08-W0632	D08-W06SP	A14-30006	E08-05610	V01-A0020
08	2020-3225	B01-W0831	D08-12008*	-	E08-11662	V01-A0025
Ersatzteile Spare parts MV.NR/L..						
16	2020-2525	B09-V1633	Bm56018	Bm56017	E08-03713	V02-T1500

Bestellbeispiel: 1 Stück MVJNR 2020K16
 Order example: 1 piece MVJNR 2020K16

Lieferung ohne Schlüssel
 Delivery without key

*Spannpratze und Schraube Sonderausführung/Set
 Clampset with screw special edition/set

- Verfügbar ab Lager Available from stock
- Auf Anfrage On request

P-Klemmhalter Außenbearbeitung
Tool holders type P, external machining

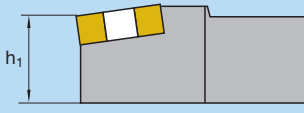
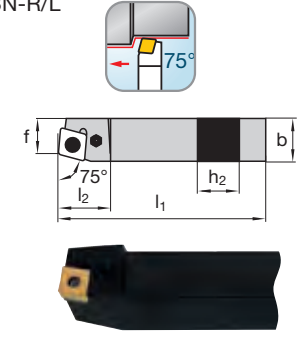
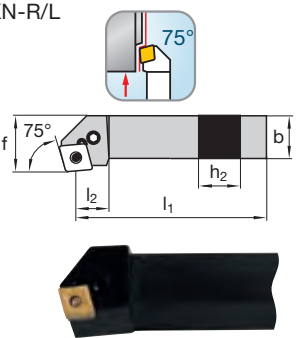
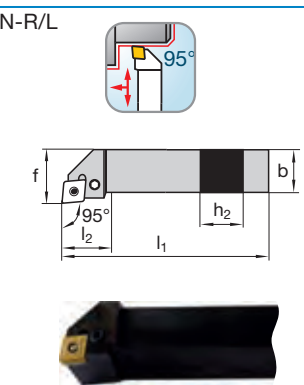

	Bestellbezeichnung Ordering Code		Ident No.	$h_1 = h_2$	b	l_1	l_2	f	Verfügbarkeit Availability	Passende Wendeplatten Suitable inserts	Seite Page
	PCBN-R/L	PCBNR 2525M12	6406213	25	25	150	27,7	22			
		PCBNL 2525M12	6406210	25	25	150	27,7	22	●		
		PCBNR 2525M16	6406214	25	25	150	31,7	22	○	CN.. 16..	
		PCBNL 2525M16	6406211	25	25	150	31,7	22	○		
		PCBNR 3232P19	6406216	32	32	170	37,9	27	●	CN.. 19..	
		PCBNL 3232P19	6406212	32	32	170	37,9	27	●		
		PCKNR 2525M12	6406219	25	25	150	28	32	●	CN.. 12..	36-40
		PCKNL 2525M12	6406217	25	25	150	28	32	●		
		PCKNR 2525M16	5110665	25	25	150	28	32	○	CN.. 16..	
		PCKNL 2525M16	5110664	25	25	150	28	32	○		
		PCKNR 3232P19	6406220	32	32	170	36	40	●	CN.. 19..	
		PCKNL 3232P19	6406218	32	32	170	36	40	●		
		PCLNR 1616H09	6406232	16	16	100	23	20	○	CN.. 09..	36-40
		PCLNL 1616H09	6406221	16	16	100	23	20	○		
		PCLNR 1616H12	6406233	16	16	100	26,1	20	●	CN.. 12..	
		PCLNL 1616H12	6406222	16	16	100	26,1	20	●		
		PCLNR 2020K12	6406234	20	20	125	27,4	25	●		
		PCLNL 2020K12	6406223	20	20	125	27,4	25	●		
		PCLNR 2525M12	6406235	25	25	150	28	32	●		
		PCLNL 2525M12	6406224	25	25	150	38	32	●		
		PCLNR 3225P12	6406238	32	32	170	38	40	●	CN.. 16..	
		PCLNL 3225P12	6406227	32	25	170	38	40	●		
		PCLNR 2525M16	6406236	25	25	150	28	32	●		
		PCLNL 2525M16	6406225	25	25	150	28	32	●		
		PCLNR 3232P16	6406239	32	32	170	32,6	40	●		
		PCLNL 3232P16	6406229	32	32	170	32,6	40	●		
		PCLNR 2525M19	6406237	25	25	150	38	32	○	CN.. 19..	
		PCLNL 2525M19	6406226	25	25	150	38	32	○		
		PCLNR 3232P19	6406240	32	32	170	38	40	●		
		PCLNL 3232P19	6406230	32	32	170	38	40	●		
	PCLNR 3225P19	6406228	32	25	170	38	40	○			
	PCLNL 4040S19	6406241	40	40	250	38	50	●			
	PCLNL 4040S19	6406231	40	40	250	38	50	●			

Rechtsausführung wie gezeichnet, Linksausführung spiegelbildlich Righthand version as shown, lefthand version mirrorlike

Ersatzteile Spare parts		Bestellbezeichnung Ordering Code					
PC.NR/L							
Schneidkantenlänge Cutting edge length	Schaftgröße Shank size	Unterlage Shim	Hebel Lever	Spannschraube Fixation screw	Spannhülse Shim pin	Montagedorn Assembly punch	Schlüssel Key
09	1616	B01-C0931	D02-09120	A03-06170	E01-05405	V10-10000	V01-A0025
12	1616-3225	B01-C1231	D02-12130	A03-08210	E01-07205	V10-20000	V01-A0030
16	2525-3232	B01-C1547	D02-15173	A03-08235	E01-09008	V10-40000	V01-A0030
19	2525-4040	B01-C1847	D02-19210	A03-10270	E01-11011	V10-30000	V01-A0040











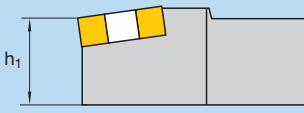

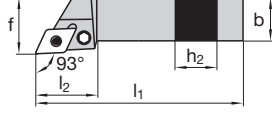
Bestellbeispiel: 1 Stück PCBNR 2525M12
 Order example: 1 piece PCBNR 2525M12

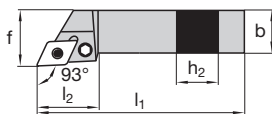
Lieferung ohne Schlüssel
 Delivery without key

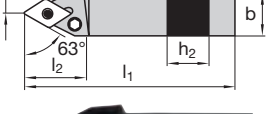
● Verfügbar ab Lager Available from stock
 ○ Auf Anfrage On request

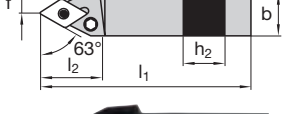
P-Klemmhalter Außenbearbeitung
Tool holders type P, external machining

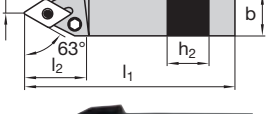

 PDJN-R/L	Bestellbezeichnung Ordering Code	Ident No.	h_1 h_2	b	l_1	l_2	f	Verfüg- barkeit Availa- bility	Passende Wende- platten Suitable inserts	Seite Page	
  	PDJNR 1616H11	6406255	16	16	100	30	20	●	DN.. 11..	44-46	
	PDJNL 1616H11	6406244	16	16	100	30	20	●			
	PDJNR 2020K11	6406256	20	20	125	30	25	●			
	PDJNL 2020K11	6406245	20	20	125	30	25	●			
	PDJNR 2525M11	6406259	25	25	150	30	32	●			
	PDJNL 2525M11	6406248	25	25	150	30	32	●			
	  	PDJNR 2020K15	6406258	20	20	125	34,7	25	●	DN.. 15..	43-46
		PDJNL 2020K15	6406247	20	20	125	34,7	25	●		
		PDJNR 2525M15	6406261	25	25	150	34,7	32	●		
		PDJNL 2525M15	6406250	25	25	150	34,7	32	●		
		PDJNR 3225P15	6406263	32	25	170	34,7	32	●		
		PDJNL 3225P15	6406252	32	25	170	34,7	32	●		
		PDJNR 3232P15	6406264	32	32	170	34,7	40	●		
		PDJNL 3232P15	6406253	32	32	170	34,7	40	●		
  	PDJNR 2020K14	6406257	20	20	125	34,7	25	○	DN.. 14..	46	
	PDJNL 2020K14	6406246	20	20	125	34,7	25	○			
	PDJNR 2525M14	6406260	25	25	150	34,7	32	●			
	PDJNL 2525M14	6406249	25	25	150	34,7	32	●			
	PDJNR 3225P14	6406262	32	25	170	34,7	32	●			
	PDJNL 3225P14	6406251	32	25	170	34,7	32	○			
	PDJNL 4025R14	6406254	40	25	200	34,7	32	○			
  	PDNNR 2525M11	6406270	25	25	150	30	12,5	●	DN.. 11..	44-46	
	PDNNL 2525M11	6406266	25	25	150	30	12,5	○			
	  	PDNNR 2525M15	6406271	25	25	150	36,5	12,5	●	DN.. 15..	43-46
		PDNNL 2525M15	6406267	25	25	150	36,5	12,5	●		
		PDNNR 3225P15	6406272	32	25	170	36,5	12,5	●		
		PDNNL 3225P15	6406268	32	25	170	36,5	12,5	●		
		PDNNR 4025P15	6406273	40	25	170	36,5	12,5	○		
		PDNNL 4025P15	6406269	40	25	170	36,5	12,5	○		

Rechtsausführung wie gezeichnet, Linksausführung spiegelbildlich
 Righthand version as shown, lefthand version mirrorlike

Ersatzteile Spare parts		Bestellbezeichnung Ordering Code					
PD.NR/L							
Schneid- kantenlänge Cutting edge length	Schaftgröße Shank size	Unterlage Shim	Hebel Lever	Spann- schraube Fixation screw	Spannhülse Shim pin	Montagedorn Assembly punch	Schlüssel Key
11	1616-2525	B01-D1131	D02-10120	A03-06170	E01-05405	V10-10000	V01-A0025
14	2020-4025	B01-D1331	D02-15145	A03-08210	E01-07205	V10-20000	V01-A0030
15 ¹⁾	2020-4025	B01-D1448	D02-15145	A03-08210	E01-07205	V10-20000	V01-A0030
15 ²⁾	2020-4025	B01-D1447	D02-15145	A03-08210	E01-07205	V10-20000	V01-A0030
15 ³⁾	2020-4025	B01-D1432	D02-15145	A03-08210	E01-07205	V10-20000	V01-A0030
15 ⁴⁾	2020-4025	B01-D1431	D02-15145	A03-08210	E01-07205	V10-20000	V01-A0030

Für WSP DNMG 1504../ for insert DNMG 1504..

Für WSP DNMG 1506../ for insert DNMG 1506..

¹⁾ s = 4,76 mm, r = 0,4; 0,8 mm

³⁾ s = 6,35 mm, r = 0,4; 0,8 mm

²⁾ s = 4,76 mm, r = 1,2; 1,6 mm





⁴⁾ s = 6,35 mm, r = 1,2; 1,6 mm

Lieferung ohne Schlüssel
 Delivery without key



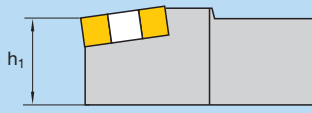
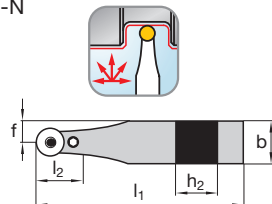

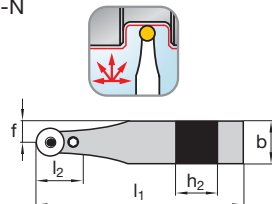
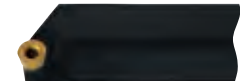
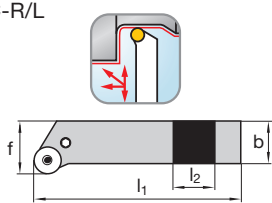
● Verfügbar ab Lager Available from stock
 ○ Auf Anfrage On request

P-Klemmhalter Außenbearbeitung
Tool holders type P, external machining



	Bestellbezeichnung Ordering Code		Ident No.		h ₁ =	b	l ₁	l ₂	f	Verfügbarkeit Availability	Passende Wende- platten Suitable inserts	Seite Page
	h ₂	h ₂	h ₂	h ₂	h ₂	h ₂	h ₂	h ₂	h ₂			
PRDC-N  	PRDCN 2020M10	6406279	20	20	150	22	10	●	RCMX 10..	47		
	PRDCN 2525M10	6406280	25	25	150	22	12,5	●				
	PRDCN 2525M12	6406281	25	25	150	24	12,5	●	RCMX 12..	47		
	PRDCN 3225P12	6406282	32	25	170	24	12,5	●				
	PRDCN 3225P16	6406283	32	25	170	28	12,5	●	RCMX 16..	47		
	PRDCN 3232P20	6406284	32	32	170	32	16	●	RCMX 20..	47		
PRGC-R/L  	PRGCR 2525M12	6406292	25	25	150	32	○	RCMX 12..	47			
	PRGCL 2525M12	6406286	25	25	150	32	●					
	PRGCR 3225P12	6406293	32	25	170	32	●					
	PRGCL 3225P12	6406287	32	25	170	32	○					
	PRGCR 3225P16	6406294	32	25	170	32	●	RCMX 16..	47			
	PRGCL 3225P16	6406288	32	25	170	32	●					
	PRGCR 3232P16	6406295	32	32	170	40	○					
	PRGCL 3232P16	6406289	32	32	170	40	○					
	PRGCR 3232P20	6406296	32	32	170	40	●	RCMX 20..	47			
	PRGCL 3232P20	6406290	32	32	170	40	●					
PRSC-R/L  	PRSCR 2020K10	6406302	20	20	125	25	●	RCMX 10..	47			
	PRSCR 2525M10	6406304	25	25	150	32	●					
	PRSCL 2525M10	6406298	25	25	150	32	●					
	PRSCR 2020K12	6406303	20	20	125	25	●	RCMX 12..	47			
	PRSCL 2525M12	6406299	25	25	150	32	●					
	PRSCR 3225P12	6406306	32	25	170	32	●					
	PRSCL 3225P12	6406301	32	25	170	32	●					
	PRSCR 2525M16	6406305	25	25	150	32	●	RCMX 16..	47			
	PRSCL 2525M16	6406300	25	25	150	32	●					
	PRSCR 3225P16	6406307	32	25	170	32	●					
	PRSCL 3225P16	6406308	32	32	170	40	●	RCMX 20..	47			

Rechtsausführung wie gezeichnet, Linksausführung spiegelbildlich
 Righthand version as shown, lefthand version mirrorlike

Ersatzteile Spare parts		Bestellbezeichnung Ordering Code						
PR.CR/L								
Schneid- kantenlänge Cutting edge length	Schaftgröße Shank size	Unterlage Shim	Hebel Lever	Spann- schraube Fixation screw	Spannhülse Shim pin	Montagedorn Assembly punch	Schlüssel Key	
10	2020-2525	B05-R0831	D05-10118	A03-05140	E01-05405	V10-10000	V01-A0020	
12	2525-3225	B05-R0931	D05-12133	A03-06170	E01-05405	V10-10000	V01-A0025	
16	2525-3225	B05-R1347	D05-17178	A03-06210	E01-07409	V10-20000	V01-A0025	
20	3232	B05-R1747	D05-19189	A03-08235	E01-09008	V10-40000	V01-A0030	
25	4040	B05-R2263	D05-23235	A03-10305	E01-11011	V10-30000	V01-A0040	







Bestellbeispiel: 1 Stück PRDCN 2020M10
 Order example: 1 piece PRDCN 2020M10

Lieferung ohne Schlüssel
 Delivery without key

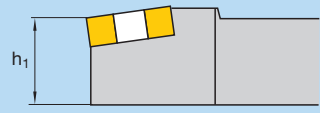
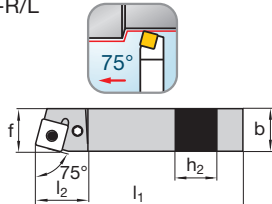
● Verfügbar ab Lager Available from stock
 ○ Auf Anfrage On request

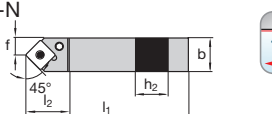
P-Klemmhalter Außenbearbeitung
Tool holders type P, external machining

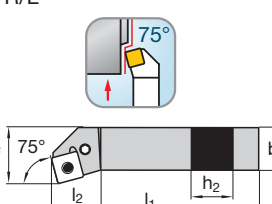

	Bestellbezeichnung Ordering Code Ident No.		$h_1 = h_2$	b	l_1	l_2	f	Verfügbarkeit Availability	Passende Wende- platten Suitable inserts	Seite Page	
	PSBN-R/L	PSBNR 2020K12	6406318	20	20	125	27,5				17
 		PSBNL 2020K12	6406310	20	20	125	27,5	17	●		
		PSBNR 2525M12	6406319	25	25	150	27,5	22	●		
		PSBNL 2525M12	6406311	25	25	150	27,5	22	●		
		PSBNR 3225P12	6406320	32	25	170	32	22	○		
		PSBNL 3225P12	6406312	32	25	170	32	22	○		
		PSBNR 3232P15	6406321	32	32	170	32	27	○	SN.. 15..	51-52
		PSBNL 3232P15	6406313	32	32	170	32	27	○		
		PSBNR 3232P19	6406322	32	32	170	39,2	27	●	SN.. 19..	49-52
		PSBNL 3232P19	6406314	32	32	170	39,2	27	●		
		PSBNR 4040S19	6406323	40	40	250	38,5	35	●		
		PSBNL 4040S19	6406315	40	40	250	38,5	35	●		
		PSBNR 4040S25	6406324	40	40	250	47,5	35	●	SN.. 25..	52
		PSBNL 4040S25	6406316	40	40	250	47,5	35	●		
		PSBNR 5050T25	6406325	50	50	300	49	43	●		
	PSBNL 5050T25	6406317	50	50	300	49	43	●			
 	PSDNN 1616H09	6406326	16	16	100	21	8,3	○	SN.. 09..	50	
	PSDNN 2020K12	6406327	20	20	125	27,6	10,3	●	SN.. 12..	49-52	
	PSDNN 2525M12	6406328	25	25	150	27,6	12,8	●			
	PSDNN 3225P19	6406329	32	25	170	40,4	13	○	SN.. 19..	49-52	
	PSDNN 3232P19	6406330	32	32	170	40,4	12,5	●			
 	PSKNR 1616H09	6406338	16	16	100	18,7	20	○	SN.. 09..	50	
	PSKNL 1616H09	6406331	16	16	100	18,7	20	○			
	PSKNR 2020K12	6406339	20	20	125	22,7	25	○	SN.. 12..	49-52	
	PSKNL 2020K12	6406332	20	20	125	22,7	25	○			
	PSKNR 2525M12	6406340	25	25	150	26	32	○			
	PSKNL 2525M12	6406333	25	25	150	26	32	○			
	PSKNR 3225P12	6406342	32	25	170	26	32	○			
	PSKNL 3225P12	6406335	32	25	170	26	32	○			
	PSKNR 2525M15	6406341	25	25	150	30	32	○	SN.. 15..	51-52	
	PSKNL 2525M15	6406334	25	25	150	30	32	○			
	PSKNR 3232P19	6406343	32	32	170	34	40	●	SN.. 19..	49-52	
	PSKNL 3232P19	6406336	32	32	170	34	40	●			
	PSKNR 4040S19	6406344	40	40	250	38	50	○			
PSKNL 4040S19	6406337	40	40	250	38	50	○				

Rechtsausführung wie gezeichnet, Linksausführung spiegelbildlich
Righthand version as shown, lefthand version mirrorlike

Ersatzteile Spare parts PS.NR/L		Bestellbezeichnung Ordering Code					
Schneid- kantenlänge Cutting edge length	Schaftgröße Shank size	 Unterlage Shim	 Hebel Lever	 Spann- schraube Fixation screw	 Spannhülse Shim pin	 Montagedorn Assembly punch	 Schlüssel Key
09	1616	B01-S0931	D02-09120	A03-05095	E01-05405	V10-10000	V01-A0025
12	2020-3225	B01-S1231	D02-12130	A03-08210	E01-07205	V10-20000	V01-A0030
15	2525-3232	B01-S1547	D02-15173	A03-08235	E01-09008	V10-40000	V01-A0030
19	3232-4040	B01-S1847	D02-19210	A03-10270	E01-11011	V10-30000	V01-A0040
25	4040-5050	B01-S2463	D02-23250	A03-12360	E01-15212	V10-50000	V01-A0050





Bestellbeispiel: 1 Stück PSBNR 2020K12
Order example: 1 piece PSBNR 2020K12

Lieferung ohne Schlüssel
Delivery without key



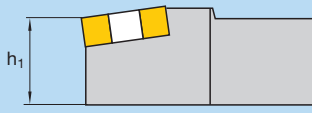

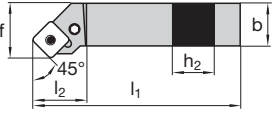

● Verfügbar ab Lager Available from stock
○ Auf Anfrage On request

P-Klemmhalter Außenbearbeitung
Tool holders type P, external machining



 PSSN-R/L   	Bestellbezeichnung Ordering Code		Ident No.	h_1 = h_2	b	l_1	l_2	f	Verfüg- barkeit Availa- bility	Passende Wende- platten Suitable inserts	Seite Page
		PSSNR 1616H09	6406352	16	16	100	21,2	20	●	SN.. 09..	50
	PSSNL 1616H09	6406345	16	16	100	21,2	20	○			
	PSSNR 2020K12	6406353	20	20	125	29,3	25	●	SN.. 12..	49-52	
	PSSNL 2020K12	6406346	20	20	125	29,3	25	●			
	PSSNR 2525M12	6406354	25	25	150	29,3	32	●			
	PSSNL 2525M12	6406347	25	25	150	29,3	32	●			
	PSSNR 3225P12	6406356	32	25	170	32	32	○			
	PSSNL 3225P12	6406349	32	25	170	32	32	○			
	PSSNR 2525M15	6406355	25	25	150	29,3	32	●	SN.. 15..	51-52	
	PSSNL 2525M15	6406348	25	25	150	29,3	32	○			
	PSSNR 3232P19	6406357	32	32	170	40,2	40	○	SN.. 19..	49-52	
	PSSNL 3232P19	6406350	32	32	170	40,2	40	○			
	PSSNR 4040S19	6406358	40	40	250	39,5	50	●			
	PSSNL 4040S19	6406351	40	40	250	39,5	50	○			

Rechtsausführung wie gezeichnet, Linksausführung spiegelbildlich
 Righthand version as shown, lefthand version mirrorlike

Ersatzteile Spare parts		Bestellbezeichnung Ordering Code					
PSSNR/L							
Schneid- kantenlänge Cutting edge length	Schaftgröße Shank size	Unterlage Shim	Hebel Lever	Spann- schraube Fixation screw	Spannhülse Shim pin	Montagedorn Assembly punch	Schlüssel Key
09	1616	B01-S0931	D02-09120	A03-05096	E01-05405	V10-10000	V01-A0025
12	2020-3225	B01-S1231	D02-12130	A03-08210	E01-07205	V10-20000	V01-A0030
15	2525	B01-S1547	D02-15173	A03-08235	E01-09008	V10-40000	V01-A0030
19	3232-4040	B01-S1847	D02-19210	A03-10270	E01-11011	V10-30000	V01-A0040







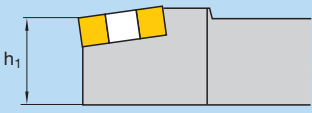

Bestellbeispiel: 1 Stück PSSNR 1616H09
 Order example: 1 piece PSSNR 1616H09

Lieferung ohne Schlüssel
 Delivery without key

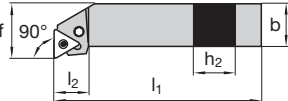

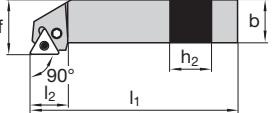



● Verfügbar ab Lager Available from stock
 ○ Auf Anfrage On request

P-Klemmhalter Außenbearbeitung
Tool holders type P, external machining



 Bestellbezeichnung Ordering Code	Ident No.	h_1 = h_2	b	l_1	l_2	f	Verfüg- barkeit Availa- bility	Passende Wende- platten Suitable inserts	Seite Page	
PTFN-R/L   	PTFNR 1616H16	6406364	16	16	100	19,7	20	○	TN.. 16..	54-55
	PTFNL 1616H16	6406359	16	16	100	19,7	20	○		
	PTFNR 2020K16	6406365	20	20	125	20,2	25	●	TN.. 22..	54-55
	PTFNL 2020K16	6406360	20	20	125	20,2	25	○		
	PTFNR 2525M16	6406366	25	25	150	20,2	32	●	TN.. 22..	54-55
	PTFNL 2525M16	6406361	25	25	150	20,2	32	○		
	PTFNR 2525M22	6406367	25	25	150	25,2	32	●	TN.. 22..	54-55
	PTFNL 2525M22	6406362	25	25	150	25,2	32	●		
	PTFNR 3225P22	6406368	32	25	170	25,2	32	○	TN.. 22..	54-55
	PTFNL 3225P22	6406363	32	25	170	25,2	32	○		
PTGN-R/L   	PTGNR 1616H16	6406376	16	16	100	20	20	●	TN.. 16..	54-55
	PTGNL 1616H16	6406369	16	16	100	20	20	○		
	PTGNR 2020K16	6406377	20	20	125	20	25	●	TN.. 22..	54-55
	PTGNL 2020K16	6406370	20	20	125	20	25	○		
	PTGNR 2525M16	6406378	25	25	150	22,2	32	●	TN.. 22..	54-55
	PTGNL 2525M16	6406371	25	25	150	22,2	32	○		
	PTGNR 3225P16	6406380	32	25	170	22,2	32	○	TN.. 22..	54-55
	PTGNL 3225P16	6406373	32	25	170	22,2	32	○		
	PTGNR 2525M22	6406379	25	25	150	25,2	32	●	TN.. 22..	54-55
	PTGNL 2525M22	6406372	25	25	150	25,2	32	●		
PTGNR 3232P22	6406381	32	32	170	28,7	40	○	TN.. 22..	54-55	
PTGNL 3232P22	6406374	32	32	170	28,7	40	○			
PTTN-R/L   	PTTNR 2020K16	6406417	20	20	125	25,9	17	○	TN.. 16..	54-55
	PTTNL 2020K16	6406415	20	20	125	25,9	17	○		
	PTTNR 2525M22	6406418	25	25	150	31,9	22	○	TN.. 22..	54-55
	PTTNL 2525M22	6406416	25	25	150	31,9	22	○		

Rechtsausführung wie gezeichnet, Linksausführung spiegelbildlich
 Righthand version as shown, lefthand version mirrorlike

Ersatzteile Spare parts		Bestellbezeichnung Ordering Code					
PT.NR/L							
Schneid- kantenlänge Cutting edge length	Schaftgröße Shank size	Unterlage Shim	Hebel Lever	Spann- schraube Fixation screw	Spannhülse Shim pin	Montagedorn Assembly punch	Schlüssel Key
16	1616-3225	B01-T1527	D02-09120	A03-06170	E01-05405	V10-10000	V01-A0025
22	2525-3232	B01-T2031	D02-12130	A03-08210	E01-07205	V10-20000	V01-A0030





Bestellbeispiel: 1 Stück PTFNR 1616H16
 Order example: 1 piece PTFNR 1616H16

Lieferung ohne Schlüssel
 Delivery without key



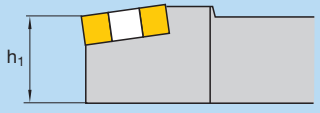

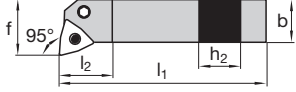

● Verfügbar ab Lager Available from stock
 ○ Auf Anfrage On request

P-Klemmhalter Außenbearbeitung
Tool holders type P, external machining



 Bestellbezeichnung Ordering Code	Ident No.	h_1	h_2	b	l_1	l_2	f	Verfüg- barkeit Availa- bility	Passende Wende- platten Suitable inserts	Seite Page
		=								
PWLN-R/L   	PWLN R 1616H06	6406425	16	16	100	20	20	●	WN.. 06..	59-61
	PWLN L 1616H06	6406419	16	16	100	20	20	○		
	PWLN R 2020K06	6406426	20	20	125	25	25	●		
	PWLN L 2020K06	6406420	20	20	125	25	25	●		
	PWLN R 2525M06	6406428	25	25	150	25	32	○		
	PWLN L 2525M06	6406422	25	25	150	25	32	○		
	PWLN R 2020K08	6406427	20	20	125	25	25	●	WN.. 08..	59-62
	PWLN L 2020K08	6406421	20	20	125	25	25	●		
	PWLN R 2525M08	6406429	25	25	150	25	32	●		
	PWLN L 2525M08	6406423	25	25	150	25	32	●		
	PWLN R 3225P08	6406430	32	25	170	25	32	●		
	PWLN L 3225P08	6406424	32	25	170	25	32	●		

Rechtsausführung wie gezeichnet, Linksausführung spiegelbildlich
 Righthand version as shown, lefthand version mirrorlike

Ersatzteile Spare parts PWLN R/L		Bestellbezeichnung Ordering Code					
Schneid- kantenlänge Cutting edge length	Schaftgröße Shank size	 Unterlage Shim	 Hebel Lever	 Spann- schraube Fixation screw	 Spannhülse Shim pin	 Montagedorn Assembly punch	 Schlüssel Key
06	1616-2525	B01-W0627	D02-09120	A03-06170	E01-05807	V10-10000	V01-A0025
08	2020-3225	B01-W0831	D02-12130	A03-08210	E01-07205	V10-20000	V01-A0030





Bestellbeispiel: 1 Stück PWLN R 1616H06
 Order example: 1 piece PWLN R 1616H06

Lieferung ohne Schlüssel
 Delivery without key

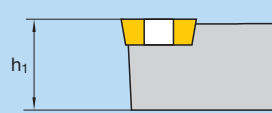
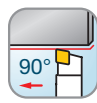
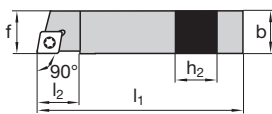

● Verfügbar ab Lager Available from stock
 ○ Auf Anfrage On request

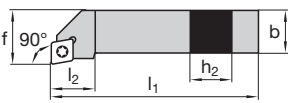
S-Klemmhalter Außenbearbeitung
Tool holders type S, external machining



	Bestellbezeichnung Ordering Code		h ₁ = h ₂	b	l ₁	l ₂	f	Verfügbarkeit Availability	Passende Wendeplatten Suitable inserts	Seite Page		
	Ident No.											
SCAC-R/L   	SCACR 0808D06	6406571	8	8	60	9	8	○	CC.. 06..	34-35		
	SCACL 0808D06	6406562	8	8	60	9	8	○				
	SCACR 0808K06	6406572	8	8	125	9	8	○				
	SCACL 0808K06	6406563	8	8	125	9	8	○				
	SCACR 1010E06	6406573	10	10	70	9	10	○				
	SCACL 1010E06	6406564	10	10	70	9	10	○				
	SCACR 1010M06	6406574	10	10	150	9	10	○				
	SCACL 1010M06	6406565	10	10	150	9	10	○				
	SCACR 1212F09	6406575	12	12	80	13	12	○			CC.. 09..	34-35
	SCACL 1212F09	6406566	12	12	80	13	12	○				
	SCACR 1212M09	6406576	12	12	150	13	12	○				
	SCACL 1212M09	6406567	12	12	150	13	12	○				
	SCACR 1414M09	6406577	14	14	150	13	14	○				
	SCACL 1414M09	6406568	14	14	150	13	14	○				
	SCACR 1616H09	6406578	16	16	100	13	16	○			CC.. 12..	34-35
	SCACL 1616H09	6406569	16	16	100	13	16	○				
	SCACR 2020K12	6406579	20	20	125	17	20	○				
	SCACL 2020K12	6406570	20	20	125	17	20	○				
SCDC-L	SCDCL 0808K06	6406580	8	8	125	13	4	○	CC.. 06..	34-35		
	SCDCL 1010M06	6406581	10	10	150	13	5	○	CC.. 09..	34-35		
	SCDCL 1212M09	6406582	12	12	150	18	6	○				
	SCDCL 1414M09	6406583	14	14	150	18	7	○				
SCFC-R/L   	SCFCR 0808D06	6406589	8	8	60	10	8	○	CC.. 06..	34-35		
	SCFCL 0808D06	6406584	8	8	60	10	8	○				
	SCFCR 1010E06	6406590	10	10	70	10	10	○				
	SCFCL 1010E06	6406585	10	10	70	10	10	○				
		SCFCR 1212F09	6406591	12	12	80	13	12	○	CC.. 09..	34-35	
		SCFCL 1212F09	6406586	12	12	80	13	12	○			
		SCFCR 1616H09	6406592	16	16	100	13	16	●			
		SCFCL 1616H09	6406587	16	16	100	13	16	○			
		SCFCR 2020K12	6406593	20	20	125	17	20	●	CC.. 12..	34-35	
		SCFCL 2020K12	6406588	20	20	125	17	20	○			

Rechtsausführung wie gezeichnet, Linksausführung spiegelbildlich
 Righthand version as shown, lefthand version mirrorlike

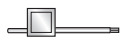
Ersatzteile Spare parts SC.CR/L		Bestellbezeichnung Ordering Code			
Schneidkantenlänge Cutting edge length	Schaftgröße Shank size	 Unterlage Shim	 Gewindehülse Shim screw	 Klemmschraube Fixation screw	 Schlüssel Key
06	0808–1010	–	–	A02-25059	V02-T0800
09	1212–1414	–	–	A02-35082	V02-T1500
09	1616–2020	B09-C0923	E09-F5035	A02-35096	V05-T1534
12	1616–2020	B09-C1231	E09-F6045	A02-45102	V05-T1534







Bestellbeispiel: 1 Stück SCFCR 0808D06
 Order example: 1 piece SCFCR 0808D06

Lieferung ohne Schlüssel
 Delivery without key

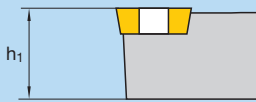
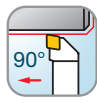
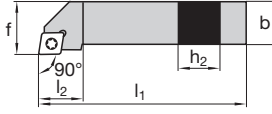
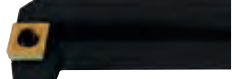
● Verfügbar ab Lager Available from stock
 ○ Auf Anfrage On request

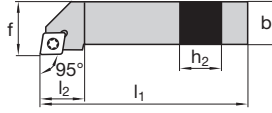
S-Klemmhalter Außenbearbeitung
Tool holders type S, external machining

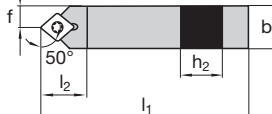

	Bestellbezeichnung Ordering Code		h ₁ = h ₂	b	l ₁	l ₂	f	Verfügbarkeit Availability	Passende Wende- platten Suitable inserts	Seite Page
	Ident No.									
SCGC-R/L   	SCGCR 2020K12	6406595	20	20	125	17	25	○	CC.. 12..	34-35
	SCGCL 2020K12	6406594	20	20	125	17	25	○		
SCLC-R/L   	SCLCR 0808D06	6406614	8	8	60	9	8	●	CC.. 06..	34-35
	SCLCL 0808D06	6406605	8	8	60	9	8	●		
	SCLCR 1010E06	6406615	10	10	70	9	12	●		
	SCLCR 1212F09	6406616	12	12	80	15	16	●	CC.. 09..	34-35
	SCLCL 1212F09	6406607	12	12	80	15	16	●		
	SCLCR 1616H09	6406617	16	16	100	17	20	●		
	SCLCL 1616H09	6406608	16	16	100	17	20	●		
	SCLCR 2020K09	6406619	20	20	125	17	25	●		
	SCLCL 2020K09	6406610	20	20	125	17	25	●		
	SCLCR 1616H12	6406618	16	16	100	20	20	●		
	SCLCL 1616H12	6406609	16	16	100	20	20	●		
	SCLCR 2020K12	6406620	20	20	125	20	25	●		
	SCLCL 2020K12	6406611	20	20	125	20	25	●		
	SCLCR 2525M12	6406621	25	25	150	20	32	●		
SCLCL 2525M12	6406612	25	25	150	20	32	●			
SCLCR 3225P12	6406622	32	25	170	20	32	●			
SCLCL 3225P12	6406613	32	25	170	20	32	●			
SCMC-N   	SCMCN 1616H12	6406623	16	16	100	25	8	○	CC.. 12..	34-35
	SCMCN 2020K12	6406624	20	20	125	25	10	●		
	SCMCN 2525M12	6406625	25	25	150	25	12,5	●		
	SCMCN 3225P12	6406626	32	25	170	25	12,5	○		

Rechtsausführung wie gezeichnet, Linksausführung spiegelbildlich
 Righthand version as shown, lefthand version mirrorlike

Ersatzteile Spare parts SC.C.R/L		Bestellbezeichnung Ordering Code			
Schneid- kantenlänge Cutting edge length	Schaftgröße Shank size	 Unterlage Shim	 Gewindehülse Shim screw	 Klemm- schraube Fixation screw	 Schlüssel Key
06	0808 – 1010	–	–	A02-25059	V02-T0800
09	1212	–	–	A02-35082	V02-T1500
09	1616 – 2020	B09-C0923	E09-F5035	A02-35096	V05-T1534
12	1616 – 3225	B09-C1231	E09-F6045	A02-45102	V05-T1534







Bestellbeispiel: 1 Stück SCLCR 0808D06
 Order example: 1 piece SCLCR 0808D06

Lieferung ohne Schlüssel
 Delivery without key

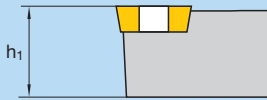

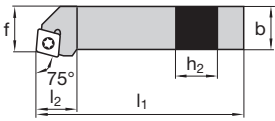
● Verfügbar ab Lager Available from stock
 ○ Auf Anfrage On request

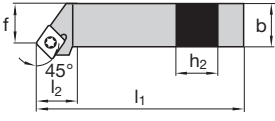
S-Klemmhalter Außenbearbeitung
Tool holders type S, external machining



	Bestellbezeichnung Ordering Code		h ₁ = h ₂	b	l ₁	l ₂	f	Verfügbarkeit Availability	Passende Wende- platten Suitable inserts	Seite Page							
	Ident No.																
<p>SCRCR-R/L</p>   	SCRCR 0808D06	6406647	8	8	60	10	9	○	CC.. 06..	34-35							
	SCRCR 0808D06	6406638	8	8	60	10	9	○									
	SCRCR 1010E06	6406648	10	10	70	10	11	○									
	SCRCR 1010E06	6406639	10	10	70	10	11	○									
	<p>SCRCR 1212F09</p> <p>SCRCR 1616H09</p> <p>SCRCR 2020K09</p> <p>SCRCR 1616H12</p> <p>SCRCR 2020K12</p> <p>SCRCR 2525M12</p> <p>SCRCR 3225P12</p>	6406649	6406640	6406650	6406641	6406652	6406643	6406651	6406642	6406653	6406644	6406654	6406645	6406655	6406646	CC.. 09..	34-35
		12	12	80	16	13	○										
		12	12	80	16	13	○										
		16	16	100	17	17	○										
		16	16	100	17	17	○										
		20	20	125	17	22	○										
		20	20	125	17	22	○										
		16	16	100	20	17	○										
		16	16	100	20	17	○										
		20	20	125	20	22	○										
	20	20	125	20	22	○											
	25	25	150	20	27	○											
	25	25	150	20	27	○											
	32	25	170	20	27	○											
32	25	170	20	27	○												
<p>SCSC-R/L</p>   	SCSCR 1616H12	6406660	16	16	100	20	20	○	CC.. 12..	34-35							
	SCSCL 1616H12	6406656	16	16	100	20	20	○									
	SCSCR 2020K12	6406661	20	20	125	20	25	●									
	SCSCL 2020K12	6406657	20	20	125	20	25	○									
	SCSCR 2525M12	6406662	25	25	150	20	32	●									
	SCSCL 2525M12	6406658	25	25	150	20	32	○									
	SCSCR 3225P12	6406663	32	25	170	20	32	○									
	SCSCL 3225P12	6406659	32	25	170	20	32	○									

Rechtsausführung wie gezeichnet, Linksausführung spiegelbildlich
 Righthand version as shown, lefthand version mirrorlike

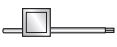
Ersatzteile Spare parts SC.CR/L		Bestellbezeichnung Ordering Code				
Schneid- kantenlänge Cutting edge length	Schaftgröße Shank size	 Unterlage Shim	 Gewindehülse Shim screw	 Klemm- schraube Fixation screw	 Schlüssel Key	
06	0808 – 1010	–	–	A02-25059	V02-T0800	
09	1212	–	–	A02-35082	V02-T1500	
09	1616 – 2020	B09-C0923	E09-F5035	A02-35096	V05-T1534	
12	1616 – 3225	B09-C1231	E09-F6045	A02-45102	V05-T1534	







Bestellbeispiel: 1 Stück SCRCR 0808D06
 Order example: 1 piece SCRCR 0808D06

Lieferung ohne Schlüssel
 Delivery without key

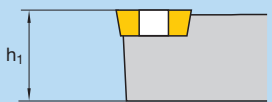
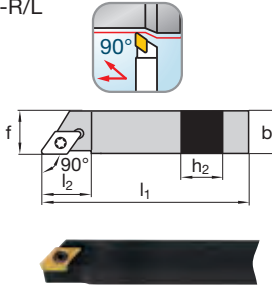
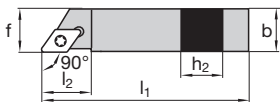
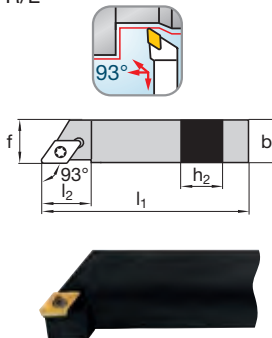
● Verfügbar ab Lager Available from stock
 ○ Auf Anfrage On request

S-Klemmhalter Außenbearbeitung
Tool holders type S, external machining



			h ₁ = h ₂	b	l ₁	l ₂	f	Verfüg- barkeit Availa- bility	Passende Wende- platten Suitable inserts	Seite Page		
	Bestellbezeichnung Ordering Code	Ident No.										
SDAC-R/L   	SDACR 0808K07	6406673	8	8	125	14	8	●	DC.. 07..	41-43		
	SDACL 0808K07	6406668	8	8	125	14	8	●				
	SDACR 1010M07	6406674	10	10	150	14	10	●				
	SDACL 1010M07	6406669	10	10	150	14	10	○				
	SDACR 1010X07-D	6424956	10	10	115	15	10	○				
	SDACL 1010X07-D	6424954	10	10	115	15	10	○				
	SDACR 1212M07	6406675	12	12	150	14	12	●				
	SDACL 1212M07	6406670	12	12	150	14	12	○				
	SDACR 1212X07-D	6424957	12	12	130	15	12	●				
	SDACL 1212X07-D	6424955	12	12	130	15	12	●				
	SDACR 1212M11	6406676	12	12	150	21	12	●			DC.. 11..	41-43
	SDACL 1212M11	6406671	12	12	150	21	12	●				
SDACR 1414M11	6406677	14	14	150	21	14	○					
SDACL 1414M11	6406672	14	14	150	21	14	●					
SDHC-R/L   	SDHCR 1010E07	6406683	10	10	70	5,5	12	○	DC.. 07..	41-43		
	SDHCL 1010E07	6406678	10	10	70	5,5	12	○				
	SDHCR 1212F07	6406684	12	12	80	12	16	●				
	SDHCL 1212F07	6406679	12	12	80	12	16	○				
	SDHCR 1616H11	6406685	16	16	100	10,4	20	●	DC.. 11..	41-43		
	SDHCL 1616H11	6406680	16	16	100	10,4	20	●				
	SDHCR 2020K11	6406686	20	20	125	14	25	●				
	SDHCL 2020K11	6406681	20	20	125	14	25	●				
	SDHCR 2525M11	6406687	25	25	150	20	32	●				
	SDHCL 2525M11	6406682	25	25	150	20	32	●				
SDJC-R/L   	SDJCR 0808D07	6406717	8	8	60	13	10	○	DC.. 07..	41-43		
	SDJCL 0808D07	6406708	8	8	60	13	10	○				
	SDJCR 1010E07	6406718	10	10	70	13	12	●				
	SDJCL 1010E07	6406709	10	10	70	13	12	●				
	SDJCR 1010X07-D	6424962	10	10	115	15	10	●				
	SDJCL 1010X07-D	6424958	10	10	115	15	10	○				
	SDJCR 1212F07	6406719	12	12	80	14,5	16	●				
	SDJCL 1212F07	6406710	12	12	80	14,5	16	●				
	SDJCR 1212X07-D	6424963	12	12	130	15	12	○				
	SDJCL 1212X07-D	6424959	12	12	130	15	12	●				
	SDJCR 1212F11	6406720	12	12	80	22	16	●			DC.. 11..	41-43
	SDJCL 1212F11	6406711	12	12	80	22	16	●				
	SDJCR 1212X11-D	6424964	12	12	130	15	12	●				
	SDJCL 1212X11-D	6424960	12	12	130	15	12	○				
	SDJCR 1616H11	6406721	16	16	100	20	20	●				
	SDJCL 1616H11	6406712	16	16	100	20	20	●				
	SDJCR 1616X11-D	6424965	16	16	130	20	16	●				
	SDJCL 1616X11-D	6424961	16	16	130	20	16	●				
	SDJCR 2020K11	6406722	20	20	125	20,5	25	●				
	SDJCL 2020K11	6406713	20	20	125	20,5	25	●				
	SDJCR 2525M11	6406723	25	25	150	21,5	32	●				
	SDJCL 2525M11	6406714	25	25	150	21,5	32	●				
	SDJCR 3225P11	6406725	32	25	150	21,25	32	●				
	SDJCL 3225P11	6406716	32	25	150	21,25	32	●				
	SDJCR 2525M15	6406724	25	25	150	26	32	●	DC.. 15..			
	SDJCL 2525M15	6406715	25	25	150	26	32	●				

Rechtsausführung wie gezeichnet, Linksausführung spiegelbildlich
 Righthand version as shown, lefthand version mirrorlike



Bestellbeispiel: 1 Stück SDACR 0808K07
 Order example: 1 piece SDACR 0808K07

Lieferung ohne Schlüssel
 Delivery without key

● Verfügbar ab Lager Available from stock
 ○ Auf Anfrage On request

S-Klemmhalter Außenbearbeitung
Tool holders type S, external machining

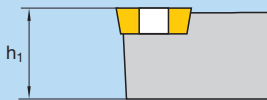
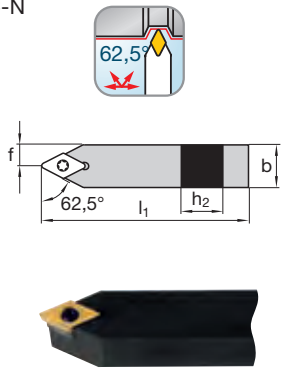
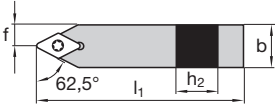

			$h_1 = h_2$	b	l ₁	f	Verfügbarkeit Availability	Passende Wende- platten Suitable inserts	Seite Page
	Bestellbezeichnung Ordering Code	Ident No.							
<p>SDNC-N</p>   	SDNCN 0808D07	6406734	8	8	60	4	○	DC.. 07..	41-43
	SDNCN 0808K07	6406735	8	8	125	4	○		
	SDNCN 1010E07	6406736	10	10	70	5	●		
	SDNCN 1010M07	6406737	10	10	150	5	●		
	SDNCN 1212F07	6406738	12	12	80	6	●		
	SDNCN 1212M07	6406740	12	12	150	6	●		
	SDNCN 1212F11	6406739	12	12	80	6	○	DC.. 11..	41-43
	SDNCN 1212M11	6406741	12	12	150	6	○		
	SDNCN 1414M11	6406742	14	14	150	7	○		
	SDNCN 1616H11	6406743	16	16	100	8	●		
	SDNCN 2020K11	6406744	20	20	125	10	●		
	SDNCN 2525M11	6406745	25	25	150	12,5	●		

Ersatzteile Spare parts SD.CR/L		Bestellbezeichnung Ordering Code				
Schneid- kantenlänge Cutting edge length	Schaftgröße Shank size	 Unterlage Shim	 Gewindehülse Shim screw	 Klemm- schraube Fixation screw	 Schlüssel Key	
07	0808 – 1212	–	–	A02-25059	V02-T0800	
11	1212 – 1414	–	–	A02-35082	V02-T1500	
11	1616 – 2525	B09-D1131	E09-F5035	A02-35096	V05-T1534	
15	2525	B02-D1431	E02-60045	A02-45102	V05-T1534	



Bestellbeispiel: 1 Stück SDNCN 0808D07
 Order example: 1 piece SDNCN 0808D07



Lieferung ohne Schlüssel
 Delivery without key

- Verfügbar ab Lager Available from stock
- Auf Anfrage On request

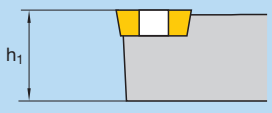
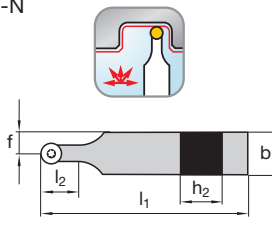
S-Klemmhalter Außenbearbeitung Tool holders type S, external machining

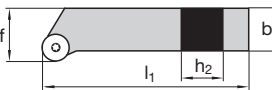

 SRDC-N  	Bestellbezeichnung Ordering Code		Ident No.	h_1 = h_2	b	l_1	l_2	f	Verfügbarkeit Availability	Passende Wendeplatten Suitable inserts	Seite Page
		SRDCN 1212F06	6406989	12	12	80	12,4	6	●	RCGT 06..	47
	SRDCN 1616H06	6406990	16	16	100	12,4	8	●	RCMT 06..		
	SRDCN 2020K06	6406994	20	20	125	12,4	10	●			
	SRDCN 2525M06	6406997	25	25	150	12,4	12,5	●			
	SRDCN 1616H08	6406991	16	16	100	16,4	8	○	RCGT 08..	47	
	SRDCN 2020K08	6406995	20	20	125	16,4	10	●			
	SRDCN 2525M08	6406998	25	25	150	16,4	12,5	●			
	SRDCN 1616H10	6406992	16	16	100	20,3	8	●	RCGT 10..	47	
	SRDCN 2020K10	6406996	20	20	125	20,3	10	●			
	SRDCN 2525M10	6406999	25	25	150	20,3	12,5	●			

 SRGC-R/L  	Bestellbezeichnung Ordering Code		Ident No.	h_1 = h_2	b	l_1	l_2	f	Verfügbarkeit Availability	Passende Wendeplatten Suitable inserts	Seite Page
		SRGCR 1212F06	6407010	12	12	80	10	16	○	RCGT 06..	47
	SRGCL 1212F06	6407000	12	12	80	10	16	○	RCMT 06..		
	SRGCR 1616H06	6407011	16	16	100	10	20	○	RCMT 06..		
	SRGCL 1616H06	6407001	16	16	100	10	20	○	RCMT 06..		
	SRGCR 2020K06	6407014	20	20	125	11,5	25	○			
	SRGCL 2020K06	6407004	20	20	125	11,5	25	○			
	SRGCR 2525M06	6407017	25	25	150	15	32	○			
	SRGCL 2525M06	6407007	25	25	150	15	32	○			
	SRGCR 1616H08	6407012	16	16	100	11	20	○	RCGT 08..	47	
	SRGCL 1616H08	6407002	16	16	100	11	20	○			
	SRGCR 2020K08	6407015	20	20	125	12	25	○			
	SRGCL 2020K08	6407005	20	20	125	12	25	○			
	SRGCR 2525M08	6407018	25	25	150	16,4	32	○			
	SRGCL 2525M08	6407008	25	25	150	16,4	32	○			
	SRGCR 1616H10	6407013	16	16	100	12	20	○	RCGT 10..	47	
	SRGCL 1616H10	6407003	16	16	100	12	20	○			
	SRGCR 2020K10	6407016	20	20	125	13,5	25	○			
	SRGCL 2020K10	6407006	20	20	125	13,5	25	○			
	SRGCR 2525M10	6407019	25	25	150	17	32	○			
	SRGCL 2525M10	6407009	25	25	150	17	32	○			

Rechtsausführung wie gezeichnet, Linksausführung spiegelbildlich
Righthand version as shown, lefthand version mirrorlike

Ersatzteile Spare parts		Bestellbezeichnung Ordering Code				
SR.CN/R/L						
Schneidkantenlänge Cutting edge length	Schaftgröße Shank size	Unterlage Shim	Gewindehülse Shim screw	Klemmschraube Fixation screw	Schlüssel Key	
06	1212-2525	-	-	A02-25059	V02-T0800	
08	1616-2525	-	-	A13-30073	V02-T1500	
10	1616-2525	B09-R1025	E09-F5035	A13-35110	V05-T1534	

Bestellbeispiel: 1 Stück SRDCN 1212F06
Order example: 1 piece SRDCN 1212F06

Lieferung ohne Schlüssel
Delivery without key

● Verfügbar ab Lager Available from stock
○ Auf Anfrage On request

S-Klemmhalter Außenbearbeitung

Tool holders type S, external machining



	Bestellbezeichnung		h ₁ = h ₂	b	l ₁	l ₂	f	Verfügbarkeit	Passende Wende- platten Suitable inserts	Seite	
	Ordering Code	Ident No.									Availability
SSBC-R/L 	SSBCR 1616H09	6407024	16	16	100	20	13	○	SC.. 09..	48-49	
	SSBCL 1616H09	6407020	16	16	100	20	13	○			
	SSBCR 2020K09	6407025	20	20	125	20	17	○			
	SSBCL 2020K09	6407021	20	20	125	20	17	○			
	SSBCR 2020K12	6407026	20	20	125	20	17	○	SC.. 12..	48-49	
	SSBCL 2020K12	6407022	20	20	125	20	17	○			
	SSBCR 2525M12	6407027	25	25	150	20	22	○			
	SSBCL 2525M12	6407023	25	25	150	20	22	○			
	SSDC-N 	SSDCN 1212F09	6407028	12	12	80	16	6	●	SC.. 09..	48-49
		SSDCN 1616H09	6407029	16	16	100	20	8	●		
SSDCN 2020K09		6407030	20	20	125	20	10	●			
SSDCN 1616H12		6407031	16	16	100	25	8	○	SC.. 12..	48-49	
SSDCN 2020K12		6407032	20	20	125	25	10	●			
SSDCN 2525M12		6407033	25	25	150	25	12,5	●			
SSKC-R/L 		SSKCR 1616H09	6407039	16	16	100	22	20	●	SC.. 09..	48-49
	SSKCL 1616H09	6407034	16	16	100	22	20	○			
	SSKCR 2020K09	6407041	20	20	125	22	25	○			
	SSKCL 2020K09	6407036	20	20	125	22	25	○			
	SSKCR 1616H12	6407040	16	16	100	23	20	○	SC.. 12..	48-49	
	SSKCL 1616H12	6407035	16	16	100	23	20	○			
	SSKCR 2020K12	6407042	20	20	125	23	25	●			
	SSKCL 2020K12	6407037	20	20	125	23	25	○			
	SSKCR 2525M12	6407043	25	25	150	23	32	●			
	SSKCL 2525M12	6407038	25	25	150	23	32	●			

Rechtsausführung wie gezeichnet, Linksausführung spiegelbildlich
 Righthand version as shown, lefthand version mirrorlike

Ersatzteile Spare parts		Bestellbezeichnung Ordering Code				
SS.CN/R/L						
Schneid- kantenlänge Cutting edge length	Schaftgröße Shank size	Unterlage Shim	Gewindehülse Shim screw	Klemm- schraube Fixation screw	Schlüssel Key	
09	1212	-	-	A02-35082	V02-T1500	
09	1616-2020	B09-S0923	E09-F5035	A02-35096	V05-T1534	
12	1616-2525	B09-S1231	E09-F6045	A02-45102	V05-T1534	





Bestellbeispiel: 1 Stück SSBCR 1616H09
 Order example: 1 piece SSBCR 1616H09

Lieferung ohne Schlüssel
 Delivery without key

● Verfügbar ab Lager Available from stock
 ○ Auf Anfrage On request

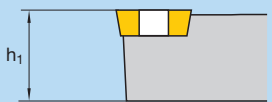
S-Klemmhalter Außenbearbeitung
Tool holders type S, external machining

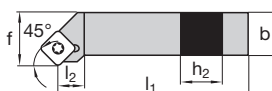

	Bestellbezeichnung		h ₁ = h ₂	b	l ₁	l ₂	f	Verfüg- barkeit Availa- bility	Passende Wende- platten Suitable inserts	Seite Page
	Ordering Code	Ident No.								
<p>SSSC-R/L</p>   	SSSCR 1212F09	6407051	12	12	80	18	16	●	SC.. 09..	48-49
	SSSCL 1212F09	6407044	12	12	80	18	16	○		
	SSSCR 1616H09	6407052	16	16	100	20	20	●		
	SSSCL 1616H09	6407045	16	16	100	20	20	○		
	SSSCR 2020K09	6407054	20	20	125	20	25	●		
	SSSCL 2020K09	6407047	20	20	125	20	25	○	SC.. 12..	48-49
	SSSCR 1616H12	6407053	16	16	100	25	20	●		
	SSSCL 1616H12	6407046	16	16	100	25	20	○		
	SSSCR 2020K12	6407055	20	20	125	25	25	●		
	SSSCL 2020K12	6407048	20	20	125	25	25	○		
	SSSCR 2525M12	6407056	25	25	150	25	32	●		
	SSSCL 2525M12	6407049	25	25	150	25	32	○		
	SSSCR 3225P12	6407057	32	25	170	25	32	○		
	SSSCL 3225P12	6407050	32	25	170	25	32	○		

Rechtsausführung wie gezeichnet, Linksausführung spiegelbildlich
 Righthand version as shown, lefthand version mirrorlike

Ersatzteile Spare parts		Bestellbezeichnung Ordering Code			
SSSCR/L					
Schneid- kantenlänge Cutting edge length	Schaftgröße Shank size	Unterlage Shim	Gewindehülse Shim screw	Klemm- schraube Fixation screw	Schlüssel Key
09	1212	–	–	A02-35082	V02-T1500
09	1616–2020	B09-S0923	E09-F5035	A02-35096	V05-T1534
12	1616–3225	B09-S1231	E09-F6045	A02-45102	V05-T1534

Bestellbeispiel: 1 Stück SSSCR 1212F09
 Order example: 1 piece SSSCR 1212F09

Lieferung ohne Schlüssel
 Delivery without key

● Verfügbar ab Lager Available from stock
 ○ Auf Anfrage On request

S-Klemmhalter Außenbearbeitung

Tool holders type S, external machining

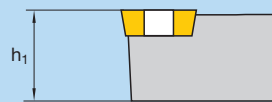
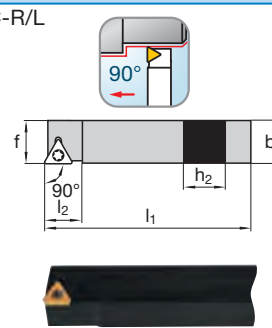
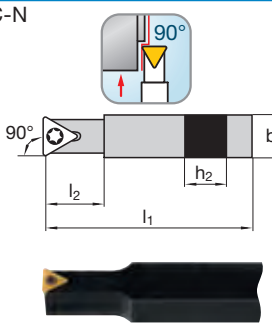
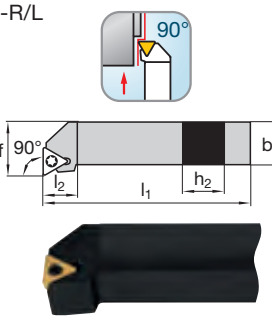

	Bestellbezeichnung		h ₁ = h ₂	b	l ₁	l ₂	f	Verfügbarkeit Availability	Passende Wende- platten Suitable inserts	Seite Page
	Ordering Code	Ident No.								
STAC-R/L 	STACR 1212K11	6407061	12	12	125	15	12	●	TC.. 11..	53-55
	STACL 1212K11	6407058	12	12	125	15	12	○		
	STACR 1414K11	6407062	14	14	125	15	14	○		
	STACL 1414K11	6407059	14	14	125	15	14	○		
	STACR 1616K11	6407063	16	16	125	15	16	○		
	STACL 1616K11	6407060	16	16	125	15	16	○		
STCC-N 	STCCN 1010K11	6407074	10	10	125	15	-	○	TC.. 11..	53-55
	STCCN 1212K11	6407075	12	12	125	15	-	○		
	STCCN 1414K11	6407076	14	14	125	21	-	○		
	STCCN 1616K11	6407077	16	16	125	24	-	●		
STFC-R/L 	STFCR 1212F11	6407104	12	12	80	15	16	●	TC.. 11..	53-55
	STFCL 1212F11	6407100	12	12	80	15	16	○		
	STFCR 1616H16	6407105	16	16	100	20	20	○	TC.. 16..	53-55
	STFCL 1616H16	6407101	16	16	100	20	20	○		
	STFCR 2020K16	6407106	20	20	125	20	25	○		
	STFCL 2020K16	6407102	20	20	125	20	25	○		
	STFCR 2525M16	6407107	25	25	150	20	32	●		
	STFCL 2525M16	6407103	25	25	150	20	32	○		

Rechtsausführung wie gezeichnet, Linksausführung spiegelbildlich
 Righthand version as shown, lefthand version mirrorlike

Ersatzteile Spare parts		Bestellbezeichnung Ordering Code			
ST.CR/L					
Schneid- kantenlänge Cutting edge length	Schaftgröße Shank size	 Unterlage Shim	 Gewindehülse Shim screw	 Klemm- schraube Fixation screw	 Schlüssel Key
11	1010 – 1616	-	-	A02-25059	V02-T0800
16	1616 – 2525	B09-T1631	E09-F5035	A02-35096	V05-T1534





Bestellbeispiel: 1 Stück STACR 1212K11
 Order example: 1 piece STACR 1212 K11

Lieferung ohne Schlüssel
 Delivery without key

● Verfügbar ab Lager Available from stock
 ○ Auf Anfrage On request

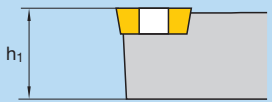
S-Klemmhalter Außenbearbeitung
Tool holders type S, external machining

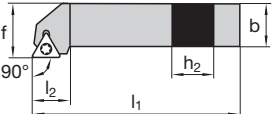

	Bestellbezeichnung		h ₁ = h ₂	b	l ₁	l ₂	f	Verfüg- barkeit Availa- bility	Passende Wende- platten Suitable inserts	Seite Page
	Ordering Code	Ident No.								
STGC-R/L   	STGCR 1212F11	6407112	12	12	80	15	16	●	TC.. 11..	53-55
	STGCL 1212F11	6407108	12	12	80	15	16	○		
	STGCR 1616H16	6407113	16	16	100	22	20	●	TC.. 16..	53-55
	STGCL 1616H16	6407109	16	16	100	22	20	●		
	STGCR 2020K16	6407114	20	20	125	22	25	●		
	STGCL 2020K16	6407110	20	20	125	22	25	●		
	STGCR 2525M16	6407115	25	25	150	22	32	●		
	STGCL 2525M16	6407111	25	25	150	22	32	○		

Rechtsausführung wie gezeichnet, Linksausführung spiegelbildlich
 Righthand version as shown, lefthand version mirrorlike

Ersatzteile Spare parts		Bestellbezeichnung Ordering Code			
STGCR/L					
Schneid- kantenlänge Cutting edge length	Schaftgröße Shank size	Unterlage Shim	Gewindehülse Shim screw	Klemm- schraube Fixation screw	Schlüssel Key
11	1212	-	-	A02-25059	V02-T0800
16	1616-2525	B09-T1631	E09-F5035	A02-35096	V05-T1534

Bestellbeispiel: 1 Stück STGCR 1212F11
 Order example: 1 piece STGCR 1212 F11

Lieferung ohne Schlüssel
 Delivery without key

● Verfügbar ab Lager Available from stock
 ○ Auf Anfrage On request

S-Klemmhalter Außenbearbeitung

Tool holders type S, external machining



	Bestellbezeichnung		h ₁ = h ₂	b	l ₁	l ₂	f	Verfügbarkeit Availability	Passende Wende- platten Suitable inserts	Seite Page
	Ordering Code	Ident No.								
	SVHBR 2020K16	6407118	20	20	125	17	25	●	VB.. 16..	56
	SVHBL 2020K16	6407116	20	20	125	17	25	●		
	SVHBR 2525M16	6407119	25	25	150	26	32	●		
	SVHBL 2525M16	6407117	25	25	150	26	32	●		
	SVHCR 1212F11	6407130	12	12	80	11,4	16	●	VC.. 11..	56-57
	SVHCL 1212F11	6407120	12	12	80	11,4	16	●		
	SVHCR 1616H11	6407131	16	16	100	11,4	20	●		
	SVHCL 1616H11	6407121	16	16	100	11,4	20	●		
	SVHCR 2020K11	6407132	20	20	125	14,6	25	●		
	SVHCL 2020K11	6407122	20	20	125	14,6	25	●		
	SVHCR 2525M11	6407135	25	25	150	20,9	32	●		
	SVHCL 2525M11	6407125	25	25	150	20,9	32	●		
	SVHCR 2020K16	6407133	20	20	125	13,2	25	●	VC.. 16..	57-58
	SVHCL 2020K16	6407123	20	20	125	13,2	25	●		
	SVHCR 2525M16	6407136	25	25	150	19,6	32	●		
	SVHCL 2525M16	6407126	25	25	150	19,6	32	●		
	SVHCR 3225P16	6407138	32	25	170	19,6	32	●		
	SVHCL 3225P16	6407128	32	25	170	19,6	32	○		
	SVHCR 2020K22	6407134	20	20	125	13,2	25	○	VC.. 22..	57
	SVHCL 2020K22	6407124	20	20	125	13,2	25	●		
SVHCR 2525M22	6407137	25	25	150	19,6	32	●			
SVHCL 2525M22	6407127	25	25	150	19,6	32	○			
SVHCR 3225P22	6407139	32	25	170	19,6	32	○			
SVHCL 3225P22	6407129	32	25	170	19,6	32	○			

Rechtsausführung wie gezeichnet, Linksausführung spiegelbildlich
 Righthand version as shown, lefthand version mirrorlike

Ersatzteile Spare parts			Bestellbezeichnung Ordering Code			
SVH.R/L						
Schneid- kantenlänge Cutting edge length	Wendeplatte Indexable insert	Schaftgröße Shank size	Unterlage Shim	Gewindehülse Shim screw	Klemm- schraube Fixation screw	Schlüssel Key
11	VC...	1212-2525	-	-	A02-25059	V02-T0800
16	VC...	2020-3225	B09-V1602	E09-F5035	A02-35096	V05-T1534
r = 0,4-0,8	VB...	2020-2525	B02-V1431	E02-F5035	A02-35096	V05-T1534
16	VC...	2020-3225	B09-V1606	E09-F5035	A02-35096	V05-T1534
r = 1,2	VB...	2020-2525	B02-V1431	E02-F5035	A02-35096	V05-T1534
22	VC...	2020-3225	B09-V2222	E09-F6045	A02-45102	V05-T1534







Bestellbeispiel: 1 Stück SVHBR 2020K16
 Order example: 1 piece SVHBR 2020K16

Lieferung ohne Schlüssel
 Delivery without key

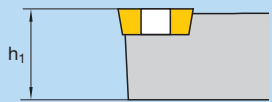
● Verfügbar ab Lager Available from stock
 ○ Auf Anfrage On request

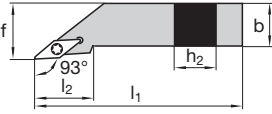
S-Klemmhalter Außenbearbeitung
Tool holders type S, external machining

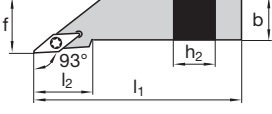

		Bestellbezeichnung Ordering Code	Ident No.	h ₁ = h ₂	b	l ₁	l ₂	f	Verfüg- barkeit Availa- bility	Passende Wende- platten Suitable inserts	Seite Page
SVJB-R/L	  	SVJBR 2020K16	6407143	20	20	125	34	25	●	VB.. 16..	56
		SVJBL 2020K16	6407140	20	20	125	34	25	●		
		SVJBR 2525M16	6407144	25	25	150	34	32	●		
		SVJBL 2525M16	6407141	25	25	150	34	32	●		
		SVJBR 3225P16	6407145	32	25	170	34	32	○		
		SVJBL 3225P16	6407142	32	25	170	34	32	●		
SVJC-R/L	  	SVJCR 1010X11-D	6424969	10	10	115	21,5	10	●	VC.. 11..	56-57
		SVJCL 1010X11-D	6424966	10	10	115	21,5	10	○		
		SVJCR 1212F11	6407153	12	12	100	-	16			
		SVJCL 1212F11	6407146	12	12	100	-	16			
		SVJCR 1212X11-D	6424970	12	12	130	21,5	12	●		
		SVJCL 1212X11-D	6424967	12	12	130	21,5	12	●		
		SVJCR 1616H11	6407154	16	16	100	21,5	20	●		
		SVJCL 1616H11	6407147	16	16	100	21,5	20	●		
		SVJCR 1616X11-D	6424971	16	16	130	21,5	16	●		
		SVJCL 1616X11-D	6424968	16	16	130	21,5	16	○		
		SVJCR 2020K11	6407155	20	20	125	23	25	●		
		SVJCL 2020K11	6407148	20	20	125	23	25	●		
		SVJCR 2525M11	6407157	25	25	150	25,5	32	●		
		SVJCL 2525M11	6407150	25	25	150	25,5	32	●		
		SVJCR 2020K16	6407156	20	20	125	29,5	25	●	VC.. 16..	57-58
		SVJCL 2020K16	6407149	20	20	125	29,5	25	●		
		SVJCR 2525M16	6407158	25	25	150	32,5	32	●		
		SVJCL 2525M16	6407151	25	25	150	32,5	32	●		
		SVJCR 3225P16	6407159	32	25	170	32,5	32	●		
		SVJCL 3225P16	6407152	32	25	170	32,5	32	●		

Rechtsausführung wie gezeichnet, Linksausführung spiegelbildlich
 Righthand version as shown, lefthand version mirrorlike

Ersatzteile Spare parts			Bestellbezeichnung Ordering Code			
SVJ.R/L						
Schneid- kantenlänge Cutting edge length	Wendeplatte Indexable insert	Schaftgröße Shank size	Unterlage Shim	Gewindehülse Shim screw	Klemm- schraube Fixation screw	Schlüssel Key
11	VC...	1212-2525	-	-	A02-25059	V02-T0800
16	VC...	2020-3225	B09-V1602	E09-F5035	A02-35096	V05-T1534
r = 0,4-0,8	VB...	2020-3225	B02-V1431	E02-F5035	A02-35096	V05-T1534
16	VC...	2020-3225	B09-V1606	E09-F5035	A02-35096	V05-T1534
r = 1,2	VB...	2020-3225	B02-V1431	E02-F5035	A02-35096	V05-T1534

Bestellbeispiel: 1 Stück SVJBR 2020K16
 Order example: 1 piece SVJBR 2020K16

Lieferung ohne Schlüssel
 Delivery without key

● Verfügbar ab Lager Available from stock
 ○ Auf Anfrage On request

S-Klemmhalter Außenbearbeitung

Tool holders type S, external machining

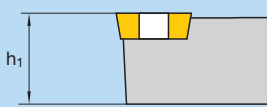
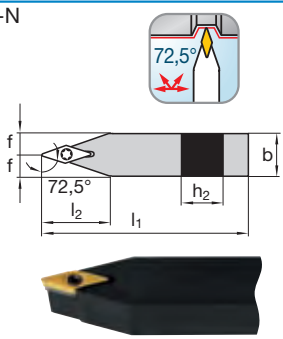
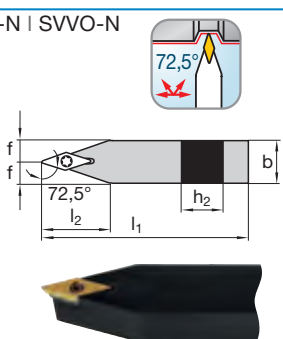
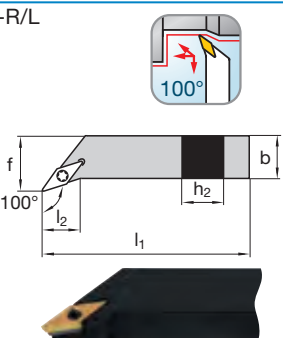

	Bestellbezeichnung		h ₁ = h ₂	b	l ₁	l ₂	f	Verfügbarkeit Availability	Passende Wende- platten Suitable inserts	Seite Page
	Ordering Code	Ident No.								
SVVB-N 	SVVBN 2020K16	6407166	20	20	125	32	10	●	VB.. 16..	56
	SVVBN 2525M16	6407167	25	25	150	40	12,5	●		
	SVVBN 3225P16	6407168	32	25	170	40	12,5	●		
SVVC-N SWVO-N 	SVVCN 1212F11	6407169	12	12	80	19	6	●	VC.. 11..	56-57
	SVVCN 1616H11	6407170	16	16	100	25	8	●		
	SVVCN 2020K11	6407171	20	20	125	32	10	●		
	SVVCN 2525M11	6407173	25	25	150	40	12,5	●		
	SVVCN 2020K16	6407172	20	20	125	32	10	●	VC.. 16..	57-58
	SVVCN 2525M16	6407174	25	25	150	40	12,5	●		
	SVVCN 3225P16	6407175	32	25	170	40	12,5	●		
SVZC-R/L 	SVZCR 2525M16	6407180	25	25	150	28,5	32	●	VC.. 16..	57-58
	SVZCL 2525M16	6407179	25	25	150	28,5	32	●		

Rechtsausführung wie gezeichnet, Linksausführung spiegelbildlich
 Righthand version as shown, lefthand version mirrorlike

Ersatzteile Spare parts			Bestellbezeichnung Ordering Code			
SV..						
Schneid- kantenlänge Cutting edge length	Wendeplatte Indexable insert	Schaftgröße Shank size	Unterlage Shim	Gewindehülse Shim screw	Klemm- schraube Fixation screw	Schlüssel Key
11	VC...	1212-2525	-	-	A02-25059	V02-T0800
16	VC...	2020-3225	B09-V1602	E09-F5035	A02-35096	V05-T1534
r = 0,4-0,8	VB...	2020-3225	B02-V1431	E02-F5035	A02-35096	V05-T1534
16	VC...	2020-3225	B09-V1606	E09-F5035	A02-35096	V05-T1534
r = 1,2	VB...	2020-3225	B02-V1431	E02-F5035	A02-35096	V05-T1534



Bestellbeispiel: 1 Stück SVVBN 2020K16
 Order example: 1 piece SVVBN 2020K16

Lieferung ohne Schlüssel
 Delivery without key

● Verfügbar ab Lager Available from stock
 ○ Auf Anfrage On request

S-Klemmhalter Außenbearbeitung
Tool holders type S, external machining

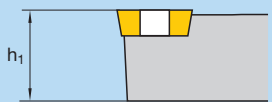
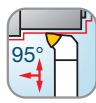
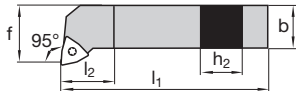

	Bestellbezeichnung Ordering Code		h ₁ = h ₂	b	l ₁	l ₂	f	Verfüg- barkeit Availa- bility	Passende Wende- platten Suitable inserts	Seite Page	
	Ident No.										
<p>SWLCR-R/L</p>   	SWLCR 1212F06	6407187	12	12	80	14	16	○	WC.. 06..	59	
		6407181	12	12	80	14	16	○			
	SWLCR 1616H06	6407188	16	16	100	16	20	●			
	SWLCL 1616H06	6407182	16	16	100	16	20	○			
	SWLCR 2020K06	6407190	20	20	125	16	25	●			
		SWLCL 2020K06	6407184	20	20	125	16	25	●		
		SWLCR 1616H08	6407189	16	16	100	17	20	○	WC.. 08..	59
		SWLCL 1616H08	6407183	16	16	100	17	20	○		
		SWLCR 2020K08	6407191	20	20	125	18	25	●		
		SWLCL 2020K08	6407185	20	20	125	18	25	●		
		SWLCR 2525M08	6407192	25	25	150	21	32	●		
		SWLCL 2525M08	6407186	25	25	150	21	32	●		



Rechtsausführung wie gezeichnet, Linksausführung spiegelbildlich
 Righthand version as shown, lefthand version mirrorlike

Ersatzteile Spare parts		Bestellbezeichnung Ordering Code			
SWLCR/L					
Schneid- kantenlänge Cutting edge length	Schaftgröße Shank size	Unterlage Shim	Gewindehülse Shim screw	Klemm- schraube Fixation screw	Schlüssel Key
06	1212	–	–	A02-35082	V02-T1500
06	1616–2020	B09-W0623	E09-F5035	A02-35082	V05-T1534
08	1616–2525	B09-W0831	E09-F6045	A02-45102	V05-T1534

Bestellbeispiel: 1 Stück SWLCR 1212F06
 Order example: 1 piece SWLCR 1212F06

Lieferung ohne Schlüssel
 Delivery without key

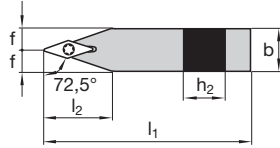
● Verfügbar ab Lager Available from stock
 ○ Auf Anfrage On request

	Bestellbezeichnung Ordering Code	Ident No.	h ₁	b	l ₁	Verfüg- barkeit Availability	Passende Wende- platten Suitable inserts	Seite Page
BM51576   	BM51576	5010414	20	20	130	●	XCGT26 XCGT28	62

Ersatzteile Spare parts BM51576	Bestellbezeichnung Ordering Code					
						
Unterlage Shim	Gewindehülse Shim screw	Klemm- schraube Fixation screw	Schlüssel Key			
-	-	A02-35096	V04-T1500			

Bestellbeispiel: 1 Stück BM51576
Order example: 1 piece BM51576

Lieferung ohne Schlüssel
Delivery without key

● Verfügbar ab Lager Available from stock
○ Auf Anfrage On request

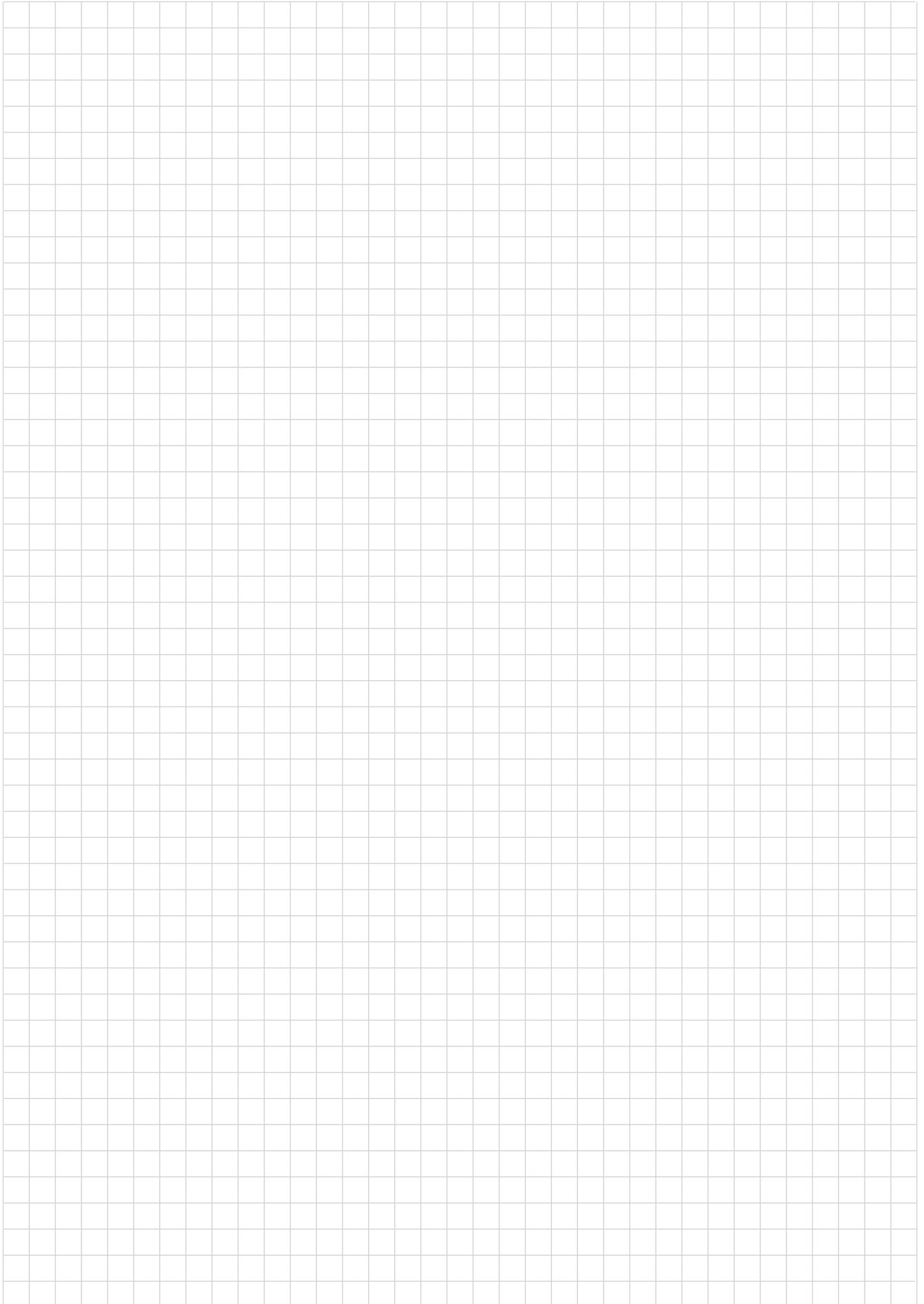

S- und P-Klemmhalter für die
Außenbearbeitung mit Innenkühlung
S- and P-Tool Holder for external
turning with coolant



S-Klemmhalter für Außenbearbeitung mit Innenkühlung
S-Tool holder for external turning with coolant



	Bestellbezeichnung Ordering Code	Ident No.	$h_1 = h_2$	b	l_1	f	Verfügbarkeit Availability	Passende Wendeplatten Suitable inserts	Seite Page
<p>SCLCR/L</p>	SCLCR 1616 H09- IK G1/8	5107113	16	16	100	20	●	CC.. 09T3..	34-35
	SCLCL 1616 H09- IK G1/8	5107115	16	16	100	20	●		
	SCLCR 2020 K09- IK G1/8	5107119	20	20	125	25	●		
	SCLCL 2020 K09- IK G1/8	5107120	20	20	125	25	●		
	SCLCR 2525 M12- IK G1/8	5107121	25	25	150	32	●	CC.. 1204..	34-35
	SCLCL 2525 M12- IK G1/8	5107122	25	25	150	32	●		

<p>SDJCR/L</p>	SDJCR 1616 H11- IK G1/8	5107123	16	16	100	20	●	DC.. 11T3..	41-43
	SDJCL 1616 H11- IK G1/8	5107124	16	16	100	20	●		
	SDJCR 2020 K11- IK G1/8	5107125	20	20	125	25	●		
	SDJCL 2020 K11- IK G1/8	5107126	20	20	125	25	●		
	SDJCR 2525 M11- IK G1/8	5107127	25	25	150	32	●		
	SDJCL 2525 M11- IK G1/8	5107128	25	25	150	32	●		

Ersatzteilliste für S-Klemmhalter
Spare part list for S-Tool holders

Ersatzteile für S-Klemmhalter Type Spare part for S-Tool holders	Unterlage Shim 	Gewindehülse Shim screw 	Klemmschraube Fixation screw 	Schlüssel Key
	Best.Bez. Ord. Code	Best.Bez. Ord. Code	Best.Bez. Ord. Code	Best.Bez. Ord. Code
SCLCR 1616 H09 - IK G1/8	B09-C0923	E09-F5035	A02-35096	V05-T1534
SCLCL 1616 H09 - IK G1/8	B09-C0923	E09-F5035	A02-35096	V05-T1534
SCLCR 2020 K09 - IK G1/8	B09-C0923	E09-F5035	A02-35096	V05-T1534
SCLCL 2020 K09 - IK G1/8	B09-C0923	E09-F5035	A02-35096	V05-T1534
SCLCR 2525 M12 - IK G1/8	B09-C1231	E09-F6045	A02-45102	V05-T1534
SCLCL 2525 M12 - IK G1/8	B09-C1231	E09-F6045	A02-45102	V05-T1534
SDJCR 1616 H11 - IK G1/8	B09-D1131	E09-F5035	A02-35096	V05-T1534
SDJCL 1616 H11 - IK G1/8	B09-D1131	E09-F5035	A02-35096	V05-T1534
SDJCR 2020 K11 - IK G1/8	B09-D1131	E09-F5035	A02-35096	V05-T1534
SDJCL 2020 K11 - IK G1/8	B09-D1131	E09-F5035	A02-35096	V05-T1534
SDJCR 2525 M11 - IK G1/8	B09-D1131	E09-F5035	A02-35096	V05-T1534
SDJCL 2525 M11 - IK G1/8	B09-D1131	E09-F5035	A02-35096	V05-T1534

Bestellbeispiel: 1 Stück SCLCR 1616 H09 - IK G1/8
 Order example: 1 piece SCLCR 1616 H09 - IK G1/8

● Verfügbar ab Lager Available from stock
 ○ Auf Anfrage On request

S-Klemmhalter für Außenbearbeitung mit Innenkühlung
S-Tool holder for external turning with coolant



Bestellbezeichnung Ordering Code	Ident No.	h ₁ = h ₂	b	l ₁	f	Verfüg- barkeit Availa- bility	Passende Wende- platten Suitable inserts	Seite Page	
	SVJCR 1616 H11-IK G1/8	5107129	16	16	100	20	●	VC.. 11T3..	56-58
	SVJCL 1616 H11-IK G1/8	5107130	16	16	100	20	●		
	SVJCR 2020 K11-IK G1/8	5107132	20	20	125	25	●		
	SVJCL 2020 K11-IK G1/8	5107133	20	20	125	25	●		
	SVJCR 2020 K16-IK G1/8	5107134	20	20	125	25	●		
	SVJCL 2020 K16-IK G1/8	5107135	20	20	125	25	●		
	SVJCR 2525 M16-IK G1/8	5107136	25	25	150	32	●	VC.. 1604..	56-58
	SVJCL 2525 M16-IK G1/8	5107137	25	25	150	32	●		

Bestellbeispiel: 1 Stück SVJCR 1616 H11 - IK G1/8
 Order example: 1 piece SVJCR 1616 H11 - IK G1/8

Ersatzteilliste für S-Klemmhalter
Spare part list for S-Tool holders

Ersatzteile für S-Klemmhalter Type Spare part for S-Tool holders	Unterlage Shim 	Gewindehülse Shim screw 	Klemmschraube Fixation screw 	Schlüssel Key
	Best.Bez. Ord. Code	Best.Bez. Ord. Code	Best.Bez. Ord. Code	Best.Bez. Ord. Code
SVJCR 1616 H11 - IK G1/8	-	-	A02-25059	V02-T0800
SVJCL 1616 H11 - IK G1/8	-	-	A02-25059	V02-T0800
SVJCR 2020 K11 - IK G1/8	-	-	A02-25059	V02-T0800
SVJCL 2020 K11 - IK G1/8	-	-	A02-25059	V02-T0800
SVJCR 2020 K16 - IK G1/8	1) 2)	E09-F5035	A02-35096	V05-T1534
SVJCL 2020 K16 - IK G1/8	1) 2)	E09-F5035	A02-35096	V05-T1534
SVJCR 2525 M16 - IK G1/8	1) 2)	E09-F5035	A02-35096	V05-T1534
SVJCL 2525 M16 - IK G1/8	1) 2)	E09-F5035	A02-35096	V05-T1534

Für for WSP insert VCMT 1604.. mit with:

- 1) s = 4,76 mm, r = 0,4; 0,8 mm / Unterlage shim B09-V1602
- 2) s = 4,76 mm, r = 1,2; 1,6 mm / Unterlage shim B09-V1606

- Verfügbar ab Lager Available from stock
- Auf Anfrage On request

P-Klemmhalter Außenbearbeitung mit Innenkühlung
P-Tool holder for external turning with coolant



	Bestellbezeichnung Ordering Code	Ident No.	h ₁ = h ₂	b	l ₁	f	Verfügbarkeit Availability	Passende Wendeplatten Suitable inserts	Seite Page
PCLNR/L 	PCLNR 1616 H12-IK G1/8	5107047	16	16	100	20	●	CN.. 1204..	36-40
	PCLNL 1616 H12-IK G1/8	5107049	16	16	100	20	●		
	PCLNR 2020 K12-IK G1/8	5107050	20	20	125	25	●		
	PCLNL 2020 K12-IK G1/8	5107051	20	20	125	25	●		
	PCLNR 2525 M12-IK G1/8	5107052	25	25	150	32	●		
	PCLNL 2525 M12-IK G1/8	5107055	25	25	150	32	●		
PDJNR/L 	PDJNR 1616 H11-IK G1/8	5107057	16	16	100	20	●	DN.. 1104..	43-46
	PDJNL 1616 H11-IK G1/8	5107059	16	16	100	20	●		
	PDJNR 2020 K15-IK G1/8	5107070	20	20	125	25	●	DN.. 1504..	
	PDJNL 2020 K15-IK G1/8	5107071	20	20	125	25	●	DN.. 1506..	
	PDJNR 2525 M15-IK G1/8	5107072	25	25	150	32	●	.	
	PDJNL 2525 M15-IK G1/8	5107073	25	25	150	32	●	.	

Bestellbeispiel: 1 Stück PCLNR 1616 H12 - IK G1/8
 Order example: 1 piece PCLNR 1616 H12 - IK G1/8

Ersatzteilliste für P-Klemmhalter
Spare part list for P-Tool holders

- Verfügbar ab Lager Available from stock
- Auf Anfrage On request

Ersatzteile für P-Klemmhalter Type Spare part for P-Tool holders	Unterlage Shim 	Gewindehülse Shim screw 	Klemmschraube Fixation screw 	Spannhülse Shim pin 	Montagedorn Assembly punch 	Schlüssel Key
	Best.Bez. Ord. Code	Best.Bez. Ord. Code	Best.Bez. Ord. Code	Best.Bez. Ord. Code	Best.Bez. Ord. Code	Best.Bez. Ord. Code
PCLNR 1616 H12 - IK G1/8	B01-C1231	D02-12130	A03-08210	E01-07205	V10-20000	V01-A0030
PCLNL 1616 H12 - IK G1/8	B01-C1231	D02-12130	A03-08210	E01-07205	V10-20000	V01-A0030
PCLNR 2020 K12 - IK G1/8	B01-C1231	D02-12130	A03-08210	E01-07205	V10-20000	V01-A0030
PCLNL 2020 K12 - IK G1/8	B01-C1231	D02-12130	A03-08210	E01-07205	V10-20000	V01-A0030
PCLNR 2525 M12 - IK G1/8	B01-C1231	D02-12130	A03-08210	E01-07205	V10-20000	V01-A0030
PCLNL 2525 M12 - IK G1/8	B01-C1231	D02-12130	A03-08210	E01-07205	V10-20000	V01-A0030
PDJNR 1616 H11 - IK G1/8	B01-D1131	D02-10120	A03-06170	E01-05405	V10-10000	V01-A0025
PDJNL 1616 H11 - IK G1/8	B01-D1131	D02-10120	A03-06170	E01-05405	V10-10000	V01-A0025
PDJNR 2020 K15 - IK G1/8	1) 2) 3) 4)	D02-15145	A03-08210	E01-07205	V10-20000	V01-A0030
PDJNL 2020 K15 - K G1/8	1) 2) 3) 4)	D02-15145	A03-08210	E01-07205	V10-20000	V01-A0030
PDJNR 2525 M15 - IK G1/8	1) 2) 3) 4)	D02-15145	A03-08210	E01-07205	V10-20000	V01-A0030
PDJNL 2525 M15 - IK G1/8	1) 2) 3) 4)	D02-15145	A03-08210	E01-07205	V10-20000	V01-A0030

Für for WSP insert DNMG 1504.. mit with:

- 1) s = 4,76 mm, r = 0,4; 0,8 mm / Unterlage shim B01-D1448
- 2) s = 4,76 mm, r = 1,2; 1,6 mm / Unterlage shim B01-D1447

Für for WSP insert DNMG 1506.. mit with:

- 3) s = 6,35 mm, r = 0,4; 0,8 mm / Unterlage shim B01-D1432
- 4) s = 6,35 mm, r = 1,2; 1,6 mm / Unterlage shim B01-D1431

P-Klemmhalter Außenbearbeitung mit Innenkühlung
P-Tool holder for external turning with coolant



	Bestellbezeichnung Ordering Code	Ident No.	h_1	h_2	b	l_1	f	Verfügbarkeit Availability	Passende Wendeplatten Suitable inserts	Seite Page
			=							
	PWLNLR 1616 H06-IK G1/8	5107074	16	16	100	20	●	WN.. 0604..	59-62	
	PWLNLL 1616 H06-IK G1/8	5107075	16	16	100	20	●			
	PWLNLR 2020 K08-IK G1/8	5107076	20	20	125	25	●	WN.. 0804..		
	PWLNLL 2020 K08-IK G1/8	5107078	20	20	125	25	●			
	PWLNLR 2525 M08-IK G1/8	5107079	25	25	150	32	●			
	PWLNLL 2525 M08-IK G1/8	5107080	25	25	150	32	●			

Bestellbeispiel: 1 Stück PWLNLR 1616 H06 - IK G1/8
 Order example: 1 piece PWLNLR 1616 H06 - IK G1/8

Ersatzteilliste für P-Klemmhalter
Spare part list for P-Tool holders

- Verfügbar ab Lager Available from stock
- Auf Anfrage On request

Ersatzteile für P-Klemmhalter Type Spare part for P-Tool holders	Unterlage Shim 	Gewindehülse Shim screw 	Klemmschraube Fixation screw 	Spannhülse Shim pin 	Montagedorn Assembly punch 	Schlüssel Key
	Best.Bez. Ord. Code	Best.Bez. Ord. Code	Best.Bez. Ord. Code	Best.Bez. Ord. Code	Best.Bez. Ord. Code	Best.Bez. Ord. Code
PWLNLR 1616 H06 - IK G1/8	B01-W0627	D02-09120	A03-06170	E01-05807	V10-10000	V01-A0025
PWLNLL 1616 H06 - IK G1/8	B01-W0627	D02-09120	A03-06170	E01-05807	V10-10000	V01-A0025
PWLNLR 2020 K08 - IK G1/8	B01-W0831	D02-12130	A03-08210	E01-07205	V10-20000	V01-A0030
PWLNLL 2020 K08 - IK G1/8	B01-W0831	D02-12130	A03-08210	E01-07205	V10-20000	V01-A0030
PWLNLR 2525 M08 - IK G1/8	B01-W0831	D02-12130	A03-08210	E01-07205	V10-20000	V01-A0030
PWLNLL 2525 M08 - IK G1/8	B01-W0831	D02-12130	A03-08210	E01-07205	V10-20000	V01-A0030

Klemmhalter mit Anschlüsse für die Kühlmittelzufuhr
Tool holder with port for coolant

(max. Kühlmitteldruck 80 bar)
(max. coolant pressure 80 bar)

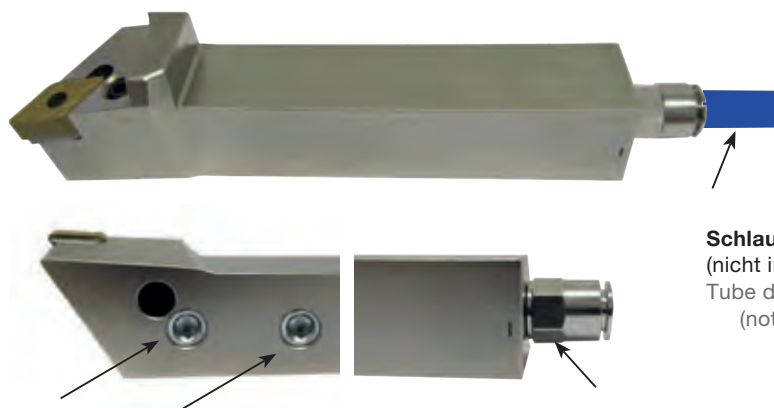

Schlauch Durchmesser 8 mm
 (nicht inkludiert!)
 Tube diameter 8mm
 (not included)

**2 x optionale
Kühlmittelzufuhr**
 2 x optional Coolant
Anschlussgewinde G1/8"
 Connection thread G1/8"

Kühlmittelzufuhr
 Coolant
Anschlussgewinde G1/8"
 Connection thread G1/8"

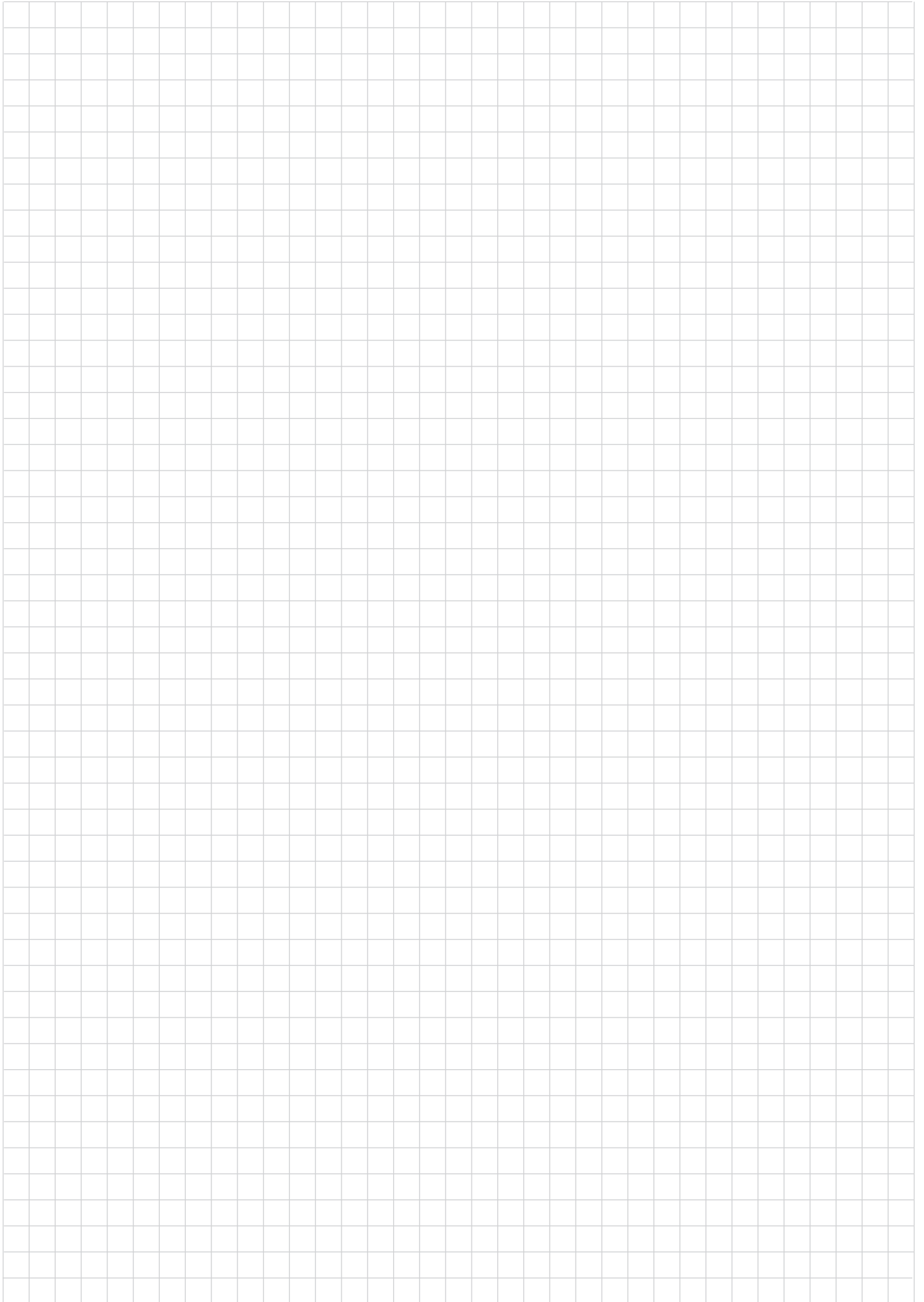





Klemmhalter
Innenbearbeitung
Tool holders
internal machining

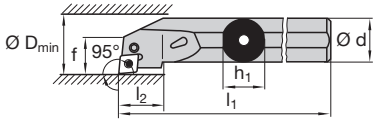

P-Klemmhalter Innenbearbeitung
Tool holders type P, internal machining

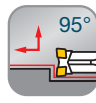
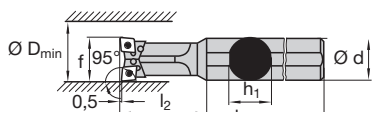

	Bestellbezeichnung Ordering Code	Ident No.	d	h ₁	l ₁	l ₂	f	D _{min}	Verfügbarkeit Availability	Passende Wendeplatten Suitable inserts	Seite Page		
PCLN-R/L   	A25R-PCLNR 12	6401488	25	24	200	21	17	31,5	●	CN.. 12..	36-40		
	A25R-PCLNL 12	6401487	25	24	200	21	17	31,5	●				
	A32S-PCLNR 12	6401557	32	31	250	24,1	22	40	●				
	A32S-PCLNL 12	6401556	32	31	250	24,1	22	40	●				
	A40T-PCLNR 12	6401598	40	39	300	24,1	27	49	●				
	A40T-PCLNL 12	6401597	40	39	300	24,1	27	49	●				
	S25T-PCLNR 12	6407249	25	23	300	22	17	32	●				
	S25T-PCLNL 12	6407248	25	23	300	22	17	32	●				
	S32U-PCLNR 12	6407282	32	30	350	24,1	22	40	●				
	S32U-PCLNL 12	6407281	32	30	350	24,1	22	40	●				
	S40V-PCLNR 12	6407308	40	37	400	24,1	27	49	●				
	S40V-PCLNL 12	6407307	40	37	400	24,1	27	49	●				
	S50W-PCLNR 16	6407329	50	47	450	31	35	62	●			CN.. 16..	37-40
	S50W-PCLNL 16	6407328	50	47	450	31	35	62	○				
29629 / 29529   	S40S-29629 12	6407298	40	-	250	80	40	45	●	CN.. 12..	36-40		
	S50S-29529 12	6407325	50	-	250	100	50	55	●				

A = Stahlschaft mit Kühlbohrung Steel shank with coolant hole
 S = Stahlschaft Steel shank

Rechtsausführung wie gezeichnet, Linksausführung spiegelbildlich
 Righthand version as shown, lefthand version mirrorlike

Ersatzteile Spare parts		Bestellbezeichnung Ordering Code					
PC.NR/L							
Schneidkantenlänge Cutting edge length	Schaftdurchmesser Ø d Shank diameter Ø d	Unterlage Shim	Hebel Lever	Spannschraube Fixation screw	Spannhülse Shim pin	Montagedorn Assembly punch	Schlüssel Key
12	25-32	B01-C1231	D02-12130	A03-08170	E01-07205	V10-20000	V01-A0030
12	40-50	B01-C1231	D02-12130	A03-08210	E01-07205	V10-20000	V01-A0030
16	50	B01-C1547	D02-15173	A03-08235	E01-09008	V10-40000	V01-A0030







Bestellbeispiel: 1 Stück A25R-PCLNR 12
 Order example: 1 piece A25R-PCLNR 12

Lieferung ohne Schlüssel
 Delivery without key

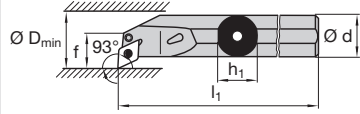
- Verfügbar ab Lager Available from stock
- Auf Anfrage On request

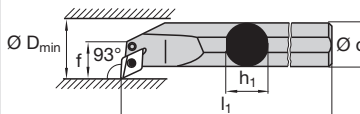
P-Klemmhalter Innenbearbeitung
Tool holders type P, internal machining

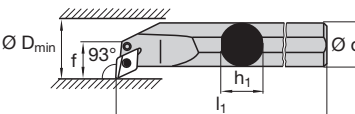

	Bestellbezeichnung Ordering Code	Ident No.	d	h ₁	l ₁	l ₂	f	D _{min}	Verfügbarkeit Availability	Passende Wende- platten Suitable inserts	Seite Page	
PDUN-R/L   	A20Q-PDUNR 11	6401452	20	19	180	-	16	27	●	DN.. 11..	43-44	
	A20Q-PDUNL 11	6401451	20	19	180	-	16	27	●			
	A25R-PDUNR 11	6401490	25	24	200	-	18,5	32	●			
	A25R-PDUNL 11	6401489	25	24	200	-	18,5	32	●			
	A32S-PDUNR 11	6401560	32	31	250	-	22	40	○			
	A32S-PDUNL 11	6401558	32	31	250	-	22	40	○			
	PDUN-R/L 14   	A32S-PDUNR 15	6401561	32	31	250	-	22	40	●	DN.. 15..	43-46
		A32S-PDUNL 15	6401559	32	31	250	-	22	40	●		
		A40T-PDUNR 15	6401600	40	39	300	-	27	49	●		
		A40T-PDUNL 15	6401599	40	39	300	-	27	49	●		
		S40V-PDUNR 15	6407310	40	37	400	-	27	49	●		
		S40V-PDUNL 15	6407309	40	37	400	-	27	49	●		
		S50W-PDUNR 15	6407331	50	47	450	-	35	62	●		
		S50W-PDUNL 15	6407330	50	47	450	-	35	62	●		
PDUN-R/L 14   	S32T-PDUNR 14	6407270	32	30	300	-	22	40	●	DNMG 14..	45	
	S32T-PDUNL 14	6407269	32	30	300	-	22	40	●			
	S40U-PDUNR 14	6407304	40	38	350	-	27	50	○			
	S40U-PDUNL 14	6407303	40	38	350	-	27	50	○			

A = Stahlschaft mit Kühlbohrung Steel shank with coolant hole
 S = Stahlschaft Steel shank

Rechtsausführung wie gezeichnet, Linksausführung spiegelbildlich
 Righthand version as shown, lefthand version mirrorlike

Ersatzteile Spare parts		Bestellbezeichnung Ordering Code						
PDUNR/L								
Schneid- kantenlänge Cutting edge length	Schaftdurch- messer Ø d Shank diameter Ø d	Unterlage Shim	Hebel Lever	Spann- schraube Fixation screw	Spannhülse Shim pin	Montagedorn Assembly punch	Schlüssel Key	
11	20	-	D02-11105	A03-06135	-	V10-10000	V01-A0025	
11	25-32	B01-D1131	D02-10120	A03-06170	E01-05405	V10-10000	V01-A0025	
14	32-40	B01-D1331	D02-15145	A03-08210	E01-07205	V10-20000	V01-A0030	
15 ¹⁾	32-50	B01-D1448	D02-15145	A03-08210	E01-07205	V10-20000	V01-A0030	
15 ²⁾	32-50	B01-D1447	D02-15145	A03-08210	E01-07205	V10-20000	V01-A0030	
15 ³⁾	32-50	B01-D1432	D02-15145	A03-08210	E01-07205	V10-20000	V01-A0030	
15 ³⁾	32-50	B01-D1431	D02-15145	A03-08210	E01-07205	V10-20000	V01-A0030	

Für WSP DNMG 1504../ for insert DNMG 1504..

¹⁾ s = 4,76 mm, r = 0,4; 0,8 mm

²⁾ s = 4,76 mm, r = 1,2; 1,6 mm

Für WSP DNMG 1506../ for insert DNMG 1506..

³⁾ s = 6,35 mm, r = 0,4; 0,8 mm

⁴⁾ s = 6,35 mm, r = 1,2; 1,6 mm





Bestellbeispiel: 1 Stück A20Q-PDUNR 11
 Order example: 1 piece A20Q-PDUNR 11

Lieferung ohne Schlüssel
 Delivery without key

● Verfügbar ab Lager Available from stock
 ○ Auf Anfrage On request

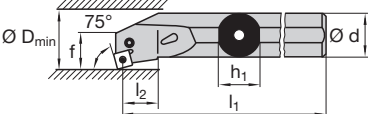

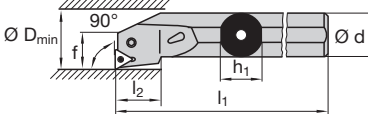



P-Klemmhalter Innenbearbeitung
Tool holders type P, internal machining



	Bestellbezeichnung Ordering Code	Ident No.	d	h ₁	l ₁	l ₂	f	D _{min}	Verfügbarkeit Availability	Passende Wendeplatten Suitable inserts	Seite Page			
PSKN-R/L   	A25R-PSKNR 12	6401492	25	24	200	15,5	17	31,5	●	SN.. 12..	49-52			
	A25R-PSKNL 12	6401491	25	24	200	15,5	17	31,5	●					
	A32S-PSKNR 12	6401563	32	31	250	16	22	40	○					
	A32S-PSKNL 12	6401562	32	31	250	16	22	40	○					
	A40T-PSKNR 12	6401602	40	39	300	23	27	49	○					
	A40T-PSKNL 12	6401601	40	39	300	23	27	49	○					
	S50W-PSKNR 15 S50W-PSKNL 15	6407333	50	47	450	30	35	62	●	SN.. 15..	51-52			
		6407332	50	47	450	30	35	62	○					
		PTFN-R/L   	A25R-PTFNR 16	6401494	25	24	200	17,5	17	31,5		●	TN.. 16..	54-55
			A25R-PTFNL 16	6401493	25	24	200	17,5	17	31,5		●		
A32S-PTFNR 16	6401565		32	31	250	18	22	40	○					
A32S-PTFNL 16	6401564		32	31	250	18	22	40	○					
A40T-PTFNR 22 A40T-PTFNL 22	6401604		40	39	300	27	27	49	●	TN.. 22..	54-55			
	6401603		40	39	300	27	27	49	○					
S25T-PTFNR 16 S25T-PTFNL 16	6407251		25	23	300	17,5	17	32	●	TN.. 16..	54-55			
	6407250		25	23	300	17,5	17	32	○					
S50W-PTFNR 22 S50W-PTFNL 22	6407335		50	47	450	35	35	62	●	TN.. 22..	54-55			
	6407334		50	47	450	35	35	62	○					

A = Stahlschaft mit Kühlbohrung Steel shank with coolant hole
S = Stahlschaft Steel shank

Rechtsausführung wie gezeichnet, Linksausführung spiegelbildlich
Righthand version as shown, lefthand version mirrorlike

Ersatzteile Spare parts		Bestellbezeichnung Ordering Code						
P..NR/L								
Schneidkantenlänge Cutting edge length	Schaftdurchmesser Ø d Shank diameter Ø d	Unterlage Shim	Hebel Lever	Spannschraube Fixation screw	Spannhülse Shim pin	Montagedorn Assembly punch	Schlüssel Key	
12	25-32	B01-S1231	D02-12130	A03-08170	E01-07205	V10-20000	V01-A0030	
12	40	B01-S1231	D02-12130	A03-08210	E01-07210	V10-20000	V01-A0030	
15	50	B01-S1547	D02-15173	A03-08235	E01-09008	V10-40000	V01-A0030	
								
16	25-32	B01-T1527	D02-09120	A03-06170	E01-05405	V10-10000	V01-A0025	
22	40-50	B01-T2031	D02-12130	A03-08210	E01-07205	V10-20000	V01-A0030	



Bestellbeispiel: 1 Stück A25R-PSKNR 12
Order example: 1 piece A25R-PSKNR 12

Lieferung ohne Schlüssel
Delivery without key

● Verfügbar ab Lager Available from stock
○ Auf Anfrage On request

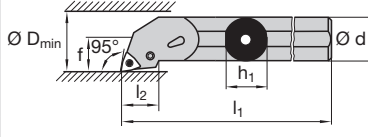

P-Klemmhalter Innenbearbeitung
Tool holders type P, internal machining



		Bestellbezeichnung Ordering Code	Ident No.	d	h ₁	l ₁	l ₂	f	D _{min}	Verfügbarkeit Availability	Passende Wendeplatten Suitable inserts	Seite Page
PWLN-R/L   	A16M-PWLNR 06	6401408	16	15,25	150	17,5	11	21	●	WN.. 06..	59-61	
	A16M-PWLNL 06	6401407	16	15,25	150	17,5	11	21	●			
	A20Q-PWLNR 06	6401454	20	19	180	19,5	13	25	●			
	A20Q-PWLNL 06	6401453	20	19	180	19,5	13	25	●			
	A25R-PWLNR 06	6401496	25	24	200	19,5	17	32	●			
	A25R-PWLNL 06	6401495	25	24	200	19,5	17	32	●			
	A32S-PWLNR 08	6401567	32	31	250	26	22	40	●	WN.. 08..	59-62	
	A32S-PWLNL 08	6401566	32	31	250	26	22	40	●			
	A40T-PWLNR 08	6401606	40	38,5	300	26	27	49	●			
	A40T-PWLNL 08	6401605	40	38,5	300	26	27	49	●			

A = Stahlschaft mit Kühlbohrung Steel shank with coolant hole

Rechtsausführung wie gezeichnet, Linksausführung spiegelbildlich
 Righthand version as shown, lefthand version mirrorlike

Ersatzteile Spare parts		Bestellbezeichnung Ordering Code					
PWLNR/L							
Schneidkantenlänge Cutting edge length	Schaftdurchmesser Ø d Shank diameter Ø d	Unterlage Shim	Hebel Lever	Spannschraube Fixation screw	Spannhülse Shim pin	Montagedorn Assembly punch	Schlüssel Key
06	16 – 20	–	D02-09093	A03-05120	–	–	V01-A0020
06	25	B01-W0627	D02-09120	A03-06170	E01-05405	V10-10000	V01-A0025
08	32 – 40	B01-W0831	D02-12130	A03-08210	E01-07205	V10-20000	V01-A0030



Bestellbeispiel: 1 Stück A16M-PWLNR 06
 Order example: 1 piece A16M-PWLNR 06

Lieferung ohne Schlüssel
 Delivery without key

● Verfügbar ab Lager Available from stock
 ○ Auf Anfrage On request

S-Klemmhalter Innenbearbeitung
Tool holders type S, internal machining

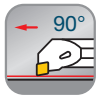
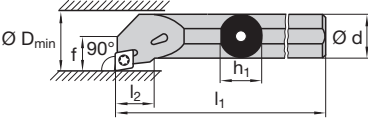

	Bestellbezeichnung Ordering Code	Ident No.	d	h ₁	l ₁	l ₂	f	D _{min}	Verfügbarkeit Availability	Passende Wende- platten Suitable inserts	Seite Page
SCFC-R/L   	A08F-SCFCR 06	6401298	8	7,5	80	–	5	11	●	CC.. 06..	34-35
	A08F-SCFCL 06	6401297	8	7,5	80	–	5	11	●		
	A10H-SCFCR 06	6401333	10	9,5	100	9	7	14	●		
	A10H-SCFCL 06	6401332	10	9,5	100	9	7	14	●		
	A12K-SCFCR 06	6401358	12	11,5	125	14	9	17	●		
	A12K-SCFCL 06	6401357	12	11,5	125	14	9	17	○		

A = Stahlschaft mit Kühlbohrung Steel shank with coolant hole
 S = Stahlschaft Steel shank
 E = Hartmetall-Schaft mit Stahlkopf und Kühlbohrung
 Carbide shank with steel head and coolant hole

Rechtsausführung wie gezeichnet, Linksausführung spiegelbildlich
 Righthand version as shown, lefthand version mirrorlike

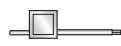
Ersatzteile Spare parts SCFCR/L		Bestellbezeichnung Ordering Code					
Schneid- kantenlänge Cutting edge length	Schaftdurch- messer Ø d Shank diameter Ø d	 Unterlage Shim	 Gewindehülse Shim screw	 Klemm- schraube Fixation screw	 Schlüssel Key		
06	08 – 12	–	–	A02-25059	V02-T0800		



Bestellbeispiel: 1 Stück A08F-SCFCR 06
 Order example: 1 piece A08F-SCFCR 06



Lieferung ohne Schlüssel
 Delivery without key

● Verfügbar ab Lager Available from stock
 ○ Auf Anfrage On request

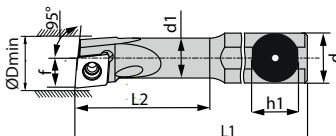
S-Klemmhalter Innenbearbeitung
Tool holders type S, internal machining

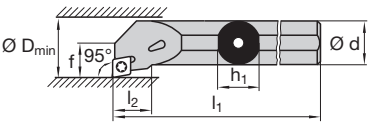

SCLC-R/L	  	Bestellbezeichnung	Ident No.	d ₁	d	h ₁	l ₁	l ₂	f	D _{min}	Verfügbarkeit	Passende	Seite
		Ordering Code										Availability	Wendeplatten inserts
		A0608H-SCLCR 06	5111795	6	8	7	100	21,5	4,2	8	●	CC.. 06..	34-35
		A0608H-SCLCL 06	5111980	6	8	7	100	21,5	4,2	8	●		
		A0810J-SCLCR 06	5111982	8	10	9	110	27	6	11	●		
		A0810J-SCLCL 06	5111984	8	10	9	110	27	6	11	●		
		A1012K-SCLCR 06	5111985	10	12	11	125	32,5	7	13	●		
		A1012K-SCLCL 06	5111986	10	12	11	125	32,5	7	13	●		
		A1216M-SCLCR 06	5111988	12	16	15	150	42	9	16	●		
		A1216M-SCLCL 06	5111989	12	16	15	150	42	9	16	●		

SCLC-R/L	  	Bestellbezeichnung	Ident No.	d	h ₁	l ₁	l ₂	f	D _{min}	Verfügbarkeit	Passende	Seite		
		Ordering Code									Availability	Wendeplatten inserts	Page	
		A08F-SCLCR 06	6401300	8	7,5	80	-	5	11	●	CC.. 06..	34-35		
		A08F-SCLCL 06	6401299	8	7,5	80	-	5	11	●				
		A08H-SCLCR 06	5112082	8	7	100	17,8	6	10	●				
		A08H-SCLCL 06	5112083	8	7	100	17,8	6	10	●				
		A10H-SCLCR 06	6401335	10	9,5	100	10	7	13	●				
		A10H-SCLCL 06	6401334	10	9,5	100	10	7	13	●				
		A10K-SCLCR 06	5112084	10	9	125	17,7	7	12	●				
		A10K-SCLCL 06	5112085	10	9	125	17,7	7	12	●				
		A12K-SCLCR 06	6401360	12	11,5	125	10	9	16	●				
		A12K-SCLCL 06	6401359	12	11,5	125	10	9	16	●				
		A12L-SCLCR 06	5112086	12	11	140	24,2	9	16	○				
		A12L-SCLCL 06	5112087	12	11	140	24,2	9	16	○				
		A16M-SCLCR 09	6401410	16	15,5	150	16	11	20	●			CC.. 09..	34-35
		A16M-SCLCL 09	6401409	16	15,5	150	16	11	20	●				
		A16Q-SCLCR 09	5112088	16	15	180	26,7	11	20	○				
		A16Q-SCLCL 09	5112089	16	15	180	26,7	11	20	○				
		A20Q-SCLCR 09	6401456	20	19	180	16	13	25	●				
		A20Q-SCLCL 09	6401455	20	19	180	16	13	25	●				
		A20R-SCLCR 09	5112090	25	24	200	16	17	31,5	●				
		A20R-SCLCL 09	5112091	20	19	200	16	17	31,5	●				
		A25R-SCLCR 09	6401498	20	19	200	16	17	31,5	●	CC.. 12..	34-35		
		A25R-SCLCL 09	6401497	25	24	200	16	17	31,5	●				
		A32S-SCLCR 12	6401569	32	31	250	22	22	40	●				
		A32S-SCLCL 12	6401568	32	31	250	22	22	40	●				
		A40T-SCLCR 12	6401608	40	38,5	300	22	27	49	●				
		A40T-SCLCL 12	6401607	40	38,5	300	22	27	49	●				

A = Stahlschaft mit Kühlbohrung Steel shank with coolant hole

Rechtsausführung wie gezeichnet, Linksausführung spiegelbildlich
 Righthand version as shown, lefthand version mirrorlike

Ersatzteile Spare parts		Bestellbezeichnung Ordering Code				
SCLCR/L						
Schneidkantenlänge Cutting edge length	Schaftdurchmesser Ø d Shank diameter Ø d	Unterlage Shim	Gewindehülse Shim screw	Klemmschraube Fixation screw	Schlüssel Key	
06	08-12	-	-	A02-25059	V02-T0800	
09	16-20	-	-	A02-35082	V02-T1500	
09	25	-	-	A02-35096	V02-T1500	
12	32-40	B09-C1231	E09-F6045	A02-45102	V05-T1534	

Bestellbeispiel: 1 Stück A0608H-SCLCR 06
 Order example: 1 piece A0608H-SCLCR 06

Lieferung ohne Schlüssel
 Delivery without key

● Verfügbar ab Lager Available from stock
 ○ Auf Anfrage On request

S-Klemmhalter Innenbearbeitung
Tool holders type S, internal machining



		Bestellbezeichnung Ordering Code	Ident No.	d	h ₁	l ₁	l ₂	f	D _{min}	Verfügbarkeit Availability	Passende Wendeplatten Suitable inserts	Seite Page		
		E08H-SCLCR 06	6404753	8	7,5	100	–	5	11	●	CC.. 06..	34-35		
		E08H-SCLCL 06	6404752	8	7,5	100	–	5	11	●				
		E08K-SCLCR 06	5119312	8	7	125	10	5	10	○				
		E08K-SCLCL 06	5119313	8	7	125	10	5	10	○				
		E10K-SCLCR 06	6404765	10	9,5	125	10	7	14	●				
		E10K-SCLCL 06	6404764	10	9,5	125	10	7	14	●				
		E12M-SCLCR 06	5119316	12	11	150	10	8	14	○				
		E12M-SCLCL 06	5119317	12	11	150	10	8	14	○				
		E12Q-SCLCR 06	6404774	12	11	180	10	8	14	●				
		E12Q-SCLCL 06	6404773	12	11	180	10	8	14	●				
				E16R-SCLCR 09	6404802	16	15,5	200	16	11	21	●	CC.. 09..	34-35
				E16R-SCLCL 09	6404801	16	15,5	200	16	11	21	●		
				E20S-SCLCR 09	6404854	20	19	250	16	13	25	●		
				E20S-SCLCL 09	6404853	20	19	250	16	13	25	●		
				E25T-SCLCR 09	6404886	25	24	300	16	17	31,5	●		
				E25T-SCLCL 09	6404885	25	24	300	16	17	31,5	●		
				S08H-SCLCR 06	6407199	8	7	100	–	5	11	●	CC.. 06..	34-35
				S08H-SCLCL 06	6407198	8	7	100	–	5	11	●		
				S10K-SCLCR 06	6407203	10	9	125	10	7	13	●		
				S10K-SCLCL 06	6407202	10	9	125	10	7	13	●		
				S12Q-SCLCR 06	6407207	12	11	180	10	9	16	●		
				S12Q-SCLCL 06	6407206	12	11	180	10	9	16	●		
				S16R-SCLCR 09	6407213	16	15	200	16	11	20	●	CC.. 09..	34-35
				S16R-SCLCL 09	6407212	16	15	200	16	11	20	●		
				S20S-SCLCR 09	6407229	20	18	250	16	13	25	●		
				S20S-SCLCL 09	6407228	20	18	250	16	13	25	●		
				S25T-SCLCR 09	6407255	25	23	300	16	17	31,5	●		
		S25T-SCLCL 09	6407253	25	23	300	16	17	31,5	○				
		S25T-SCLCR 12	6407256	25	23	300	16	17	31,5	●	CC.. 12..	34-35		
		S25T-SCLCL 12	6407254	25	23	300	16	17	31,5	○				

Bestellbeispiel: 1 Stück E08H-SCLCR 06
 Order example: 1 piece E08H-SCLCR 06

Rechtsausführung wie gezeichnet, Linksausführung spiegelbildlich
 Righthand version as shown, lefthand version mirrorlike

A = Stahlschaft mit Kühlbohrung Steel shank with coolant hole
 S = Stahlschaft Steel shank
 E = Hartmetall-Schaft mit Stahlkopf und Kühlbohrung
 Carbide shank with steel head and coolant hole

Ersatzteile Spare parts SCLCR/L		Bestellbezeichnung Ordering Code			
Schneidkantenlänge Cutting edge length	Schaftdurchmesser Ø d Shank diameter Ø d	Unterlage Shim	Gewindehülse Shim screw	Klemmschraube Fixation screw	Schlüssel Key
06	08 – 12	–	–	A02-25059	V02-T0800
09	16 – 20	–	–	A02-35082	V02-T1500
09	25	–	–	A02-35096	V02-T1500
12	32 – 40	B09-C1231	E09-F6045	A02-45102	V05-T1534

Lieferung ohne Schlüssel
 Delivery without key

● Verfügbar ab Lager Available from stock
 ○ Auf Anfrage On request

S-Klemmhalter Innenbearbeitung
Tool holders type S, internal machining



	Bestellbezeichnung										Verfügbarkeit	Passende	Seite
	Ordering Code												
SDQCR/L	Ident No.	d ₁	d	h ₁	l ₁	l ₂	f	D _{min}					
	A0408F-SDQCR 04	5140210	-	8	7	80	15	2,6	5,2	○	DC.. 04..	41-43	
	A0408F-SDQCL 04	5140212	-	8	7	80	15	2,6	5,2	○			
	A0810H-SDQCR 07	5111999	-	10	9	100	22,4	6,4	12,5	●	DC.. 07..	41-43	
	A0810H-SDQCL 07	5112000	-	10	9	100	22,4	6,4	12,5	●			
	A1012K-SDQCR 07	5112002	-	12	11	125	27,5	9	15,5	●			
	A1012K-SDQCL 07	5112003	-	12	11	125	27,5	9	15,5	●			
	A1216M-SDQCR 07	5112004	-	16	15	150	39,5	11	19,5	●			
	A1216M-SDQCL 07	5112007	-	16	15	150	39,5	11	19,5	●			
	E0408F-SDQCR 04	5140213	-	8	7	80	15	2,6	5,2	○	DC.. 04..	41-43	
	E0408F-SDQCL 04	5140214	-	8	7	80	15	2,6	5,2	○			

	Bestellbezeichnung										Verfügbarkeit	Passende	Seite
	Ordering Code												
SDQC-R/L	Ident No.	d	h ₁	l ₁	l ₂	f	D _{min}						
	A10H-SDQCR 07	6410851	10	9	100	10	7	14	●	DC.. 07..	41-43		
	A10H-SDQCL 07	6410850	10	9	100	10	7	14	●				
	A12K-SDQCR 07	6401362	12	11,5	125	12,5	9	17	●				
	A12K-SDQCL 07	6401361	12	11,5	125	12,5	9	17	●				
	A16M-SDQCR 07	6401412	16	15,5	150	16,5	11	21	●				
	A16M-SDQCL 07	6401411	16	15,5	150	16,5	11	21	●				
	A20Q-SDQCR 07	6401458	20	19	180	20,5	13	25	●				
	A20Q-SDQCL 07	6401457	20	19	180	20,5	13	25	●				
	A25R-SDQCR 11	6401500	25	24	200	26,5	17	31,5	●	DC.. 11..	41-43		
	A25R-SDQCL 11	6401499	25	24	200	26,5	17	31,5	●				
	A32S-SDQCR 11	6401571	32	31	250	33,5	22	40	●				
	A32S-SDQCL 11	6401570	32	31	250	33,5	22	40	●				
	A40T-SDQCR 11	6401610	40	38,5	300	41,5	27	49	●				
	A40T-SDQCL 11	6401609	40	38,5	300	41,5	27	49	●				
	E08K-SDQCR 07	5119322	8	7	125	10	7	12	●	DC.. 07..	41-43		
	E08K-SDQCL 07	5119323	8	7	125	10	7	12	●				
	E10K-SDQCR 07	5119324	10	9	125	10	7	13	●				
	E10K-SDQCL 07	5119325	10	9	125	10	7	13	●				
	E12M-SDQCR 07	5119326	12	11	150	12,5	8,5	16	●				
	E12M-SDQCL 07	5119327	12	11	150	12,5	8,5	16	●				

Bestellbeispiel: 1 Stück A0408F-SDQCR 04
 Order example: 1 piece A0408F-SDQCR 04

A = Stahlschaft mit Kühlbohrung Steel shank with coolant hole
 E = Hartmetall-Schaft mit Stahlkopf und Kühlbohrung
 Carbide shank with steel head and coolant hole

Ersatzteile Spare parts		Bestellbezeichnung Ordering Code				
SDQCR/L						
Schneidkantenlänge	Schaftdurchmesser Ø d					
Cutting edge length	Shank diameter Ø d	Unterlage Shim	Gewindehülse Shim screw	Klemmschraube Fixation screw	Schlüssel Key	
04	8	-	-	-	V02-T0500	
07	12-20	-	-	A02-25059	V02-T0800	
11	20	-	-	A02-35072	V02-T1500	
11	25-40	B09-D1131	E09-F5035	A02-35096	V05-T1534	

Lieferung ohne Schlüssel
 Delivery without key

● Verfügbar ab Lager Available from stock
 ○ Auf Anfrage On request

S-Klemmhalter Innenbearbeitung
Tool holders type S, internal machining



Bestellbezeichnung Ordering Code	Ident No.	d	h ₁	l ₁	l ₂	f	f ₁	D _{min}	Verfügbarkeit Availability	Passende Wende- platten Suitable inserts	Seite Page	
	A0408F-SDUCR 04	5140205	8	7	80	15	3	1,5	5,6	○	DC.. 04..	41-43
	A0408F-SDUCL 04	5140207	8	7	80	15	3	1,5	5,6	○	DC.. 07..	41-43
	A0810H-SDUCR 07	5111990	10	9	100	22,5	6,5	4,4	12,5	●		
	A0810H-SDUCL 07	5111992	10	9	100	22,5	6,5	4,4	12,5	●		
	A1012K-SDUCR 07	5111993	12	11	125	27,5	9	5,9	15,5	●		
	A1012K-SDUCL 07	5111994	12	11	125	27,5	9	5,9	15,5	●		
	A1216M-SDUCR 07	5111995	16	15	150	40,5	11	4,9	18	●		
	A1216M-SDUCL 07	5111996	16	15	150	40,5	11	4,9	18	●		
	E0408F-SDUCR 04	5140208	8	7	80	15	3	1,5	5,6	○	DC.. 04..	41-43
	E0408F-SDUCL 04	5140209	8	7	80	15	3	1,5	5,6	○		

A = Stahlschaft mit Kühlbohrung Steel shank with coolant hole
 S = Stahlschaft Steel shank
 E = Hartmetall-Schaft mit Stahlkopf und Kühlbohrung
 Carbide shank with steel head and coolant hole

Rechtsausführung wie gezeichnet, Linksausführung spiegelbildlich
 Righthand version as shown, lefthand version mirrorlike

Ersatzteile Spare parts SDUCR/L		Bestellbezeichnung Ordering Code				
Schneid- kantenlänge Cutting edge length	Schaftdurch- messer Ø d Shank diameter Ø d	Unterlage Shim	Gewindehülse Shim screw	Klemm- schraube Fixation screw	Schlüssel Key	
07	12-20	-	-	A02-25059	V02-T0800	
11	20	-	-	A02-35072	V02-T1500	
11	25-40	B09-D1131	E09-F5035	A02-35096	V05-T1534	

Bestellbeispiel: 1 Stück A0408F-SDUCR 04
 Order example: 1 piece A0408F-SDUCR 04

Lieferung ohne Schlüssel
 Delivery without key

● Verfügbar ab Lager Available from stock
 ○ Auf Anfrage On request

S-Klemmhalter Innenbearbeitung
Tool holders type S, internal machining



	Bestellbezeichnung Ordering Code	Ident No.	d	h ₁	l ₁	l ₂	f	D _{min}	Verfügbarkeit Availability	Passende Wende- platten Suitable inserts	Seite Page
	A10H-SDUCR 07	5112093	10	9	100	15	7	13,5	●	DC.. 07..	41-43
	A10H-SDUCL 07	5112094	10	9	100	15	7	13,5	●		
	A12K-SDUCR 07	6401364	12	11,5	125	12,5	9	17	●		
	A12K-SDUCL 07	6401363	12	11,5	125	12,5	9	17	●		
	A12L-SDUCR 07	5112095	12	11	140	20	9	16	○		
	A12L-SDUCL 07	5112096	12	11	140	20	9	16	○		
	A16M-SDUCR 07	6401414	16	15,5	150	16,5	11	21	●		
	A16M-SDUCL 07	6401413	16	15,5	150	16,5	11	21	●		
	A16Q-SDUCR 07	5112097	16	15	180	25	11	21	○		
	A16Q-SDUCL 07	5112099	16	15	180	25	11	21	○		
	A20Q-SDUCR 07	6401461	20	19	180	20,5	13	25	●		
	A20Q-SDUCL 07	6401459	20	19	180	20,5	13	25	●		
	A20Q-SDUCR 11	6401462	20	19	180	21	13	25	●	DC.. 11..	
	A20Q-SDUCL 11	6401460	20	19	180	21	13	25	●		
	A20R-SDUCR 11	5112100	20	19	200	20,5	13	25			
	A20R-SDUCL 11	5112101	20	19	200	20,5	13	25			
	A25R-SDUCR 11	6401502	25	24	200	26	17	31,5	●		
	A25R-SDUCL 11	6401501	25	24	200	26	17	31,5	●		
	A32S-SDUCR 11	6401573	32	31	250	50	22	40	●		
	A32S-SDUCL 11	6401572	32	31	250	50	22	40	●		
	A40T-SDUCR 11	6401612	40	38,5	300	33	27	49	●		
	A40T-SDUCL 11	6401611	40	38,5	300	33	27	49	●		
	E10K-SDUCR 07	5119328	10	9	125	10	7,5	13,5	●	DC.. 07..	
	E10K-SDUCL 07	5119379	10	9	125	10	7,5	13,5	●		
	E12M-SDUCR 07	5119380	12	11	150	12,5	9	15	●		
	E12M-SDUCL 07	5119382	12	11	150	12,5	9	15	●		
	E12Q-SDUCR 07	6404776	12	11,5	180	12,5	9	17	●		
	E12Q-SDUCL 07	6404775	12	11,5	180	12,5	9	17	●		
	E16R-SDUCR 07	6404804	16	15,5	200	16,5	11	21	●		
	E16R-SDUCL 07	6404803	16	15,5	200	16,5	11	21	●		
	E20S-SDUCR 11	6404856	20	19	250	20,5	13	25	●	DC.. 11..	
	E20S-SDUCL 11	6404855	20	19	250	20,5	13	25	●		
E25T-SDUCR 11	6404888	25	24	300	26	17	31,5	●			
E25T-SDUCL 11	6404887	25	24	300	26	17	31,5	●			
S12Q-SDUCR 07	6407209	12	11	180	12,5	9	17	●	DC.. 07..		
S12Q-SDUCL 07	6407208	12	11	180	12,5	9	17	●			
S16R-SDUCR 07	6407215	16	15	200	16,5	11	21	●			
S16R-SDUCL 07	6407214	16	15	200	16,5	11	21	●			
S20S-SDUCR 07	6407232	20	18	250	20,5	13	25	●			
S20S-SDUCL 07	6407230	20	18	250	20,5	13	25	○			
S20S-SDUCR 11	6407233	20	18	250	20,5	13	25	●	DC.. 11..		
S20S-SDUCL 11	6407231	20	18	250	20,5	13	25	●			
S25T-SDUCR 11	6407260	25	23	300	26	17	31,5	●			
S25T-SDUCL 11	6407259	25	23	300	26	17	31,5	●			
S32U-SDUCR 11	6407289	32	30	350	33	22	40	●			
S32U-SDUCL 11	6407288	32	30	350	33	22	40	○			

Ersatzteile Spare parts		Bestellbezeichnung Ordering Code				
SDUCR/L						
Schneid- kantenlänge Cutting edge length	Schaftdurch- messer Ø d Shank diameter Ø d	Unterlage Shim	Gewindehülse Shim screw	Klemm- schraube Fixation screw	Schlüssel Key	
07	12-20	-	-	A02-25059	V02-T0800	
11	20	-	-	A02-35072	V02-T1500	
11	25-40	B09-D1131	E09-F5035	A02-35096	V05-T1534	

Bestellbeispiel: 1 Stück A10H-SDUCR 07
 Order example: 1 piece A10H-SDUCR 07

Lieferung ohne Schlüssel
 Delivery without key

● Verfügbar ab Lager Available from stock
 ○ Auf Anfrage On request

S-Klemmhalter Innenbearbeitung
Tool holders type S, internal machining



		Bestellbezeichnung Ordering Code	Ident No.	d	h ₁	l ₁	l ₂	f	D _{min}	Verfügbarkeit Availability	Passende Wendeplatten Suitable inserts	Seite Page
STFC-R/L 		A12K-STFCR 11	6401366	12	11,5	125	13	9	17	●	TC.. 11..	53-54
		A12K-STFCL 11	6401365	12	11,5	125	13	9	17	●		
		A16M-STFCR 11	6401416	16	15,5	150	13	11	21	●		
		A16M-STFCL 11	6401415	16	15,5	150	13	11	21	●		
		A20Q-STFCR 11	6401464	20	19	180	13	13	25	●		
		A20Q-STFCL 11	6401463	20	19	180	13	13	25	●		
		A25R-STFCR 16	6401504	25	24	200	21	17	31,5	●	TC.. 16..	53-54
		A25R-STFCL 16	6401503	25	24	200	21	17	31,5	○		
		A32S-STFCR 16	6401575	32	31	250	21	22	40	●		
		A32S-STFCL 16	6401574	32	31	250	21	22	40	○		
		A40T-STFCR 16	6401614	40	38,5	300	21	27	49	○		
		A40T-STFCL 16	6401613	40	38,5	300	21	27	49	○		
		S12Q-STFCR 11	6407211	12	11	180	13	9	17	●	TC.. 11..	53-54
		S12Q-STFCL 11	6407210	12	11	180	13	9	17	○		
		S20S-STFCR 11	6407235	20	18	250	13	13	25	●		
		S20S-STFCL 11	6407234	20	18	250	13	13	25	●		
		S16R-STFCR 11	6407217	16	15,5	150	13	11	21	●	TC.. 16..	53-54
		S16R-STFCL 11	6407216	16	15,5	150	13	11	21	●		
		S25T-STFCR 16	6407262	25	23	300	21	17	31,5	●		
		S25T-STFCL 16	6407261	25	23	300	21	17	31,5	○		
	S32U-STFCR 16	6407291	32	30	350	21	22	40	●			
	S32U-STFCL 16	6407290	32	30	350	21	22	40	○			
	S40V-STFCR 16	6407318	40	37	400	21	27	49	●			
	S40V-STFCL 16	6407317	40	37	400	21	27	49	○			
SVLC-R/L 		A08F-SVLCR 05	5119398	7	80	15	5	-	9,2	●	VC.. 05..	57
		A08F-SVLCL 05	5119399	7	80	26	5	-	9,2	●		
		A10H-SVLCR 07	6437515	10	-	100	22	7	12,5	●	VC.. 07..	57
		A10H-SVLCL 07	6426806	10	-	100	22	7	12,5	●		
		A12K-SVLCR 07	6437519	12	-	125	28	9	15,5	○		
		A12K-SVLCL 07	6437518	12	-	125	28	9	15,5	●		
		A16M-SVLCR 07	6437523	16	-	150	36	11	19,5	○		
		A16M-SVLCL 07	6437522	16	-	150	36	11	19,5	○		
		E08F-SVLCR 05	5119400	7	80	26	5	-	9,2	●	VC.. 05..	57
		E08F-SVLCL 05	5119401	7	80	26	5	-	9,2	●		
SVOC-R/L 		A08F-SVOCR 05	5119385	8	7	80	15	3	9	●	VC.. 05..	57
		A08F-SVOCL 05	5119386	8	7	80	15	3	9	●		
		A10H-SVOCR 07	6437517	10	9	100	-	5,4	11	●	VC.. 07..	57
		A10H-SVOCL 07	6437516	10	9	100	-	5,4	11	●		
		A10K-SVOCR 07	5112102	10	9	125	18	1,5	13	●		
		A10K-SVOCL 07	5112103	10	9	125	18	1,5	13	●		
		A12K-SVOCR 07	6437521	12	11	125	-	5,4	11	●		
		A12K-SVOCL 07	6437520	12	11	125	-	5,4	11	●		
		A12L-SVOCR 07	5112104	12	11	140	18	2	13	●		
		A12L-SVOCL 07	5112105	12	11	140	18	2	13	●		
		A16M-SVOCR 11	6437525	16	15	150	16	11	20	●	VC.. 11..	57
		A16M-SVOCL 11	6437524	16	15	150	16	11	20	●		
		E08F-SVOCR 05	5119387	8	7	80	15	3	9	●	VC..05..	57
		E08F-SVOCL 05	5119388	8	7	80	15	3	9	●		

Ersatzteile Spare parts			Bestellbezeichnung Ordering Code			
STFCR/L						
Schneidkantenlänge Cutting edge length	Wendeplatte Indexable insert	Schaftdurchmesser Ø d Shank diameter Ø d	Unterlage Shim	Gewindehülse Shim screw	Klemmschraube Fixation screw	Schlüssel Key
11	VC...	16-25	-	-	A02-25059	V02-T0800
16	VC...	32-40	B09-V1602	E09-F5035	A02-35096	V05-T1534

Bestellbeispiel: 1 Stück A12K-STFCR 11
 Order example: 1 piece A12K-STFCR 11

● Verfügbar ab Lager Available from stock
 ○ Auf Anfrage On request

S-Klemmhalter Innenbearbeitung

Tool holders type S, internal machining



		Bestellbezeichnung Ordering Code		Ident No.	d	h ₁	l ₁	l ₂	f	D _{min}	Verfügbarkeit Availability	Passende Wendeplatten Suitable inserts	Seite Page	
	SVQC-R/L	A16M-SVQCR 11	6401418	16	15,5	150	16,5	11	21	●	VC.. 11..	56-57		
		A16M-SVQCL 11	6401417	16	15,5	150	16,5	11	21	●				
		A20Q-SVQCR 11	6401466	20	19	180	20,5	13	25	●				
		A20Q-SVQCL 11	6401465	20	19	180	20,5	13	25	●				
		A25R-SVQCR 11	6401506	25	24	200	25,5	17	31,5	●				
			A25R-SVQCL 11	6401505	25	24	200	25,5	17	31,5	●	VC.. 16..	56-58	
			A32S-SVQCR 16	6401577	32	31	250	33,5	22	40	●			
			A32S-SVQCL 16	6401576	32	31	250	33,5	22	40	●			
			A40T-SVQCR 16	6401616	40	38,5	300	40	27	49	●			
			A40T-SVQCL 16	6401615	40	38,5	300	40	27	49	●			
	SVUB-R/L	S32T-SVUBR 16	6407276	32	30	300	60	22	40	●	VB.. 16..	56		
		S32T-SVUBL 16	6407275	32	30	300	60	22	40	●				
	SVUC-R/L	A16M-SVUCR 11	6401420	16	15,5	150	16,5	11	21	●	VC.. 11..	56-57		
			A16M-SVUCL 11	6401419	16	15,5	150	16,5	11	21			●	
			A20Q-SVUCR 11	6401468	20	19	180	20,5	13	25			●	
			A20Q-SVUCL 11	6401467	20	19	180	20,5	13	25			●	
			A25R-SVUCR 11	6401508	25	24	200	25,5	17	31,5			●	
				A25R-SVUCL 11	6401507	25	24	200	25,5	17	31,5	●	VC.. 16..	56-58
				A32S-SVUCR 16	6401579	32	31	250	33,5	22	40	●		
				A32S-SVUCL 16	6401578	32	31	250	33,5	22	40	●		
				A40T-SVUCR 16	6401618	40	38,5	300	40	27	49	●		
			A40T-SVUCL 16	6401617	40	38,5	300	40	27	49	●			
			E16R-SVUCR 11	6404806	16	15,5	200	16,5	11	21	●	VC.. 11..	56-57	
			E16R-SVUCL 11	6404805	16	15,5	200	16,5	11	21	○			
			E20S-SVUCR 11	6404858	20	19	250	20,5	13	25	●			
		E20S-SVUCL 11	6404857	20	19	250	20,5	13	25	○				
		E25T-SVUCR 11	6404890	25	24	300	25,5	17	31,5	○				
		E25T-SVUCL 11	6404889	25	24	300	25,5	17	31,5	○				

A = Stahlschaft mit Kühlbohrung Steel shank with coolant hole
 S = Stahlschaft Steel shank
 E = Hartmetall-Schaft mit Stahlkopf und Kühlbohrung
 Carbide shank with steel head and coolant hole

Rechtsausführung wie gezeichnet, Linksausführung spiegelbildlich
 Righthand version as shown, lefthand version mirrorlike

Ersatzteile Spare parts			Bestellbezeichnung Ordering Code			
SV.CR/L						
Schneidkantenlänge Cutting edge length	Wendeplatte Indexable insert	Schaftdurchmesser Ø d Shank diameter Ø d	Unterlage Shim	Gewindehülse Shim screw	Klemmschraube Fixation screw	Schlüssel Key
07	VC...	10 -16			A13-20048	V04-T0600
11	VC...	16 -25	-	-	A02-25059	V02-T0800
16	VC...	32 -40	B09-V1602	E09-F5035	A02-35096	V05-T1534
r = 0,4 -0,8	VB...	32	B02-V1431	E02-F5035	A02-35096	V05-T1534
16	VC...	32 -40	B09-V1606	E09-F5035	A02-35096	V05-T1534
r = 1,2	VB...	32	B02-V1431	E02-F5035	A02-35096	V05-T1534





Bestellbeispiel: 1 Stück A16M-SVQCR 11
 Order example: 1 piece A16M-SVQCR 11

Lieferung ohne Schlüssel
 Delivery without key

● Verfügbar ab Lager Available from stock
 ○ Auf Anfrage On request

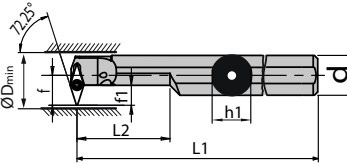
S-Klemmhalter Innenbearbeitung
Tool holders type S, internal machining

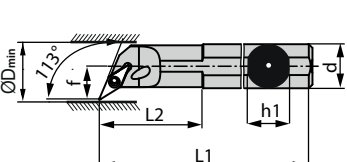

	Bestellbezeichnung Ordering Code	Ident No.	d	h ₁	l ₁	l ₂	f	f ₁	D _{min}	Verfügbarkeit Availability	Passende Wendeplatten Suitable inserts	Seite Page	
<p>SVVCR/L</p>   	A08F-SVVCR 05	5119402	8	7	80	15	5	-	9,7	●	VC..05..	57	
	A08F-SVVCL 05	5119403	8	7	80	15	5	-	9,7	●			
	E08F-SVVCR 05	5119404	8	7	80	26	5	-	9,7	●			
	E08F-SVVCL 05	5119405	8	7	80	26	5	-	9,7	●			
	A10H-SVVCR 07	5112111	10	9	100	28	8	6	13,5	●	VC..07..	57	
	A10H-SVVCL 07	5112114	10	9	100	28	8	6	13,5	●			
	A12K-SVVCR 07	5112117	12	11	125	28	9	6	15,5	●			
	A12K-SVVCL 07	5112118	12	11	125	28	9	6	15,5	●			
	A16M-SVVCR 07	5112119	16	15	150	36	11	6	19,5	●			
	A16M-SVVCL 07	5112137	16	15	150	36	11	6	19,5	●			
	A16M-SVVCR 11	5112138	16	15	150	40	13,9	9,5	23	●	VC.. 11..	56-57	
	A16M-SVVCL 11	5112140	16	15	150	40	13,9	9,5	23	●			
	E10H-SVVCR 07	5120810	10	9	100	32	6	-	13,5	●	VC..07..	57	
	E10H-SVVCL 07	5120809	10	9	100	32	6	-	13,5	●			
	E12K-SVVCR 07	5120816	12	11	125	40	6	-	15,5	●			
	E12K-SVVCL 07	5120815	12	11	125	40	6	-	15,5	●			
	E16M-SVVCR 11	5120824	16	15	150	55	6	-	19,5	●	VC.. 11..	56-57	
	E16M-SVVCL 11	5120823	16	15	150	55	6	-	19,5	●			
	<p>SVXCR/L</p>   	A08F-SVXCR 05	5119393	8	7	80	15	5	-	9,2	●	VC..05..	57
		A08F-SVXCL 05	5119395	8	7	80	15	5	-	9,2	●		
A10H-SVXCR 07		5112141	10	9	100	22	7	-	12,5	●	VC..07..	57	
A10H-SVXCL 07		5112142	10	9	100	22	7	-	12,5	●			
A12K-SVXCR 07		5112143	12	11	125	28	9	-	15,5	●			
A12K-SVXCL 07		5112144	12	11	125	28	9	-	15,5	●			
A16M-SVXCR 07		5112145	16	15	150	36	11	-	19,5	●			
A16M-SVXCL 07		5112146	16	15	150	36	11	-	19,5	●			
E08F-SVXCR 05		5119396	8	7	80	26	5	-	9,2	●	VC..05..	57	
E08F-SVXCL 05		5119397	8	7	80	26	5	-	9,2	●			
E10H-SVXCR 07		5120812	10	9	100	22	7	-	12,5	●	VC..07..	57	
E10H-SVXCL 07		5120811	10	9	100	22	7	-	12,5	●			
E12K-SVXCR 07		5120818	12	11	125	40	9	-	15,5	●			
E12K-SVXCL 07		5120817	12	11	125	40	9	-	15,5	●			
E16M-SVXCR 07		5120826	16	15	150	55	11	-	19,5	●			
E16M-SVXCL 07		5120825	16	15	150	55	11	-	19,5	●			

Bestellbeispiel: 1 Stück A08F-SVVCR 05
 Order example: 1 piece A08F-SVVCR 05

Ersatzteile Spare parts SV.CR/L		Bestellbezeichnung Ordering Code				
Schneidkantenlänge Cutting edge length	Schaftdurchmesser Ø d Shank diameter Ø d	 Unterlage Shim	 Gewindehülse Shim screw	 Klemmschraube Fixation screw	 Schlüssel Key	
05	08			A02-15045	V02 T0500	
07	10 - 16			A13-20048	V04 T0600	
11	16			A02-25059	V02 T0800	

● Verfügbar ab Lager Available from stock
 ○ Auf Anfrage On request

S-Klemmhalter Innenbearbeitung
Tool holders type S, internal machining



Bestellbezeichnung Ordering Code	Ident No.	d	h ₁	l ₁	l ₂	f	D _{min}	Verfügbarkeit Availability	Passende Wende- platten Suitable inserts	Seite Page
SV95CR/L										
A08F-SV95CR 05	5119406	8	7	85	15	-	9,2	●	VC.. 05..	57
A08F-SV95CL 05	5119407	8	7	85	15	-	9,2	●		
E08F-SV95CR 05	5119408	8	7	85	26	-	9,2	●		
E08F-SV95CL 05	5119409	8	7	85	26	-	9,2	●		
A10H-SV95CR 07	5112147	10	9	100	22	7	12,5	●	VC.. 07..	57
A10H-SV95CL 07	5112148	10	9	100	22	7	12,5	●		
A12K-SV95CR 07	5112149	12	11	125	28	9	15,5	●		
A12K-SV95CL 07	5112150	12	11	125	28	9	15,5	●		
A16M-SV95CR 07	5112151	16	15	150	36	11	19,5	●		
A16M-SV95CL 07	5112152	16	15	150	36	11	19,5	●		
E10H-SV95CR 07	5120808	10	9	100	32	5	12,5	●		
E10H-SV95CL 07	5120807	10	9	100	32	5	12,5	●		
E12K-SV95CR 07	5120814	12	11	125	40	6	15,5	●		
E12K-SV95CL 07	5120813	12	11	125	40	6	15,5	●		
E16M-SV95CR 07	5120821	16	15	150	55	8	19,5	●		
E16M-SV95CL 07	5120819	16	15	150	55	8	19,5	●		

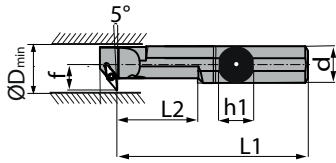

Bestellbeispiel: 1 Stück A08F-SV95CR 05
 Order example: 1 piece A08F-SV95CR 05

Ersatzteile Spare parts SV.CR/L		Bestellbezeichnung Ordering Code					
Schneid- kantenlänge Cutting edge length	Schaftdurch- messer Ø d Shank diameter Ø d	Unterlage Shim	Gewindehülse Shim screw	Klemm- schraube Fixation screw	Schlüssel Key		
05	08			A02-15045	V02 T0500		
07	10 - 16			A13-20048	V04 T0600		
11	16			A02-25059	V02 T0800		

- Verfügbar ab Lager Available from stock
- Auf Anfrage On request

S-Klemmhalter Innenbearbeitung
Tool holders type S, internal machining



	Bestellbezeichnung Ordering Code	Ident No.	d	h ₁	l ₁	l ₂	f	D _{min}	Verfügbarkeit Availability	Passende Wende- platten Suitable inserts	Seite Page			
	A16M-SWLCR 06	6401422	16	15,5	150	-	11	21	●	WC.. 06..	59			
	A16M-SWLCL 06	6401421	16	15,5	150	-	11	21	○					
	E16R-SWLCR 06	6404808	16	15	200	-	11	21	○					
	E16R-SWLCL 06	6404807	16	15	200	-	11	21	○					
	S16R-SWLCR 06	6407223	16	15	200	-	11	21	●					
	S16R-SWLCL 06	6407222	16	15	200	-	11	21	●					
	A20Q-SWLCR 06	6401470	20	19	180	-	13	25	○					
	A20Q-SWLCL 06	6401469	20	19	180	-	13	25	●					
	E20S-SWLCR 06	6404860	20	19	250	-	13	25	○					
	E20S-SWLCL 06	6404859	20	19	250	-	13	25	○					
	S20S-SWLCR 06	6407241	20	18	250	-	13	25	○					
	S20S-SWLCL 06	6407240	20	18	250	-	13	25	○					
	A25R-SWLCR 06	6401510	25	24	200	-	17	31,5	○					
	A25R-SWLCL 06	6401509	25	24	200	-	17	31,5	○					
	E25T-SWLCR 06	6404892	25	24	300	-	17	31,5	○					
	E25T-SWLCL 06	6404891	25	24	300	-	17	31,5	○					
	S25T-SWLCR 06	6407268	25	23	300	-	17	31,5	○					
	S25T-SWLCL 06	6407267	25	23	300	-	17	31,5	○					
													WC.. 08..	59
	A32S-SWLCR 08	6401581	32	31	250	-	22	40	○					
	A32S-SWLCL 08	6401580	32	31	250	-	22	40	○					
	S32U-SWLCR 08	6407297	32	30	350	-	22	40	○					
	S32U-SWLCL 08	6407296	32	30	350	-	22	40	○					
	A40T-SWLCR 08	6401620	40	38,5	300	-	27	49	○					
	A40T-SWLCL 08	6401619	40	38,5	300	-	27	49	○					
	S40V-SWLCR 08	6407324	40	37	400	-	27	49	○					
	S40V-SWLCL 08	6407323	40	37	400	-	27	49	○					

A = Stahlschaft mit Kühlbohrung Steel shank with coolant hole
 S = Stahlschaft Steel shank
 E = Hartmetall-Schaft mit Stahlkopf und Kühlbohrung
 Carbide shank with steel head and coolant hole

Rechtsausführung wie gezeichnet, Linksausführung spiegelbildlich
 Righthand version as shown, lefthand version mirrorlike

Ersatzteile Spare parts		Bestellbezeichnung Ordering Code				
Schneid- kantenlänge Cutting edge length	Schaftdurch- messer Ø d Shank diameter Ø d	Unterlage Shim	Gewindehülse Shim screw	Klemm- schraube Fixation screw	Schlüssel Key	
06	16-25	-	-	A02-35082	V02-T1500	
08	32-40	B09-W0831	E09-F6045	A02-45102	V05-T1534	

Bestellbeispiel: 1 Stück A16M-SWLCR 06
 Order example: 1 piece A16M-SWLCR 06

Lieferung ohne Schlüssel
 Delivery without key

C-Klemmhalter Innenbearbeitung
Tool holders type C, internal machining



	Bestellbezeichnung Ordering Code	Ident No.	d	h ₁	l ₁	l ₂	f	D _{min}	Verfügbarkeit Availability	Passende Wende- platten Suitable inserts	Seite Page	
	S74 P16R-TP11	6407343	16	14	180	14	10,7	20	●	TPMR 11..	55	
	S74 P16L-TP11	6407342	16	14	180	14	10,7	20	●			
	S74 P20R-TP11	6407345	20	18	250	14	13,8	27	●			
		S74 P20L-TP11	6407344	20	18	250	14	13,8	27	●		
		S74 P25R-TP16	6407347	25	23	300	20	17,7	34	●	TPMR 16..	55
		S74 P25L-TP16	6407346	25	23	300	20	17,7	34	●		
		S74 P32R-TP16	6407349	32	30	350	20	22,2	43	●		
		S74 P32L-TP16	6407348	32	30	350	20	22,2	43	●		
		S74 P40R-TP16	6407350	40	37	350	20	27,7	58	●		

S = Stahlschaft Steel shank

Rechtsausführung wie gezeichnet, Linksausführung spiegelbildlich
 Righthand version as shown, lefthand version mirrorlike

Ersatzteile Spare parts		Bestellbezeichnung Ordering Code					
Schneid- kantenlänge Cutting edge length	Schaftdurch- messer Ø d Shank diameter Ø d						
		Unterlage Shim	Rohrstift Shim pin	Klemmfinger Clamp	Schlüssel Key		
11	16-20	-	-	33.01.05	V02-T1000		
16	25-40	33.03.04	33.04.04	33.01.06	V02-T2000		

Bestellbeispiel: 1 Stück S74P-16R TP 11
 Order example: 1 piece S74P-16R TP11

Lieferung ohne Schlüssel
 Delivery without key

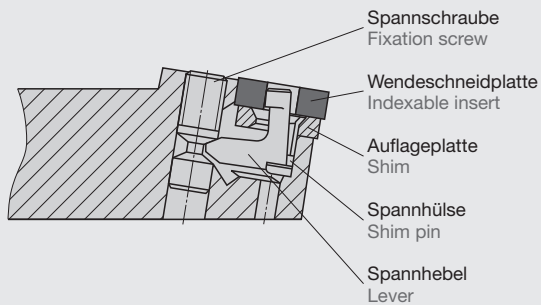

P-Hebelspannsystem

- Geeignet für alle Wendeschneidplatten nach DIN 4988
- Wenig Ersatzteile, keine losen Teile
- Ungehinderter Spanablauf, da kein störender Aufbau
- Einwandfreies Lösen der Schneidplatte durch Zwangsentspannen
- Schnelles, sicheres Spannen der Wendeschneidplatte

P-lever clamping system

- Suitable for all indexable inserts in compliance with DIN 4988
- Few spare parts, no loose parts
- Unimpeded chip removal as there is no troublesome build-up
- Perfect insert removal thanks to forced release mechanism
- Fast and secure clamping of indexable insert

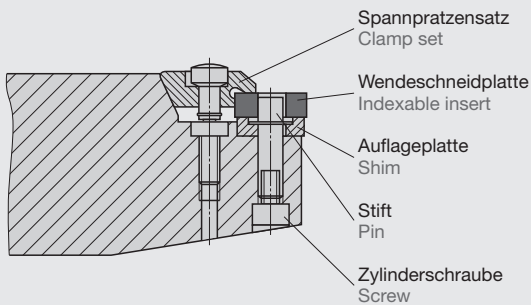

M bzw. D-Keilspannpratzensystem

- Schnelles, sicheres Spannen durch Keil- und Spannpratze
- Schneidplatte ist an Haupt- und Nebenschneide frei
- Vorteilhaft vor allem bei Kopierarbeiten
- Besonders ausgebildeter Spannkeil bringt optimalen Spanfluss

M- or D-wedge clamp system

- Fast and secure clamping using wedges and clamps
- Insert is free around the primary and secondary cutting edges
- Especially well-suited to copy machining
- Specially shaped clamping wedge provides ideal chip flow

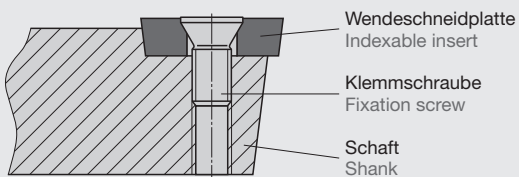





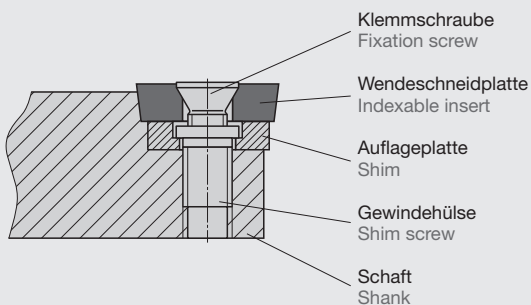

S-Schraubspannsystem







- Einfache und sichere Befestigung der Schneidplatte durch kegelige Positionierungsschraube
- Keine Beeinträchtigung des Spanablaufes
- Maximal 3 Ersatzteile

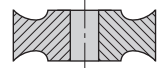
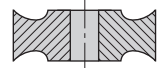



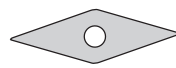

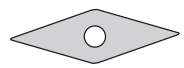

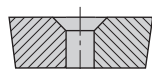



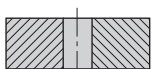

S-screw clamp system

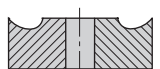
- Simple and secure fixing of the indexable insert using a tapered positioning screw
- Flow of chips is not obstructed
- Maximum of 3 replacement parts

P-Klemmhalter P-type tool holders 	Bearbeitungsart Process type	Außen External	Innen Internal
	Schruppen Roughing	sehr gut very good	sehr gut very good
	Schlichten Finishing	gut good	gut good
	Plattenform Shape of the indexable insert	  	 
Plattentyp Type of the indexable insert	  		

S-Klemmhalter S-type tool holders 	Bearbeitungsart Process type	Außen External	Innen Internal
	Schruppen Roughing	geeignet suitable	geeignet suitable
	Schlichten Finishing	sehr gut very good	sehr gut very good
	Plattenform Shape of the indexable insert	    	
Plattentyp Type of the indexable insert	 		

M-Klemmhalter M-type tool holders 	Bearbeitungsart Process type	Außen External	Innen Internal
	Schruppen Roughing	geeignet suitable	geeignet suitable
	Schlichten Finishing	gut good	sehr gut very good
	Plattenform Shape of the indexable insert	  	
Plattentyp Type of the indexable insert	  		

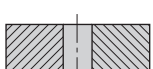
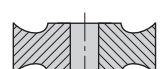
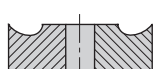
D-Klemmhalter D-type tool holders 	Bearbeitungsart Process type	Außen External	Innen Internal
	Schruppen Roughing	geeignet suitable	geeignet suitable
	Schlichten Finishing	gut good	sehr gut very good
	Plattenform Shape of the indexable insert	  	
Plattentyp Type of the indexable insert	  		

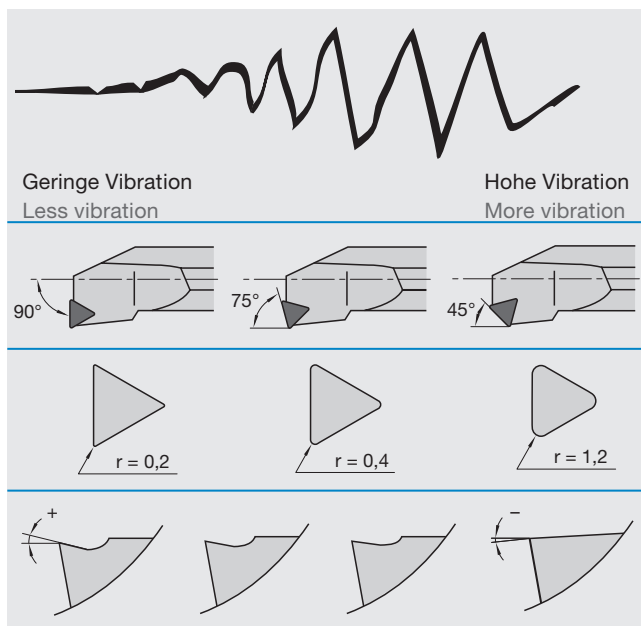
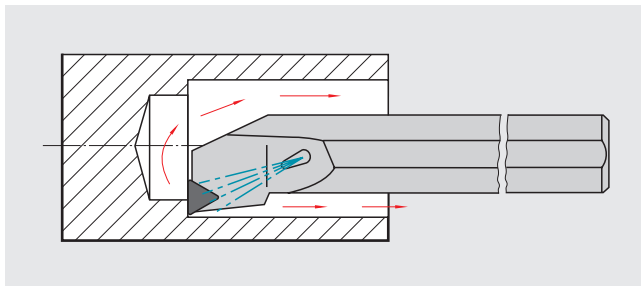
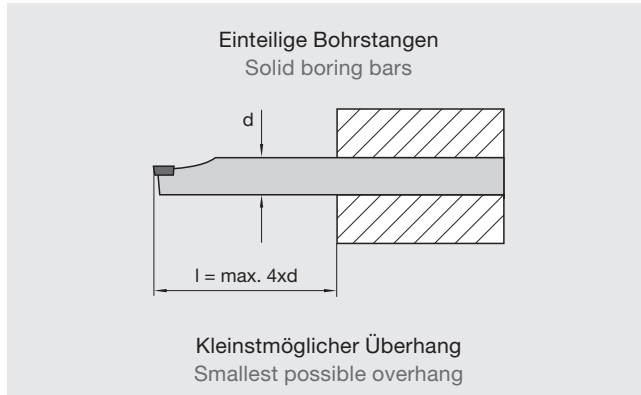

Allgemeine Empfehlungen

- Den größtmöglichen Schaftdurchmesser wählen.
- Kleinstmöglichen Überhang wählen.
- Korrekte und stabile Einspannung für die Bohrstange wählen.
- Kühlschmierstoff (oder Druckluft) können den Spantransport und die Oberflächengüte, besonders bei tiefen Bohrungen, verbessern.

General recommendations

- Use the largest possible shank diameter.
- Use the smallest possible overhang.
- Use the correct, stable clamping method for the boring bar.
- Cooling lubricant (or compressed air) can improve chip transport and the surface quality, particularly with deep bores.

Faktoren, die bei der Wahl der Bohrstanen für vibrationsanfällige Bearbeitungen eine Rolle spielen

- Der Einstellwinkel sollte so nahe wie möglich an 90° und nicht unter 75° liegen.
- Kleinen Eckenradius wählen.
- Positive Halter (S-Klemmhalter) und Wendeschneidplatten wählen.
- Unbeschichtete Sorten haben in der Regel schärfere Schneidkanten und erzeugen daher geringere Schnittkräfte.

Factors to consider when selecting boring bars for work susceptible to vibration:

- The approach angle should be as close as possible to 90° and not be below 75°.
- Select a small corner radius.
- Use positive holders (S-clamp holder) and indexable inserts.
- Uncoated grades generally have sharper cutting edges and therefore generate less cutting force.

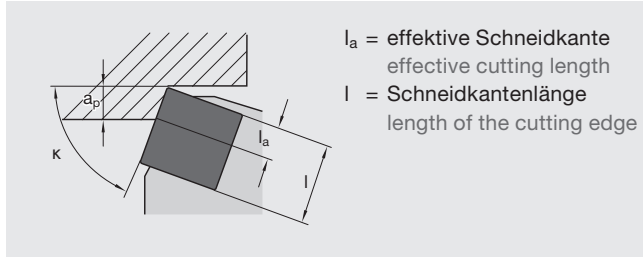

Spantiefe

- Bestimmen der größten Spantiefe a_p .
- Erforderliche effektive Schneidkantenlänge l_a bestimmen. Dabei sind der Anstellwinkel κ und die Spantiefe a_p zu berücksichtigen.
- Die kleinste erforderliche Schneidkantenlänge l_a kann aus der Tabelle links abgelesen werden.

Depth of cut

- Determine the largest depth of cut a_p .
- Determine the effective length of cutting edge (l_a) required. The setting angle (κ) and the depth of cut (a_p) should be taken into consideration.
- The smallest length of cutting edge (l_a) required can be found in the table to the left.

Anstellwinkel Angle of approach κ	Spantiefe (a_p) mm Depth of cut (a_p) mm										
	1	2	3	4	5	6	7	8	9	10	15
	Erforderliche effektive Schneidkantenlänge (l_a) mm Required effective length of the cutting edge (l_a) mm										
90	1	2	3	4	5	6	7	8	9	10	15
105 75	1,1	2,1	3,1	4,1	5,2	6,2	7,3	8,3	9,3	11	16
120 60	1,2	2,3	3,5	4,7	5,8	7	8,2	9,3	11	12	18
135 45	1,4	2,9	4,3	5,7	7,1	8,5	10	12	13	15	22
150 30	2	4	6	8	10	12	14	16	18	20	30
165 15	4	8	12	16	20	24	27	31	35	39	58

Effektive Schneidkantenlänge

Der Spitzenwinkel einer Wendschneidplatte hat einen großen Einfluss auf die Schneidkantenstabilität. Jede Wendschneidplatte hat eine maximale effektive Schneidkantenlänge. Die in der Tabelle angeführten maximalen Werte sind für eine Bearbeitungssicherheit beim Schruppen ohne unterbrochenen Schnitt ausgelegt.

Falls die effektive Schneidkantenlänge niedriger als die Spantiefe ist, sollte eine größere Wendeplatte gewählt oder die Spantiefe reduziert werden.

Für zusätzliche Sicherheit bei anspruchsvollen Zerspanaufgaben sollte eine größere und dickere Wendschneidplatte eingesetzt werden. Beim Drehen gegen eine Schulter kann sich die Spantiefe erheblich erhöhen. Damit es hier nicht zu Problemen kommt, sollte eine größere Wendschneidplatte verwendet oder eine zusätzliche Plandrehoperation durchgeführt werden.

The effective length of the cutting edge

The point angle of an indexable insert has a great influence on the stability of the cutting edges. Every indexable insert has a maximum effective cutting edge length. The maximum values given in the table are designed for working safety when rough cutting with a continuous cut.

If the effective length of the cutting edges is lower than the depth of cut, a larger indexable insert should be used or the depth of cut should be reduced.

For additional safety during difficult cutting jobs, a larger or thicker indexable insert should be used. When turning against a shoulder, the depth of cut can be increased considerably. So that no problems arise here, a larger indexable insert should be used or an additional face turning operation should be performed.

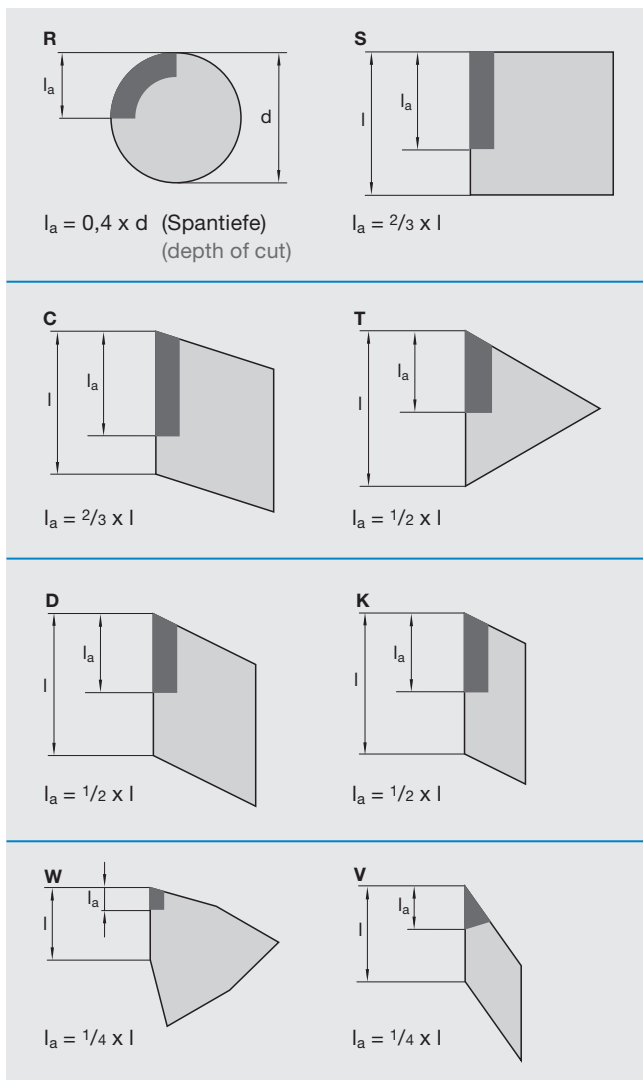

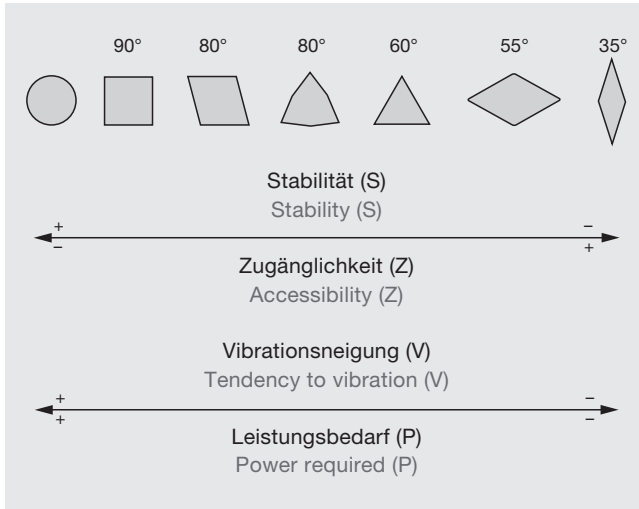

Wendeplattenform

Die Abbildung zeigt die gebräuchlichsten ISO-Plattenformen von der runden bis hin zur 35° Wendeschneidplatte.

Die Pfeilskala zeigt, dass die Schneidkantenstabilität (S) mit größer werdendem Eckenwinkel zunimmt. Je kleiner der Eckenwinkel, umso besser ist die Zugänglichkeit (Z).

Die Pfeilskala zeigt, dass die Vibrationsneigung (V) links ansteigt, während der Leistungsbedarf (P) rechts niedriger ist.

Beim Drehen von Formen darf beim Einwärtskopieren der maximale Kopierwinkel nicht überschritten werden. Der Winkel zwischen der Nebenschneide und der erzeugten Werkstückform sollte mindestens 2° betragen.

Indexable insert shape

The diagram shows the most common indexable insert shapes from round tips right down to 35° indexable inserts.

The arrow on the scale shows that the stability of the cutting edge (S) grows with increasing point angle, whereas the accessibility (Z) becomes improved by smaller point angles.

Tendency to vibration (V) and power requirement (P) rise with larger point angles.

When turning shapes the maximum copy angle must not be exceeded for inward copying. The angle between the secondary cutting edge and the workpiece shape produced should be at least 2°.

Eckenradius (r) mm Corner radius (r) mm	0,4	0,8	1,2	1,6	2,4
Max. empf. Vorschub (f_n) mm/U Recommended max. feed rate (f_n) mm/rev	0,25–0,35	0,4–0,7	0,5–1,0	0,7–1,3	1,0–1,8

Eckenradius und Vorschub

Der Eckenradius der Wendeschneidplatte ist ein Schlüsselfaktor in Bezug auf:

- Stabilität beim Schrappen.
- Oberflächengüte beim Schlichten.

Schruppbearbeitung

- Größtmöglichen Eckenradius wählen, um eine möglichst stabile Schneidkante zu gewährleisten.

- Ein großer Eckenradius erlaubt größere Vorschübe.
- Bei Vibrationsgefahr kleineren Eckenradius wählen.

Bei der Wahl des Vorschubs für die Schruppdrehbearbeitung dürfen die maximalen Vorschubwerte wie oben genannt auf keinen Fall überschritten werden. Als Grundregel gilt:

$$f_n \text{ Schrappen} = 0,5 \times \text{Eckenradius}$$

Maximaler Vorschub für verschiedene Eckenradien

Die bei der Schruppbearbeitung am häufigsten verwendeten Radien betragen 1,2 - 1,6 mm.

Die Tabelle basiert auf der max. empfohlenen Vorschubgeschwindigkeit von $\frac{2}{3}$ des Eckenradius.

Höhere Vorschübe sind möglich bei:

- Wendeschneidplatten mit stabiler Schneidkante und Spitzenwinkel von min. 60°.
- Einseitigen Wendeschneidplatten.
- Wendeschneidplatten, die mit einem Anstellwinkel unter 90° eingesetzt werden.
- Bearbeitungen von gut zerspanbaren Werkstückstoffen mit mittleren Schnittgeschwindigkeiten.

Corner radius and feed

The corner radius of the indexable insert is a key factor with regard to:

- Stability during rough cutting.
- Surface quality during finishing.

Roughing

- Use the largest possible corner radius to ensure the greatest degree of stability for the cutting edge.

- A large corner radius permits a greater feed rate.

- Use a smaller corner radius if there is a risk of vibration.

When selecting the feed rate for rough turning work, the maximum feed rates given above must not be exceeded in any circumstances. The basic rule is:

$$f_n \text{ Roughing} = 0,5 \times \text{Corner radius}$$

Maximum feed rate for various corner radii

The most frequently used radii for rough machining are between 1.2 - 1.6 mm.

The table is based on the max. recommended feed rate of $\frac{2}{3}$ of the corner radius.

Greater feed rates are possible in the following cases:

- Indexable inserts have a stable cutting edge and a point angle of at least 60°.
- Single-sided indexable inserts.
- Indexable inserts which are used with a setting angle less than 90°.
- Working easily machineable workpiece materials at moderate cutting speeds.

Theoretische maximale Rautiefe (R_{max})
Theoretical maximum roughness height (R_{max})

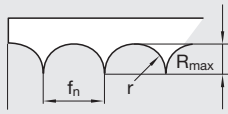

R_{max} = Rautiefe
Roughness height
 r = Eckenradius (mm)
Corner radius (mm)
 f_n = Vorschub (mm/U)
Feed (mm/revolution)

$$R_{max} = \frac{f_n^2}{8r} \cdot 1000 \text{ (}\mu\text{m)}$$

Vorschub Feed:

$$f_n = \sqrt{\frac{R_{max} \times 8r}{1000}}$$

Die Oberflächengüte und Toleranzgenauigkeit wird wesentlich durch das Zusammenspiel von Vorschub und Eckenradius beeinflusst. Weitere Einflussgrößen sind die Stabilität der Aufspannung und der Maschine.

Allgemeine Empfehlung

- Die Oberflächengüte kann durch höhere Schnittgeschwindigkeiten und positive Spanwinkel noch verbessert werden.
- Bei Vibrationsgefahr kleineren Eckenradius wählen.
- Besonders gute Oberflächengüten werden mit unbeschichteten Hartmetallsorten (schärfere Schneidkanten als beschichtete Sorten) erzielt.

The surface quality and accuracy of the tolerance is greatly influenced by the interaction of the feed rate and corner radius. The stability of the clamping system and the machine are other decisive factors.

Mittenrauwert (R_a)
Mean roughness figure (R_a)

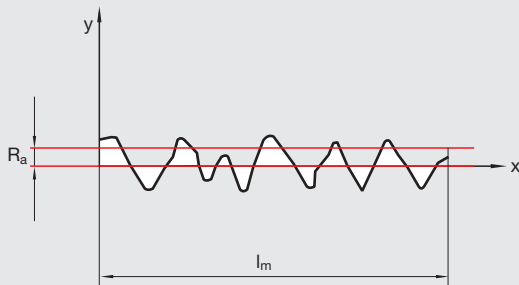

General recommendation

- The surface quality can be improved by using higher cutting speeds and positive rake angles.
- Use a smaller corner radius if there is a risk of vibration.
- Especially high quality surfaces can be achieved using uncoated hard metals (sharper cutting edges than coated grades).

R _{max}	R _a = CLA = AA		RMS		Rauigkeitswert Value for roughness
	µm	µinch	µm	µinch	
1,6	0,30	11,8	0,33	13,1	
1,8	0,35	13,8	0,39	15,3	
2,0	0,40	15,7	0,44	17,4	N5
2,2	0,44	17,5	0,49	19,4	
2,4	0,49	19,2	0,54	21,3	
2,6	0,53	20,8	0,59	23,1	
2,8	0,58	22,7	0,64	25,2	
3,0	0,63	24,6	0,70	27,3	
3,5	0,71	27,8	0,79	30,9	
4,0	0,80	31,4	0,89	34,8	N6
4,5	0,90	35,2	1,00	39,1	
5,0	0,99	38,8	1,10	43,1	
6,0	1,20	47,2	1,30	52,4	
7,0	1,40	55,1	1,50	61,2	
8,0	1,60	63,0	1,80	70,0	N7
9,0	1,80	71,0	2,00	78,8	
10,0	2,00	97,0	2,20	87,7	
15,0	3,20	126,0	3,10	140,0	N8
20,0	4,40	173,0	4,90	192,0	
25,0	5,80	238,0	6,40	264,0	
27,0	6,30	247,0	7,00	274,0	N9
30,0	7,40	292,0	8,20	324,0	
35,0	8,80	346,0	9,80	384,0	
40,0	10,70	422,0	11,90	468,0	
45,0	12,50	485,0	13,90	538,0	N10

Vorgangsweise:

Umwandlungstabelle für die verschiedenen Messsysteme. Es lässt sich keine rechnerische Beziehung zwischen der Rautiefe R_{max} und dem Wert R_a herstellen.

Aus der Umwandlungstabelle den in Frage kommenden R_{max}-Wert entnehmen. Danach aus dem Diagramm die richtige Kombination von Eckenradius und Vorschub ablesen.

Procedure:

Conversion table for various measurement systems. This cannot be used to calculate a mathematical relationship between the R_{max} roughness height and the figure for R_a.

Look up the appropriate R_{max} value in the conversion table. Then read off the correct combination of corner radius and feed rate.



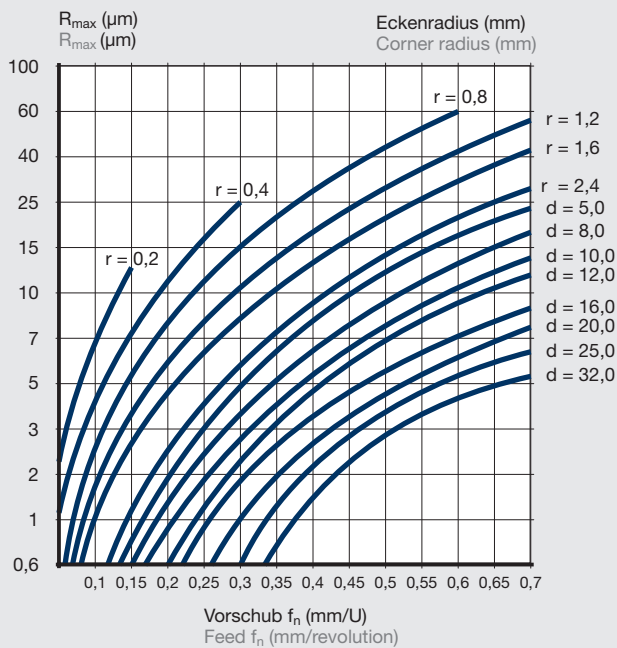



Das Diagramm zeigt theoretische R_{max}-Werte für bestimmte Vorschub-/Eckenradius-Kombinationen.
The diagram shows theoretical R_{max} values for specific feed/corner radius combinations.



Berechnungseinheiten Units		
Kurzbezeichnung Code	Bezeichnung Description	Einheiten Unit
D _m	Bearbeitungsdurchmesser Machining diameter	mm
v _c	Schnittgeschwindigkeit Cutting speed	m/min
n	Anzahl Spindelumdrehungen No. of spindle revolutions	min ⁻¹ r.p.m.
T _c	Eingriffszeit Working time	min
Q	Zerspanungsvolumen Metal removal volume	cm ³ /min
l _m	Bearbeitungslänge Working length	mm
P _c	Netto-Antriebsleistung Net power consumption	kW
k _{c 0,4}	Spezifische Schnittkraft für Spandicke 0,4 mm Specific cutting force for chip thickness of 0.4 mm	N/mm ²
f _n	Vorschub pro Umdrehung Feed per revolution	mm/U mm/rev
κ _r	Anstellwinkel Approach angle	Grad degrees
R _{max}	Profiltiefe Profile depth	µm
r _ε	Schneidplattenradius Indexable insert corner radius	mm
a _p	Schnitttiefe Cutting depth	mm

Formeln Formulas		
	Schnittgeschwindigkeit (m/min) Cutting speed (m/min)	$v_c = \frac{D_m \cdot \pi \cdot n}{1000}$
	Anzahl Spindelumdrehungen (min ⁻¹) No. of spindle revolutions r.p.m.	$n = \frac{v_c \cdot 1000}{D_m \cdot \pi}$
	Zerspanungsvolumen (cm ³ /min) Metal removal volume (cm ³ /min)	$Q = v_c \cdot a_p \cdot f_n$
	Antriebsleistung (kW) Power consumption (kW)	$P_c = \frac{Q \cdot k_{c 0,4}}{60 \cdot 1000} \left[\frac{0,4}{f_n \cdot \sin \kappa_r} \right]^{0,29}$
	Eingriffszeit (min) Working time (min)	$T_c = \frac{l_m}{f_n \cdot n}$
	Profiltiefe (µm) Profile depth (µm)	$R_{max} = \frac{f_n^2}{r_\epsilon} \cdot 125$

Abhilfe Option	Problem Problem											
	Extremer Freiflächenverschleiß Wear of free areas	Extremer Kolkverschleiß Extreme crater wear	Aufbauschneidendenbildung Formation of built-up edge	Schneidkantenausbrüche Chips in cutting edge	Kerbverschleiß Notch sensibility	Plattenbruch Broken indexable insert	Wärmerisse Heat cracks	Plastische Verformung Plastic deformation	Unterbrochener Schnitt Interrupted cut	Schlechte Werkstückoberfläche Poor workpiece surface	Band-Wirrsinn (nicht angelauten) Band/snarl chips (not coloured)	Zu enge Spanform (blau angelauten) Chip shape too narrow (blueing)
HM-Verschleißfestigkeit T/C wear resistance	↑				↑			↑				
HM-Zähigkeit T/C roughness				↑		↑	↑		↑			
Schnittgeschwindigkeit Cutting speed	↓	↓	↑		↓			↓	↑	↑		
Vorschub Feed	↔	↓	↓					↓	↓	↓	↑	↓
Schnitttiefe Depth of cut					↔				↑		↔	↔
Spanwinkel Chip angle		↑	↑	↓		↓			↔			
Spanformgeometrie Chip breaker geometry				↔		↔					↔	↔
Zustand der Schneidkante Condition of cutting edge				↔					↔			
Platten-Eckenradius Corner radius						↑			↑	↑		
Anstellwinkel Approach angle				↓								
Stabilität Stability				↑								
Kühlung Cooling		↑	↑				↑	↑		↑		
<p> ↑ erhöhen, vergrößern ↓ vermindern, verkleinern ↔ optimieren, kontrollieren increase reduce optimize </p>												

Werkstoffgruppe Material group	Werkstoff Material	Brinell Härte Brinell hardness HB	Schnittgeschwindigkeit Cutting speed v_c (m/min)			
			LCP15T			
			$f = \text{mm/U rev}$			
			0,4 – 0,8	0,25 – 0,4	0,05 – 0,25	
			 	 	 	
P	Unlegierter Stahl ¹⁾ Unalloyed steel ¹⁾	ca. 0,15 %C gegläht ≈ 0,15 %C annealed	125	140 – 200	230 – 300	290 – 360
		ca. 0,45 %C gegläht ≈ 0,45 %C annealed	190	110 – 180	180 – 260	250 – 320
		ca. 0,45 %C vergütet ≈ 0,45 %C hardened and temp.	250	90 – 180	110 – 180	140 – 210
		ca. 0,75 %C gegläht ≈ 0,75 %C annealed	270	120 – 180	170 – 240	230 – 300
		ca. 0,75 %C vergütet ≈ 0,75 %C hardened and temp.	300	130 – 150	80 – 150	140 – 210
	Niedrig legierter Stahl ¹⁾ Low-alloy steel ¹⁾	geglüht annealed	180	100 – 170	150 – 220	220 – 300
		vergütet hardened and temp.	275	100 – 150	110 – 180	140 – 210
		vergütet hardened and temp.	300	100 – 140	100 – 170	130 – 200
		vergütet hardened and temp.	350	100–140	80 – 150	110 – 180
	Hochlegierter Stahl und hochlegierter Werkzeugstahl ¹⁾ High-alloy steel and high alloy tool steel ¹⁾	geglüht annealed	200	100 – 180	80 – 220	180 – 260
		gehärtet und angelassen hardened and temp.	325	100 – 160	80 – 140	100 – 170
	Nichtrostender Stahl ¹⁾ Stainless steel ¹⁾	ferritisch/martensitisch gegläht ferritic/martensitic annealed	200	100–170	130 – 200	180 – 260
martensitisch vergütet martensitic hardened and temp.		240	100 – 140	80 – 150	150 – 210	
K	Grauguss Grey cast iron	perlitisches/ferritisch perlitic/ferritic	180	100 – 180	170 – 240	250 – 320
		perlitisches (martensitisch) perlitic (martensitic)	260	90 – 120	80 – 150	110 – 180
	Gusseisen mit Kugelgraphit Nodular graphite cast iron	ferritisch ferritic	160	100 – 150	110 – 180	140 – 210
		perlitisches perlitic	250	90 – 140	90 – 160	110 – 180
	Temperguss Malleable cast iron	ferritisch ferritic	130	90 – 140	120 – 190	150 – 210
		perlitisches perlitic	230	90 – 120	100 – 150	110 – 180

¹⁾ und Stahlguss
and cast steel



Trockenbearbeitung
Dry machining







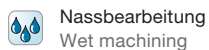
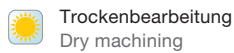

Nassbearbeitung
Wet machining

Werkstoffgruppe Material group	Werkstoff Material		Brinell Härte Brinell hardness HB	Schnittgeschwindigkeit Cutting speed v_c (m/min)		
				LCP25T		
				$f = \text{mm/U rev}$		
				0,4–0,8	0,25–0,4	0,05–0,25
P	Unlegierter Stahl ¹⁾ Unalloyed steel ¹⁾	ca. 0,15 %C gegläht ≈0,15 %C annealed	125	120 – 190	170 – 250	170 – 250
		ca. 0,45 %C gegläht ≈0,45 %C annealed	190	100 – 180	150 – 200	150 – 220
		ca. 0,45 %C vergütet ≈0,45 %C hardened and temp.	250	80 – 150	100 – 170	120 – 200
		ca. 0,75 %C gegläht ≈0,75 %C annealed	270	100 – 170	80 – 140	140 – 200
		ca. 0,75 %C vergütet ≈0,75 %C hardened and temp.	300	70 – 140	100 – 160	100 – 170
	Niedrig legierter Stahl ¹⁾ Low-alloy steel ¹⁾	geglüht annealed	180	90 – 160	140 – 200	140 – 200
		vergütet hardened and temp.	275	90 – 140	100 – 160	100 – 180
		vergütet hardened and temp.	300	85 – 130	100 – 150	100 – 170
		vergütet hardened and temp.	350	80 – 120	80 – 140	90 – 170
	Hochlegierter Stahl und hochlegierter Werkzeugstahl ¹⁾ High-alloy steel and high alloy tool steel ¹⁾	geglüht annealed	200	90 – 150	80 – 170	130 – 170
		gehärtet und angelassen hardened and temp.	325	50 – 110	70 – 130	80 – 130
	Nichtrostender Stahl ¹⁾ Stainless steel ¹⁾	ferritisch/martensitisch gegläht ferritic/martensitic annealed	200	90 – 140	120 – 180	140 – 180
martensitisch vergütet martensitic hardened and temp.		240	85 – 120	80 – 140	100 – 140	
M	Nichtrostender Stahl ¹⁾ Stainless steel ¹⁾	austenitisch ²⁾ , abgeschreckt austenitic ²⁾ , quenched	180	90 – 110	100 – 130	100 – 130

¹⁾ und Stahlguss
and cast steel

²⁾ und austenitische/ferritische
and austenitic/ferritic



Werkstoffgruppe Material group	Werkstoff Material	Brinell Härte Brinell hardness HB	Schnittgeschwindigkeit Cutting speed v_c (m/min)			
			LC240F			
			$f = \text{mm/U rev}$			
			0,4 – 0,8	0,25 – 0,4	0,05 – 0,25	
			 	 	 	
P	Unlegierter Stahl ¹⁾ Unalloyed steel ¹⁾	ca. 0,15 %C gegläht ≈ 0,15 %C annealed	125	60 – 100	70 – 110	90 – 170
		ca. 0,45 %C gegläht ≈ 0,45 %C annealed	190	60 – 100	70 – 110	90 – 170
		ca. 0,45 %C vergütet ≈ 0,45 %C hardened and temp.	250	60 – 100	70 – 110	90 – 170
		ca. 0,75 %C gegläht ≈ 0,75 %C annealed	270	60 – 100	70 – 110	90 – 170
		ca. 0,75 %C vergütet ≈ 0,75 %C hardened and temp.	300	60 – 100	70 – 110	90 – 170
	Niedrig legierter Stahl ¹⁾ Low-alloy steel ¹⁾	geglüht annealed	180	60 – 100	70 – 110	90 – 170
		vergütet hardened and temp.	275	70 – 110	70 – 110	90 – 170
			300	60 – 100	70 – 110	90 – 170
			350	55 – 80	70 – 110	90 – 170
	Hochlegierter Stahl und hochlegierter Werkzeugstahl ¹⁾ High-alloy steel and high alloy tool steel ¹⁾	geglüht annealed	200	80 – 110	70 – 110	90 – 170
		gehärtet und angelassen hardened and temp.	325	60 – 90	70 – 110	90 – 170
	Nichtrostender Stahl ¹⁾ Stainless steel ¹⁾	ferritisch/martensitisch gegläht ferritic/martensitic annealed	200	90 – 130	70 – 110	90 – 170
		martensitisch vergütet martensitic hardened and temp.	240	70 – 110	70 – 110	90 – 170
M	Nichtrostender Stahl ¹⁾ Stainless steel ¹⁾	austenitisch ²⁾ , abgeschreckt austenitic ²⁾ , quenched	180	70 – 100	90 – 140	110 – 170

¹⁾ und Stahlguss
and cast steel

²⁾ und austenitische/ferritische
and austenitic/ferritic

 Trockenbearbeitung
Dry machining

 Nassbearbeitung
Wet machining

Werkstoffgruppe Material group	Werkstoff Material	Brinell Härte HB Brinell hardness HB	LCM20T										
			Negative Wendepplatten Negative indexable inserts ISO-P-System					Positive Wendepplatten Positive indexable inserts ISO-S-System					
			Geometrie Geometry	Eckenradius Corner radius	Empfohlene a_p (mm) Recommended a_p (mm)	Empfohlene f_n (mm/U) Recommended f_n (mm/rev)	Schnittgeschwindigkeit v_c (m/min) Cutting speed v_c (m/min)	Geometrie Geometry	Eckenradius Corner radius	Empfohlene a_p (mm) Recommended a_p (mm)	Empfohlene f_n (mm/U) Recommended f_n (mm/rev)	Schnittgeschwindigkeit v_c (m/min) Cutting speed v_c (m/min)	
M	Ferritisch Ferritic 1.4000, 1.4002, 1.4003, 1.4006, 1.4016, 1.4104, 1.4113, 1.4313, 1.4742, 1.4762	180	MM	08	2	0,20	180 – 230	MM	04	1	0,15	180 – 230	
				12	3	0,30	180 – 230		08	2	0,25	180 – 230	
	Martensitisch Martensitic 1.4006, 1.4014, 1.4021, 1.4024, 1.4027, 1.4028, 1.4031, 1.4034, 1.4057, 1.4122, 1.4724	320	MM	08	2	0,20	180 – 230	MM	04	1	0,15	180 – 230	
				12	3	0,30	180 – 230		08	2	0,25	180 – 230	
Austenitisch Austenitic 1.4300, 1.4301, 1.4303, 1.4305, 1.4306, 1.4308, 1.4310, 1.4311	180	MM	08	2	0,2	150 – 200	MM	04	1	0,15	150 – 200		
			12	3	0,3	150 – 200		08	2	0,20	150 – 200		
	1.4321, 1.4401, 1.4404, 1.4406, 1.4428, 1.4435, 1.4436, 1.4438, 1.4449 1.4571	180	MM	08	2	0,2	150 – 200	MM	04	1	0,15	150 – 200	
				12	3	0,3	150 – 200		08	2	0,2	150 – 200	

Die angegebenen Schnittdatenrichtwerte sind Empfehlungen für Anwendungen mit Kühlschmierstoff.
Bei Trockenbearbeitung reduzieren Sie die Schnittgeschwindigkeit v_c um ca. 20 %.
The above recommendations are given for wet machining. For dry machining the recommended values for the cutting speed have to be reduced by approx. 20 %.

Werkstoffgruppe Material group	BCM25T													
	Negative Wendepplatten Negative indexable inserts ISO-P-System							Positive Wendepplatten Positive indexable inserts ISO-S-System						
	Brinell Härte HB Brinell hardness HB	Geometrie Geometry	Eckenradius Corner radius	Empfohlene a_p (mm) Recommended a_p (mm)	Empfohlene f_n (mm/U) Recommended f_n (mm/rev)	Schnittgeschwindigkeit v_c (m/min) Cutting speed v_c (m/min)	Geometrie Geometry	Eckenradius Corner radius	Empfohlene a_p (mm) Recommended a_p (mm)	Empfohlene f_n (mm/U) Recommended f_n (mm/rev)	Schnittgeschwindigkeit v_c (m/min) Cutting speed v_c (m/min)			
M	Ferritisch Ferritic 1.4000, 1.4002, 1.4003, 1.4006, 1.4016, 1.4104, 1.4113, 1.4313, 1.4742, 1.4762	180	MM	08	2	0,2	130 - 200	MM	04	1	0,15	130 - 200		
				12	3	0,3	130 - 200		08	2	0,25	130 - 200		
				16	3,5	0,3	130 - 200							
		BFMS	04	1	0,15	130 - 200								
			08	2,5	0,25	130 - 200								
			12	3	0,3	130 - 200								
			BMS	08	2	0,2	130 - 200							
				12	3	0,3	130 - 200							
		Martensitisch Martensitic 1.4006, 1.4014, 1.4021, 1.4024, 1.4027, 1.4028, 1.4031, 1.4034, 1.4057, 1.4122, 1.4724	320	MM	08	2	0,2	130 - 200	MM	04	1	0,15	130 - 200	
					12	3	0,3	130 - 200		08	2	0,25	130 - 200	
					16	3,5	0,3	130 - 200						
	BFMS		04	1	0,15	130 - 200								
			08	2,5	0,25	130 - 200								
			12	3	0,3	130 - 200								
			BMS	08	2	0,2	130 - 200							
				12	3	0,3	130 - 200							
	Austenitisch Austenitic 1.4300, 1.4301, 1.4303, 1.4305, 1.4306, 1.4308, 1.4310, 1.4311 1.4321, 1.4401, 1.4404, 1.4406, 1.4428, 1.4435, 1.4436, 1.4438, 1.4449 1.4571		180	MM	08	2	0,2	100 - 180	MM	04	1	0,15	100 - 180	
					12	3	0,3	100 - 180		08	2	0,20	100 - 180	
					16	3,5	0,3	100 - 180						
		BFMS		04	1	0,15	100 - 180							
				08	2,5	0,25	100 - 180							
				12	3	0,3	100 - 180							
BMS				08	2	0,2	100 - 180							
				12	3	0,3	100 - 180							
180		MM		08	2	0,2	100 - 180	MM	04	1	0,15	100 - 180		
				12	3	0,3	100 - 180		08	2	0,2	100 - 180		
				16	3,5	0,3	100 - 180							
		BFMS	04	1	0,15	100 - 180								
			08	2,5	0,25	100 - 180								
			12	3	0,3	100 - 180								
			BMS	08	2	0,2	100 - 180							
				12	3	0,3	100 - 180							

Die angegebenen Schnittdatenrichtwerte sind Empfehlungen für Anwendungen mit Kühlschmierstoff.

Bei Trockenbearbeitung reduzieren Sie die Schnittgeschwindigkeit v_c um ca. 20 %.

The above recommendations are given for wet machining. For dry machining the recommended values for the cutting speed have to be reduced by approx. 20 %.

Werkstoffgruppe Material group	BCM40T												
	Negative Wendepplatten Negative indexable inserts ISO-P-System							Positive Wendepplatten Positive indexable inserts ISO-S-System					
	Brinell Härte HB Brinell hardness HB												
	Geometrie Geometry	Eckenradius Corner radius	Empfohlene a_p (mm) Recommended a_p (mm)	Empfohlene f_n (mm/U) Recommended f_n (mm/rev)	Schnittgeschwindigkeit v_c (m/min) Cutting speed v_c (m/min)	Geometrie Geometry	Eckenradius Corner radius	Empfohlene a_p (mm) Recommended a_p (mm)	Empfohlene f_n (mm/U) Recommended f_n (mm/rev)	Schnittgeschwindigkeit v_c (m/min) Cutting speed v_c (m/min)			
M	Ferritisch Ferritic 1.4000, 1.4002, 1.4003, 1.4006, 1.4016, 1.4104, 1.4113, 1.4313, 1.4742, 1.4762	180	MM	08	2	0,2	100 - 180						
				12	3	0,3	100 - 180						
				16	3,5	0,3	100 - 180						
			BMRS	12	4	0,45	100 - 180						
				16	5	0,5	100 - 180						
	Martensitisch Martensitic 1.4006, 1.4014, 1.4021, 1.4024, 1.4027, 1.4028, 1.4031, 1.4034, 1.4057, 1.4122, 1.4724	320	MM	08	2	0,2	100 - 180						
				12	3	0,3	100 - 180						
				16	3,5	0,3	100 - 180						
			BMRS	12	4	0,45	100 - 180						
				16	5	0,5	100 - 180						
	Austenitisch Austenitic 1.4300, 1.4301, 1.4303, 1.4305, 1.4306, 1.4308, 1.4310, 1.4311	180	MM	08	2	0,2	90 - 160						
				12	3	0,3	90 - 160						
				16	3,5	0,3	90 - 160						
		BMRS	12	4	0,45	80 - 160							
			16	5	0,5	80 - 160							
1.4321, 1.4401, 1.4404, 1.4406, 1.4428, 1.4435, 1.4436, 1.4438, 1.4449 1.4571	180	MM	08	2	0,2	90 - 160							
			12	3	0,3	90 - 160							
			16	3,5	0,3	90 - 160							
		BMRS	12	4	0,45	80 - 160							
			16	5	0,5	80 - 160							

Die angegebenen Schnittdatenrichtwerte sind Empfehlungen für Anwendungen mit Kühlschmierstoff.

Bei Trockenbearbeitung reduzieren Sie die Schnittgeschwindigkeit v_c um ca. 20 %.

The above recommendations are given for wet machining. For dry machining the recommended values for the cutting speed have to be reduced by approx. 20 %.

Werkstoffgruppe Material group	Werkstoff Material	Brinell Härte HB Brinell hardness HB	LC435D														
			Negative Wendepplatten Negative indexable inserts ISO-P-System					Positive Wendepplatten Positive indexable inserts ISO-S-System									
			Geometrie Geometry	Eckenradius Corner radius	Empfohlene a_p (mm) Recommended a_p (mm)	Empfohlene f_n (mm/U) Recommended f_n (mm/rev)	Schnittgeschwindigkeit v_c (m/min) Cutting speed v_c (m/min)	Geometrie Geometry	Eckenradius Corner radius	Empfohlene a_p (mm) Recommended a_p (mm)	Empfohlene f_n (mm/U) Recommended f_n (mm/rev)	Schnittgeschwindigkeit v_c (m/min) Cutting speed v_c (m/min)					
M	Ferritisch Ferritic 1.4000, 1.4002, 1.4003, 1.4006, 1.4016, 1.4104, 1.4113, 1.4313, 1.4742, 1.4762	180	BFMS	04	0,5	0,15	150 – 180										
				08	1	0,20	150 – 180										
				12	2	0,25	120 – 180										
			BMS	08	2	0,25	150 – 180	BSMS	04	0,4	0,15	120 – 180					
				12	3	0,30	150 – 180		08	1	0,20	140 – 180					
				16	4	0,35	120 – 180										
			BMRS	08	3	0,35	140 – 180										
				12	4	0,45	140 – 180										
				16	5	0,50	120 – 160										
			Martensitisch Martensitic 1.4006, 1.4014, 1.4021, 1.4024, 1.4027, 1.4028, 1.4031, 1.4034, 1.4057, 1.4122, 1.4724	320	BFMS	04	0,5	0,15	140 – 180								
						08	1	0,20	120 – 180								
						12	2	0,25	110 – 160								
	BMS	08			2	0,25	120 – 180	BSMS	04	0,4	0,15	140 – 180					
		12			3	0,30	110 – 160		08	1	0,20	120 – 180					
		16			4	0,35	100 – 140										
	BMRS	08			3	0,35	110 – 160										
		12			4	0,45	100 – 140										
		16			5	0,50	90 – 130										
	Austenitisch Austenitic 1.4300, 1.4301, 1.4303, 1.4305, 1.4306, 1.4308, 1.4310, 1.4311 1.4321, 1.4401, 1.4404, 1.4406, 1.4428, 1.4435, 1.4436, 1.4438, 1.4449 1.4571	180			BFMS	04	0,5	0,15	90 – 160								
						08	1	0,20	90 – 160								
						12	2	0,25	90 – 160								
			BMS	08	2	0,25	80 – 150	BSMS	04	0,4	0,15	120 – 150					
				12	3	0,30	80 – 150		08	1	0,20	150 – 180					
				16	4	0,35	80 – 150										
BMRS			08	3	0,35	70 – 150											
			12	4	0,45	70 – 150											
			16	5	0,50	70 – 150											
BFMS			04	0,5	0,15	90 – 160											
			08	1	0,20	90 – 160											
			12	2	0,25	90 – 160											
BMS	08	2	0,25	80 – 150	BSMS	04	0,4	0,15	150 – 180								
	12	3	0,30	80 – 150		08	1	0,20	120 – 180								
	16	4	0,35	80 – 150													
BMRS	08	3	0,35	70 – 150													
	12	4	0,45	70 – 150													
	16	5	0,50	70 – 150													

Die angegebenen Schnittdatenrichtwerte sind Empfehlungen für Anwendungen mit Kühlschmierstoff.
Bei Trockenbearbeitung reduzieren Sie die Schnittgeschwindigkeit v_c um ca. 20 %.
The above recommendations are given for wet machining. For dry machining the recommended values for the cutting speed have to be reduced by approx. 20 %.

Werkstoffgruppe Material group	Werkstoff Material		Brinell Härte Brinell hardness HB	Schnittgeschwindigkeit Cutting speed v_c (m/min)		
				BCK10T und and BCK20T		
				f = mm/U rev		
				0,4 – 0,8	0,25 – 0,4	0,05 – 0,25
K	Grauguss Grey cast iron	perlitisch/ferritisch perlitic/ferritic	180	210 – 300	300 – 450	350 – 500
		perlitisch (martensitisch) perlitic (martensitic)	260	140 – 200	170 – 240	190 – 270
	Gusseisen mit Kugelgraphit Nodular graphite cast iron	ferritisch ferritic	160	150 – 210	180 – 260	210 – 300
		perlitisch perlitic	250	110 – 160	130 – 190	150 – 200
	Temperguss Malleable cast iron	ferritisch ferritic	130	200 – 280	220 – 300	240 – 330
		perlitisch perlitic	230	100 – 150	140 – 220	170 – 240

 Nassbearbeitung
Wet machining

Schnittwertempfehlungen für Drehen LCM45T
Turning data recommendations for LCM45T

Dreh-Bohr-Werkzeug Pentatec®
Turning-drilling-tool Pentatec®

Werkstoffgruppe Material group	Gliederung der Werkstoff-Hauptgruppen und Kennbuchstaben Main workpiece material groups and their characteristic letters		Brinell Härte Brinell hardness HB	Drehen und Bohren Turning and drilling v_c m/min	
	Werkstückstoff			LCM45T	
P	Unlegierter Stahl ¹⁾ Unalloyed steel ¹⁾	ca 0,15%C geglüht ≈0,15%C annealed	125	120 - 250	Vorschubwerte Pentatec siehe Seite 144 - 145 Feed value Pentatec see page 144 -145
		ca 0,45%C geglüht ≈0,45%C annealed	190	100 - 200	
		ca 0,45%C vergütet ≈0,45%C hardened and temp.	250	70 - 180	
		ca 0,75%C geglüht ≈0,75%C annealed	270	70 - 180	
		ca 0,75%C vergütet ≈0,75%C hardened and temp.	300	50 - 150	
	Niedrig legierter Stahl ¹⁾ Low-alloy steel ¹⁾	geglüht annealed	180	80 - 200	
		vergütet hardened and temp.	275	70 - 180	
		vergütet hardened and temp.	300	100 - 185	
		vergütet hardened and temp.	350	70 - 150	
	Hochlegierter Stahl und hochleg. Werkzeugstahl High-alloy steel and high-alloy tool steel ¹⁾	geglüht annealed	200	70 - 180	
gehärtet und angelassen hardened and temp.		325	50 - 120		
ferritisch / martensitisch geglüht ferritic / martensitic annealed		200	70 - 150		
martensitisch vergütet martensitic hardened and temp.		240	70 - 120		
M	Nichtrostender Stahl ¹⁾ Stainless steel ¹⁾	austenitisch ²⁾ , abgeschreckt austenitic ²⁾ , quenched	180	50 - 150	

¹⁾ und Stahlguss

¹⁾ and cast steel

²⁾ und austenitische / ferritische

²⁾ and austenitic / ferritic



Werkstoffgruppe Material group	Werkstoff Material	Brinell Härte Brinell hardness HB	Schnittgeschwindigkeit Cutting speed v_c (m/min)			
			LC610T			
			f = mm/U rev			
			0,4–0,8	0,25–0,4	0,05–0,25	
M	Nichtrostender Stahl ¹⁾ Stainless steel ¹⁾	austenitisch ²⁾ , abgeschreckt austenitic ²⁾ , quenched			120 – 300	
K	Grauguss Grey cast iron	perlitisch/ferritisch perlitic/ferritic	180		80 – 250	
		perlitisch (martensitisch) perlitic (martensitic)	180			
	Gusseisen mit Kugelgraphit Nodular graphite cast iron	ferritisch ferritic	260		70 – 200	
		perlitisch perlitic	160			
	Temperguss Malleable cast iron	ferritisch ferritic	250		80 – 220	
		perlitisch perlitic	130			
N	Aluminium-Knetlegierungen Aluminium wrought alloys	nicht aushärtbar unhardenable	230	500 – 2000	600 – 2500	700 – 3000
		aushärtbar, ausgehärtet hardenable, hardened	60	200 – 1000	300 – 1500	400 – 2000
	Aluminium-Gusslegierungen Aluminium cast alloys	ca. 12 % Si. nicht aushärtbar ca. 12 % Si. unhardenable	100	400 – 800	500 – 1200	600 – 1500
		ca. 12 % Si. aushärtbar, ausgehärtet ca. 12 % Si. hardenable, hardened	75	300 – 600	400 – 900	500 – 1200
		> 12 % Si. nicht aushärtbar > 12 % Si. unhardenable	90	200 – 600	300 – 800	400 – 1000
	Kupfer und Kupferlegierungen (Bronze/Messing) Copper and copper alloys (Bronze/Brass)	Automatenlegierung Pb > 1 % Free cutting alloys Pb > 1 %	130	250 – 400	250 – 500	450 – 650
		Messing, Rotguss Brass, Red bronze	110	250 – 600	250 – 800	450 – 1000
		Bronze, bleifreies Kupfer und Elektrolytkupfer Bronze, non leaded copper and electrolytic copper	90 100	150 – 250	180 – 300	200 – 400
	Nichtmetallische Werkstoffe Nonmetallic materials	Duroplaste Duroplastics		60 – 70	80 – 100	90 – 120
		Faserverstärkte Kunststoffe Fibre reinforced plastics				
		Hartgummi Hard rubber				

¹⁾ und Stahlguss
and cast steel

²⁾ und austenitische/ferritische
and austenitic/ferritic



Nassbearbeitung
Wet machining

Werkstoffgruppe Material group	Werkstoff Material		Brinell Härte Brinell hardness HB	Schnittgeschwindigkeit Cutting speed
				v_c (m/min)
				LW610 und and LW611
				$f = \text{mm/U rev}$
				0,1–0,4
				 
K	Grauguss Grey cast iron	perlitisch/ferritisch perlitic/ferritic	180	150 – 250
		perlitisch (martensitisch) perlitic (martensitic)	260	100 – 150
	Gusseisen mit Kugelgraphit Nodular graphite cast iron	ferritisch ferritic	160	130 – 180
		perlitisch perlitic	250	100 – 150
	Temperguss Malleable cast iron	ferritisch ferritic	130	120 – 180
		perlitisch perlitic	230	100 – 160
N	Aluminium-Knetlegierungen Aluminium wrought alloys	nicht aushärtbar unhardenable	60	400 – 2400
		aushärtbar, ausgehärtet hardenable, hardened	100	160 – 1600
	Aluminium-Gusslegierungen Aluminium cast alloys	ca. 12 % Si. nicht aushärtbar ca. 12 % Si. unhardenable	75	320 – 1200
		ca. 12 % Si. aushärtbar, ausgehärtet ca. 12 % Si. hardenable, hardened	90	240 – 950
		> 12 % Si. nicht aushärtbar > 12 % Si. unhardenable	130	160 – 800
		Kupfer und Kupferlegierungen (Bronze/Messing) Copper and copper alloys (Bronze/Brass)	Automatenlegierung Pb > 1 % Free cutting alloys Pb > 1 %	110
		Messing, Rotguss Brass, Red bronze	90	200 – 800
		Bronze, bleifreies Kupfer und Elektrolytkupfer Bronze, non leaded copper and electrolytic copper	100	120 – 320
		Nichtmetallische Werkstoffe Nonmetallic materials	Duroplaste Duroplastics	
	Faserverstärkte Kunststoffe Fibre reinforced plastics			
	Hartgummi Hard rubber			

 Trockenbearbeitung
Dry machining

 Nassbearbeitung
Wet machining

Werkstoffgruppe Material group	Werkstoff Material	Brinell Härte Brinell hardness HB	Schnittgeschwindigkeit Cutting speed v_c (m/min)	Vorschub Feed f mm/U rev
			LC415X	
P	Automatenstahl Machining steel	125 - 300	100 – 220	0,01 – 0,15
	Stahl Steel < 600 N/mm ²	180 - 380	100 – 180	0,01 – 0,20
	Stahl Steel < 800 N/mm ²	200 - 350	60 – 130	0,01 – 0,15
M	Nichtrostender Stahl Stainless steel	180 - 300	60 – 140	0,01 – 0,20
N	Aluminium Aluminium	30 - 130	200 – 800	0,01 – 0,30
	Bronze, Messing, Kupfer Bronze, Brass, Copper	100 - 500	100 – 500	0,01 – 0,30
S	Titan Titanium	180 - 400 180 - 400	40 – 90 30 – 70	0,01 – 0,15 0,2 – 0,45

Schnittwertempfehlungen für Drehen LC415Z und BCS20T
Cutting data recommendations for LC415Z and BCS20T

Werkstoffgruppe Material group	Werkstoff Material	Brinell Härte Brinell hardness HB	Schnittgeschwindigkeit Cutting speed v_c (m/min)	
			LC415Z / BCS20T f = mm/U rev 0,15 - 0,5	
M	Nichtrostender Stahl ¹⁾ Stainless steel ¹⁾	austenitisch ²⁾ , abgeschreckt austenitic ²⁾ , quenched	180 80 – 180	
S	Wärmefeste Legierungen Heat resistant alloys	Fe-Basis Fe-based	geglüht annealed	200 40 – 100
			ausgehärtet hardened	280 30 – 70
		Ni- oder Co-Basis Ni- or Co-based	geglüht annealed	250 50 – 85
			ausgehärtet hardened	350 20 – 50
			gegossen cast	320 30 – 50

Schnittwertempfehlungen für Drehen BCS10T
Cutting data recommendations for BCS10T

Werkstoffgruppe Material group	Werkstoff Material	Brinell Härte Brinell hardness HB	Schnittgeschwindigkeit Cutting speed v_c (m/min)
			BCS10T f = mm/U rev 0,2 - 0,45
S	Wärmefeste Legierungen Heat resistant alloys	Titan und Titan-Legierungen Titanium and titanium alloys	150 – 450 30 – 70

¹⁾ und Stahlguss
and cast steel

²⁾ und austenitische/ferritische
and austenitic/ferritic

Nassbearbeitung
Wet machining

Pentatec®

Pentatec®

Das universellste Dreh-Bohr-Werkzeug
Kostenreduktion auf allen Hauptwerkstoffen
The most universal turning-drilling-tool
Cost reduction on all main materials



Dreh-Bohr-Werkzeug Pentatec®	Turning-drilling-tool Pentatec®	
Fünf Bearbeitungsoperationen, ein Werkzeug	Five machining operations, one tool	137
Technische Hinweise	Technical Hints	
Konstruktionsmerkmale und weitere Anwendungsmöglichkeiten	Additional features and application possibilities	138
Bezeichnungssystem Pentatec®	Designation system Pentatec®	140
Pentatec® Halter	Pentatec® holders	141
Wendeschneidplatten	Indexable inserts	142
Technische Hinweise	Technical Hints	
Schneidstoffsorten, Übersicht	Grade designation, overview	143
Schnittparameter	Cutting parameters	144
Schnittwertempfehlungen, Dreh-Bohr-Werkzeug Pentatec	Cutting data recommendations, turning-drilling-tool Pentatec®	146
Bearbeitungsbeispiele	Machining examples	147



Fünf Bearbeitungsoperationen, ein Werkzeug

Das universelle Dreh-Bohr-Werkzeug ersetzt bis zu fünf ISO-Werkzeuge und reduziert die Bearbeitungszeiten um bis zu 30 % durch die Einsparung von Werkzeugwechselzeiten und Werkzeug-leerfahrten.

Five machining operations, one tool

The universal turning-drilling-tool substitutes up to 5 ISO-tools and reduces machining times up to 30 % through saving of tool changing times and unnecessary tool movements.

Nebenschneide einsetzbar
Secondary cutting edge can be used

Bohren ins Volle außer der Mitte, positiver Versatz
Drilling off center, positive offset

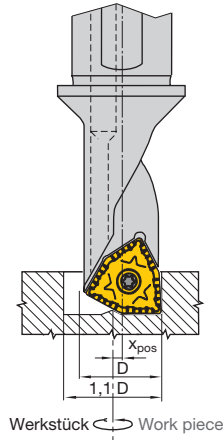

X_{pos} : Versatz aus der Mitte positiv
Offset off center, positive

D: Nenndurchmesser Werkzeug
Nominal tool diameter

Stahl $X_{pos} = \frac{(1,1 \times D) - D}{2}$
Steel

Aluminium $X_{pos} = \frac{(1,5 \times D) - D}{2}$
Aluminium

Werkzeug Tool	D	Stahl Steel		Aluminium Aluminium	
		D_{max}	x_{pos}	D_{max}	x_{pos}
2,25D/1,50D					
PTR/L 08 -x,xxD- 04	08H13	8,8	0,40	12,0	2,00
PTR/L 10 -x,xxD- 05	10H13	11,0	0,50	15,0	2,50
PTR/L 11 -x,xxD- 06	11H13	12,1	0,55	16,5	2,75
PTR/L 15 -x,xxD- 07	15H13	16,5	0,75	22,5	3,75
PTR/L 18 -x,xxD- 09	18H13	19,8	0,90	27,0	4,50
PTR/L 20 -x,xxD- 10	20H13	22,0	1,00	30,0	5,00
PTR/L 26 -x,xxD- 13	26H13	28,6	1,30	39,0	6,50

Bohren ins Volle außer der Mitte, negativer Versatz
Drilling off center, negative offset

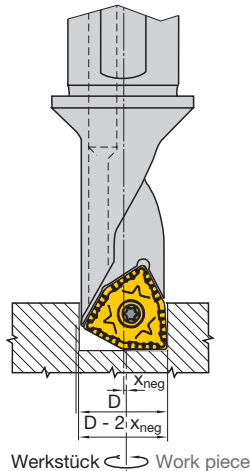

X_{neg} : Versatz aus der Mitte negativ
Offset off center, negative

D: Nenndurchmesser Werkzeug
Nominal tool diameter

$$X_{neg} = \frac{D_{min} - D}{2}$$

Werkzeug Tool	D	D_{min}	x_{neg}
2,25D/1,50D			
PTR/L 08 -x,xxD- 04	08H13	7,8	0,10
PTR/L 10 -x,xxD- 05	10H13	9,8	0,10
PTR/L 11 -x,xxD- 06	11H13	10,8	0,10
PTR/L 15 -x,xxD- 07	15H13	14,7	0,15
PTR/L 18 -x,xxD- 09	18H13	17,7	0,15
PTR/L 20 -x,xxD- 10	20H13	19,7	0,15
PTR/L 26 -x,xxD- 13	26H13	25,7	0,15

Anfasen innen
Internal chamfering

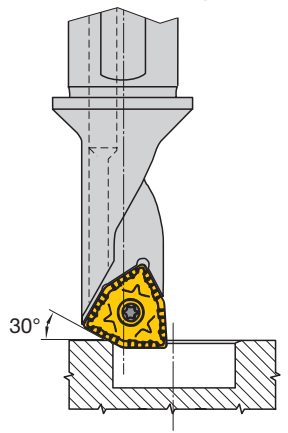

Anfasen außen
External chamfering

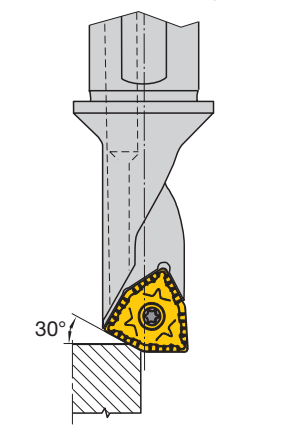

Senkbohrung mit Pentatec®-Werkzeugen
Core drilling with Pentatec®-tools

Die Durchmesserreihe der Pentatec®-Werkzeuge ist so ausgelegt, dass damit Senkbohrungen nach DIN 74 Form H3, J3 und K3 in einem Arbeitsgang produziert werden können.

The diameters of the Pentatec®-tools are designed to produce counter-bores according to DIN 74 forms H3, J3 and K3 in one operation.

- | | | |
|--------------|---|--|
| Form H3 für: | Zylinderschrauben nach DIN 84 und DIN 7984
Gewindeschneidschrauben nach DIN 7513 Form B
Gewindefurchende Schrauben nach DIN 7500 Teil 1 Form A | } mit Federring nach DIN 7980 |
| Form J3 für: | Zylinderschrauben nach DIN 6912
(niedriger Kopf, Schlüsselführung) | |
| Form K3 für: | Zylinderschrauben nach DIN 912 | |
| Form H3 for: | socket head cap screws according to DIN 84
and DIN 7984
cheese-head screws according to DIN 7513 form B
cheese-head screws according to DIN 7500 part 1 form A | } with lock washer according to DIN 7980 |
| Form J3 for: | socket head cap screws according to DIN 6912
(low screw head, key guide) | |
| Form K3 for: | socket head cap screws according to DIN 912 | |

Werkzeug Tool	Gewinde- Nenndurchmesser Thread nominal diameter	D	H13
2,25D/1,50D			
PTR/L 08 -x,xxD- 04	M 4	8	0/+0,220
PTR/L 10 -x,xxD- 05	M 5	10	0/+0,220
PTR/L 11 -x,xxD- 06	M 6	11	0/+0,270
PTR/L 15 -x,xxD- 07	M 8	15	0/+0,270
PTR/L 18 -x,xxD- 09	M 10	18	0/+0,330
PTR/L 20 -x,xxD- 10	M 12	20	0/+0,330
PTR/L 26 -x,xxD- 13	M 16	26	0/+0,330

Große Aufnahmedurchmesser und Plananlage
Large mounting diameter and location face

	Pentatec®		ISO-Bohrstange ISO-boring bar
	PTR20-2,25D	PTR20-1,50D	
D _{min}	20	20	21
d	25/32 ¹⁾	25	16
Schaft Shank			
Plananlage	Ja	Nein	Nein
Seating face	Yes	No	No

¹⁾ Durchmesser am Bund
 Diameter on the flange

Pentatec®-Nutzen: Höhere Stabilität und geringere Vibrationsneigung durch größere Aufnahmedurchmesser und zusätzliche Plananlage bei PT-2,25D
 Pentatec®-benefits: More stability and less tendency to vibrate through larger locating diameters and the additional seating face for PT-2,25D

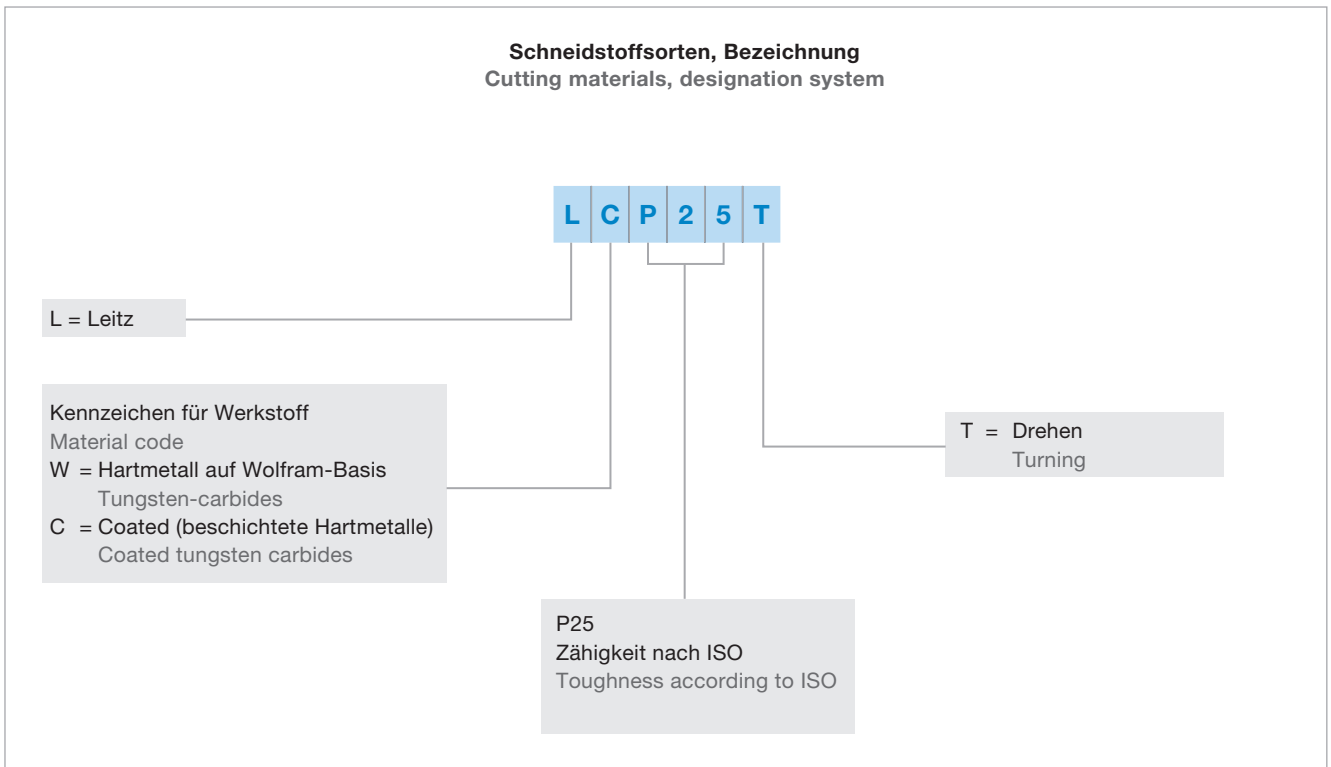
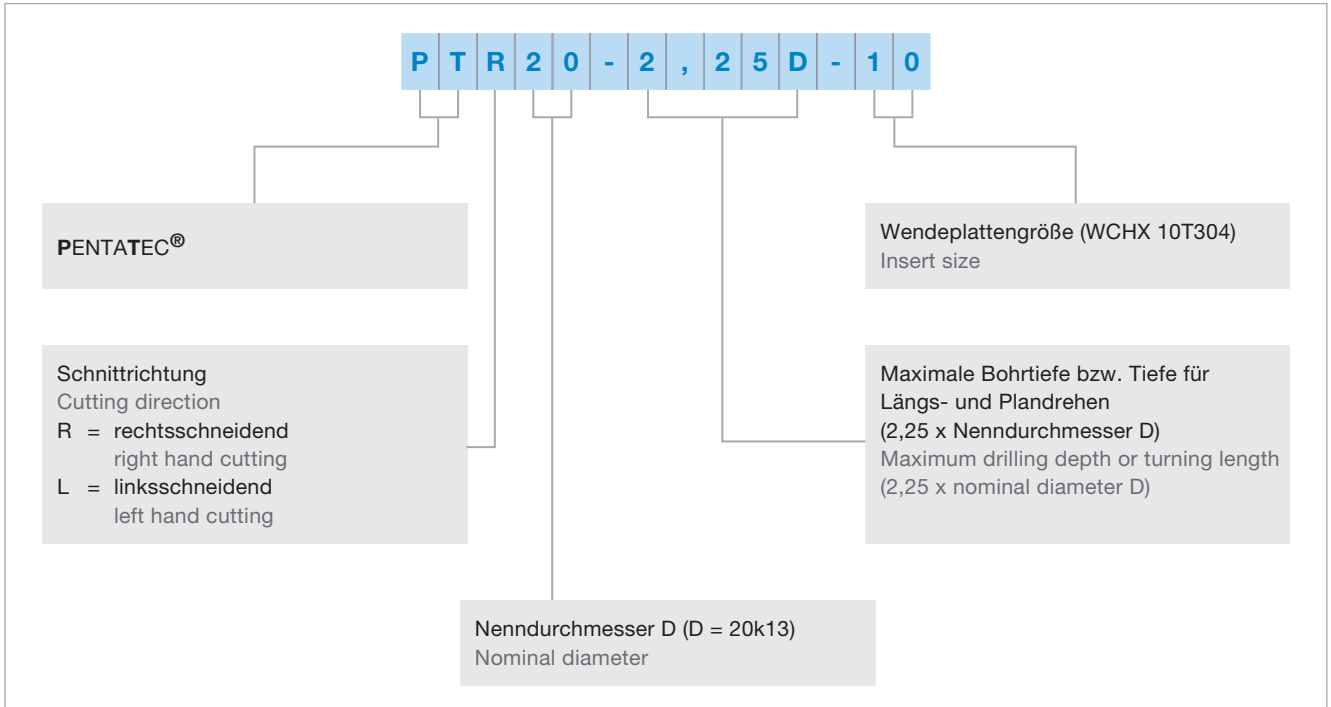

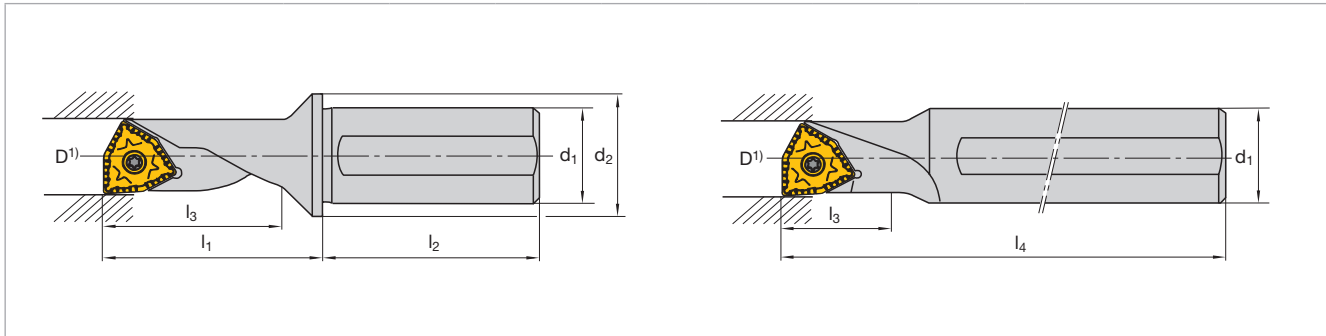







Bestellbezeichnung Ordering code	D ¹⁾	d ₁	d ₂	l ₁	l ₂	l ₃	l ₄	Passende Wendeplatte Indexable insert
PTR/L 08 - 2,25D-04	8	10	12	22,5	38	18,0	-	WCHX 04...
PTR/L 08 - 1,50D-04	8	12	-	-	-	12,0	80	
PTR/L 10 - 2,25D-05	10	12	16	28	42	22,5	-	WCHX 05...
PTR/L 10 - 1,50D-05	10	12	-	-	-	15,0	90	
PTR/L 11 - 2,25D-06	11	16	20	32	45	24,75	-	WCHX 06...
PTR/L 11 - 1,50D-06	11	16	-	-	-	16,5	100	
PTR/L 15 - 2,25D-07	15	20	25	43	50	33,75	-	WCHX 07...
PTR/L 15 - 1,50D-07	15	20	-	-	-	22,5	125	
PTR/L 18 - 2,25D-09	18	25	32	53	56	40,5	-	WCHX 09...
PTR/L 18 - 1,50D-09	18	25	-	-	-	27,0	135	
PTR/L 20 - 2,25D-10	20	25	32	56	56	45,0	-	WCHX 10...
PTR/L 20 - 1,50D-10	20	25	-	-	-	30,0	150	
PTR/L 26 - 2,25D-13	26	32	40	73	60	58,5	-	WCHX 13...
PTR/L 26 - 1,50D-13	26	32	-	-	-	39,0	180	

¹⁾ Durchmesser für Senkbohrung laut DIN 74
Diameter for plunge drilling according to DIN 74

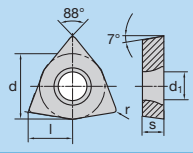
Auf Anfrage bieten wir Pentatec® Werkzeuge mit schwingungsdämpfenden Densimet (Schwermetall) an.
On request we offer Pentatec® tools with vibration damping Densimet (heavy duty metal).

Ersatzteile Spare parts				
	 Schraube Screw	 Schlüssel Key	Torx	Anzugsmoment Torque [Ncm]
PTR/L 08	A02-20033	V04-T0600	06	62
PTR/L 10	A13-25042	V04-T0800	08	128
PTR/L 11	A13-25050	V04-T0800	08	128
PTR/L 15	A13-30073	V04-T0800	08	180
PTR/L 18	A02-35082	V04-T1500	15	345
PTR/L 20	A06-50088	V04-T2000	20	1020
PTR/L 26	A02-60120	V04-T2500	25	1750

	Bestellbezeichnung Ordering code						Sorte Grade		
		l	d	s	d ₁	r	LCP25T	LCM45T	LW610
WCHX...FN-BAL 	WCHX 040102 FN-BAL	4,0	6,35	1,59	2,25	0,2			6409963
	WCHX 040104 FN-BAL	4,0	6,35	1,59	2,25	0,4			6407959
	WCHX 05T102 FN-BAL	5,0	7,93	1,98	2,80	0,2			6409964
	WCHX 05T104 FN-BAL	5,0	7,93	1,98	2,80	0,4			6407962
	WCHX 060202 FN-BAL	5,5	8,93	2,38	2,80	0,2			6409965
	WCHX 060204 FN-BAL	5,5	8,93	2,38	2,80	0,4			6407965
	WCHX 070304 FN-BAL	7,5	12,00	3,18	3,40	0,4			6409966
	WCHX 070308 FN-BAL	7,5	12,00	3,18	3,40	0,8			6407968
	WCHX 090304 FN-BAL	9,0	14,29	3,18	4,40	0,4			6409967
	WCHX 090308 FN-BAL	9,0	14,29	3,18	4,40	0,8			6407971
	WCHX 10T304 FN-BAL	10,0	15,87	3,97	5,90	0,4			6409968
	WCHX 10T308 FN-BAL	10,0	15,87	3,97	5,90	0,8			6400540
	WCHX 130508 FN-BAL	13,0	21,00	5,56	7,00	0,8			6407975
WCHX...EN-BFM 	WCHX 040102 EN-BFM	4,0	6,35	1,59	2,25	0,2	5056049		
	WCHX 040104 EN-BFM	4,0	6,35	1,59	2,25	0,4	5056050		
	WCHX 05T102 EN-BFM	5,0	7,93	1,98	2,80	0,2	5056051		
	WCHX 05T104 EN-BFM	5,0	7,93	1,98	2,80	0,4	5056052		
	WCHX 060202 EN-BFM	5,5	8,37	2,38	2,80	0,2	5056053		
	WCHX 060204 EN-BFM	5,5	8,37	2,38	2,80	0,4	5056054		
	WCHX 070304 EN-BFM	7,5	12,00	3,18	3,40	0,4	5056055		
	WCHX 070308 EN-BFM	7,5	12,00	3,18	3,40	0,8	5056056		
	WCHX 090304 EN-BFM	9,0	14,29	3,18	4,40	0,4	5056057		
	WCHX 090308 EN-BFM	9,0	14,29	3,18	4,40	0,8	5056058		
	WCHX 10T304 EN-BFM	10,0	15,87	3,97	5,90	0,4	5056059		
	WCHX 10T308 EN-BFM	10,0	15,87	3,97	5,90	0,8	5056060		
	WCHX 130508 EN-BFM	13,0	21,00	5,56	7,00	0,8	5056061		
WCHX...EN-BFM 	WCHX 040102 EN-BFM	4,0	6,35	1,59	2,25	0,2		5062986	
	WCHX 040104 EN-BFM	4,0	6,35	1,59	2,25	0,4		5063176	
	WCHX 05T102 EN-BFM	5,0	7,93	1,98	2,80	0,2		5063178	
	WCHX 05T104 EN-BFM	5,0	7,93	1,98	2,80	0,4		5063180	
	WCHX 060202 EN-BFM	5,5	8,37	2,38	2,80	0,2		5063184	
	WCHX 060204 EN-BFM	5,5	8,37	2,38	2,80	0,4		5063186	
	WCHX 070304 EN-BFM	7,5	12,00	3,18	3,40	0,4		5063315	
	WCHX 070308 EN-BFM	7,5	12,00	3,18	3,40	0,8		5063316	
	WCHX 090304 EN-BFM	9,0	14,29	3,18	4,40	0,4		5063317	
	WCHX 090308 EN-BFM	9,0	14,29	3,18	4,40	0,8		5063318	
	WCHX 10T304 EN-BFM	10,0	15,87	3,97	5,90	0,4		5063322	
	WCHX 10T308 EN-BFM	10,0	15,87	3,97	5,90	0,8		5063321	
	WCHX 130508 EN-BFM	13,0	21,00	5,56	7,00	0,8		5063319	

Bestellbeispiel Order example: 10 Stück 10 pieces WCHX 040102FN--BAL LW610

- Verfügbar ab Lager Available from stock

Sorte Grade	ISO	Anwendungsbereich Application range	Werkstoffgruppe Material group						Bearbeitungsverfahren Application					
			P Stahl Steel	M Rostfrei Stainless	K Grauguss Grey cast iron	N NE-Metalle (Al, etc.) Nonferrous metals	S Hochwarmfest High temperature materials	H Harte Werkstoffe Hard materials	T Drehen Turning	M Fräsen Milling	D Bohren Drilling	S Gewinde- bearbeitung Threading	G Einstechen Grooving	P Abstechen Parting
LCP25T	HC-P25		■						●		●			
	HC-M25			□					●		●			
LCM45T	HC-M40			■					●		●			
	HC-P40		■						●		●			
LW610	HW-K10					■			●		●			
Anwendungsschwerpunkt Application peak Gesamtbereich nach ISO 513 Full range to ISO 513			■ Hauptanwendung Main application □ Weitere Anwendung Further applications						● Standardsorte Standard grade					

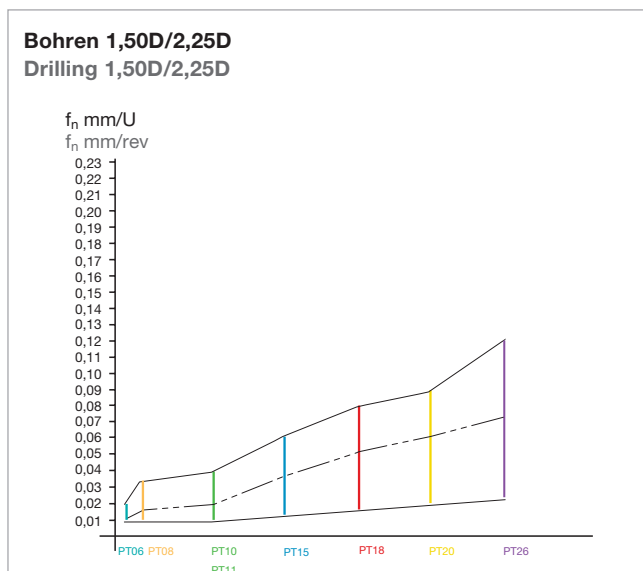
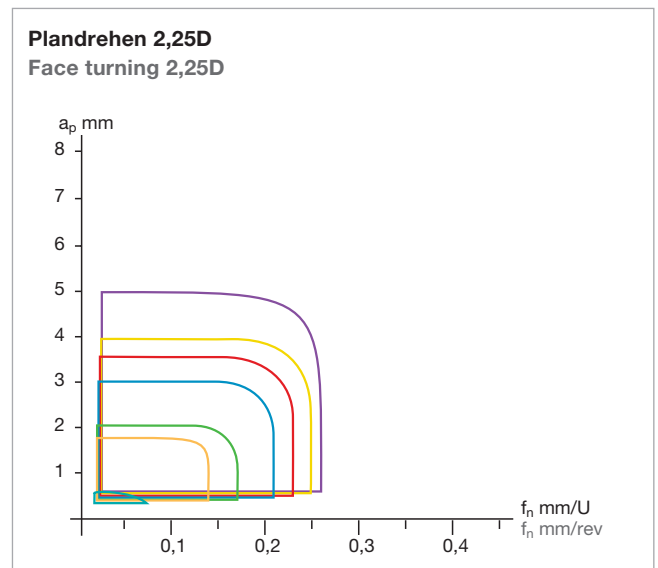
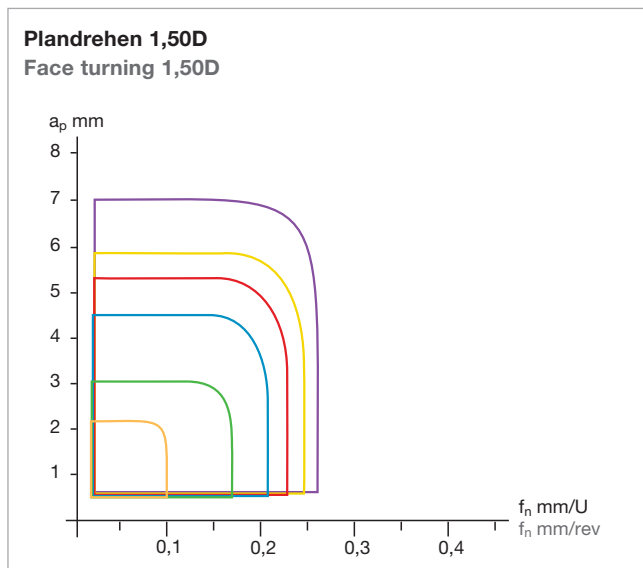
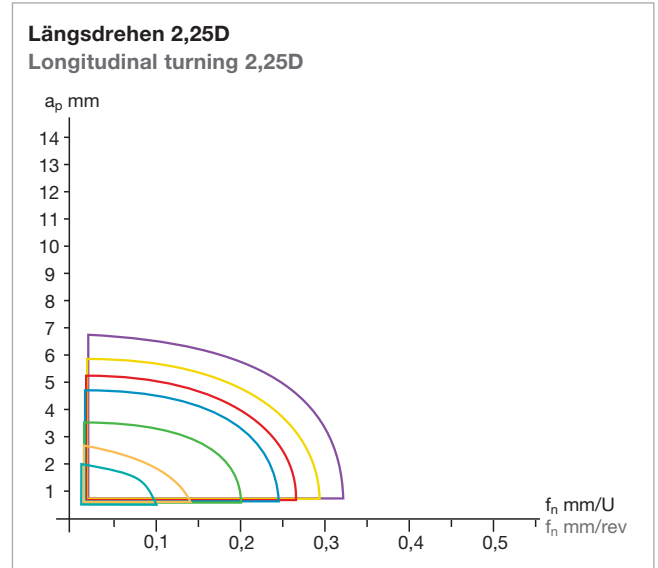
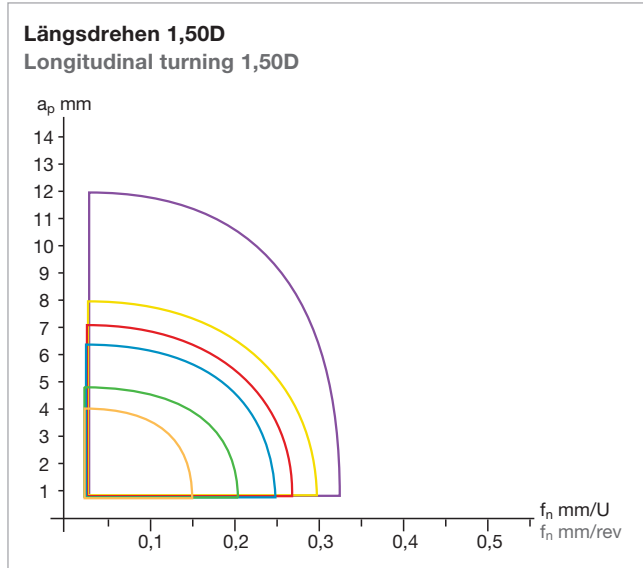

- = PT26
- = PT20
- = PT18
- = PT15
- = PT11
- = PT10
- = PT08
- = PT06¹⁾

¹⁾ Für Stahl, Rostfrei und Grauguss
For steel, stainless steel and grey cast iron

Verwenden Sie die Pentatec®-Werkzeuge immer mit Kühlung
Use Pentatec® tools always with coolant

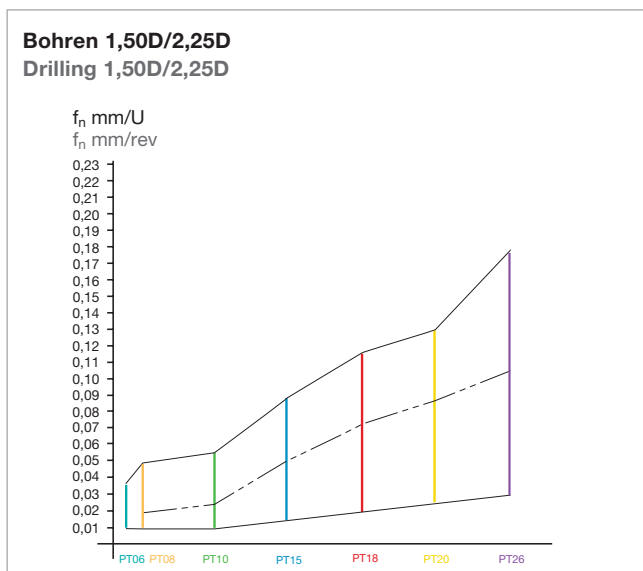
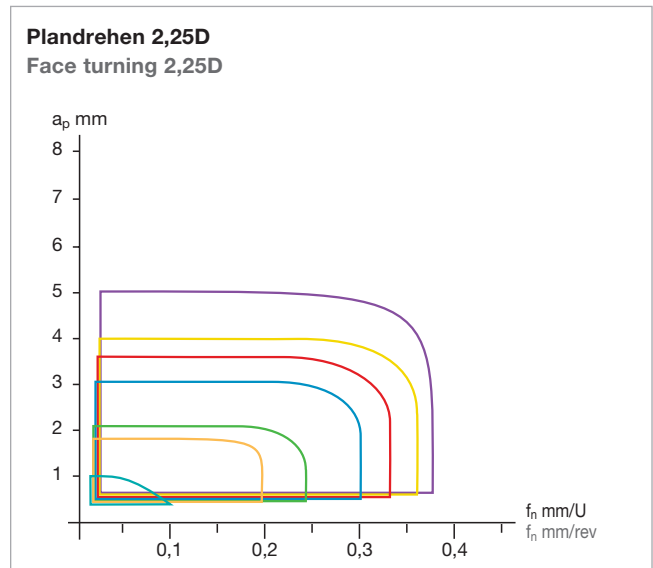
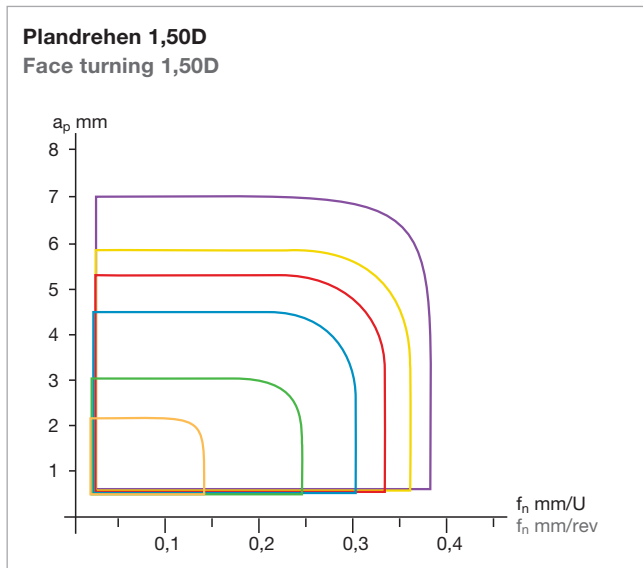
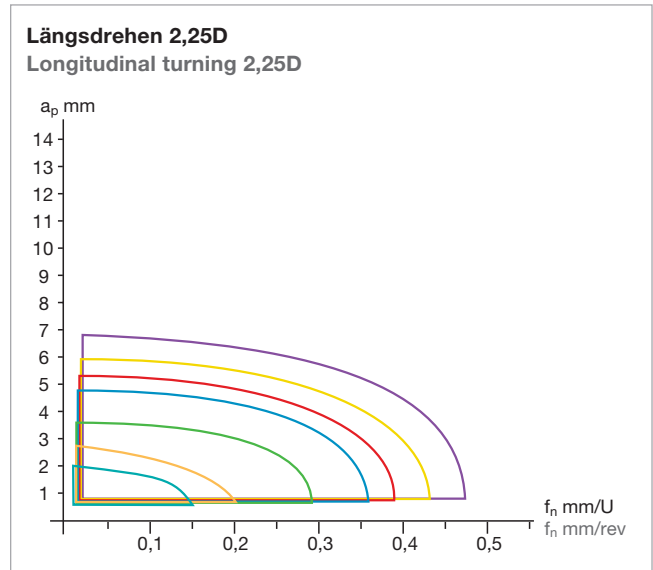
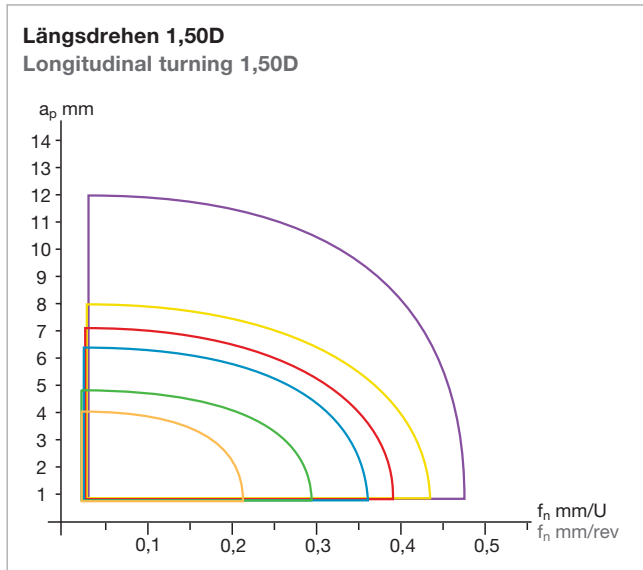

- = PT26
- = PT20
- = PT18
- = PT15
- = PT11
- = PT06
- = PT08

Verwenden Sie die Pentatec®-Werkzeuge immer mit Kühlung
Use Pentatec® tools always with coolant

Werkstoff Material	Brinell Härte Brinell hardness HB	Drehen und Bohren Turning and drilling v _c (m/min)			
		LCP25T	LCM45T	LW610	
P Unlegierter Baustahl ¹⁾ Unalloyed steel ¹⁾	ca. 0,15 %C geglüht annealed	125	170 – 300	120 – 250	
	ca. 0,45 %C geglüht annealed	190	150 – 255	100 – 200	
	ca. 0,45 %C vergütet hardened and temp.	250	100 – 200	70 – 180	
	ca. 0,75 %C geglüht annealed	270	110 – 185	70 – 180	
	ca. 0,75 %C vergütet hardened and temp.	300	90 – 160	50 – 150	
	Niedrig legierter Stahl ¹⁾ Low-alloy steel ¹⁾	geglüht annealed	180	120 – 240	80 – 200
		vergütet hardened and temp.	275	100 – 210	70 – 180
			300	100 – 185	100 – 185
			350	90 – 145	70 – 150
	Hochlegierter Stahl und hochlegierter Werkzeugstahl ¹⁾ High-alloy steel and high alloy tool steel ¹⁾	geglüht annealed	200	130 – 215	70 – 180
gehärtet und angelassen hardened and temp.		325	80 – 140	50 – 120	
Nichtrostender Stahl ¹⁾ Stainless steel ¹⁾	ferritisch/martensitisch geglüht ferritic/martensitic annealed	200	110 – 200	70 – 150	
	martensitisch vergütet martensitic hardened and temp.	240	100 – 160	70 – 120	
M Nichtrostender Stahl ¹⁾ Stainless steel ¹⁾	austenitisch ²⁾ , abgeschreckt austenitic ²⁾ , quenched	180	90 – 160	50 – 150	
K Grauguss Grey cast iron	perlitisch/ferritisch perlitic/ferritic	180		150 – 250	
	perlitisch (martensitisch) perlitic (martensitic)	260		100 – 150	
	Gusseisen mit Kugelgraphit Nodular graphite cast iron	ferritisch ferritic	160		130 – 80
	Temperguss Malleable cast iron	perlitisch perlitic	250		100 – 150
N Aluminium-Knetlegierungen Aluminium wrought alloys	nicht aushärtbar unhardenable	60		400 – 2400	
	aushärtbar, ausgehärtet hardenable, hardened	100		160 – 1600	
	Aluminium-Gusslegierungen Aluminium cast alloys	ca. 12 % Si. nicht aushärtbar ca. 12 % Si. unhardenable	75		320 – 1200
		ca. 12 % Si. aushärtbar, ausgehärtet ca. 12 % Si. hardenable, hardened	90		240 – 950
		> 12 % Si. nicht aushärtbar > 12 % Si. unhardenable	130		160 – 800
		Kupfer und Kupferlegierungen (Bronze/Messing) Copper and copper alloys (Bronze/Brass)	Automatenlegierung Pb > 1 % Free cutting alloys Pb > 1 %	110	
		Messing, Rotguss Brass, Red bronze	90		200 – 800
		Bronze, bleifreies Kupfer und Elektrolytkupfer Bronze, non leaded copper and electrolytic copper	100		120 – 320
	Nichtmetallische Werkstoffe Nonmetallic materials	Duroplaste Duroplastics			
		Faserverstärkte Kunststoffe Fibre reinforced plastics			
Hartgummi Hard rubber					
S Warmfeste Legierungen Heat resistant alloys	Fe-Basis Fe-based	gegüht annealed ausgehärtet hardened	200 280		
	Ni- oder Co-Basis Ni- or Co-based	gegüht annealed ausgehärtet hardened	250 350		
		gegossen cast	320		
	Titanlegierungen Titanium alloys	Reintitan Pure titanium	400 ³⁾		
		Alpha + Beta-Legierungen, ausgehärtet Alpha- and Beta-alloys hardened	1050 ³⁾		

¹⁾ und Stahlguss
and cast steel

²⁾ und austenitische/ferritische
and austenitic/ferritic

³⁾ R_m = Zugfestigkeit in N/mm²
R_m = Tensile strength in N/mm²

Nassbearbeitung
Wet machining

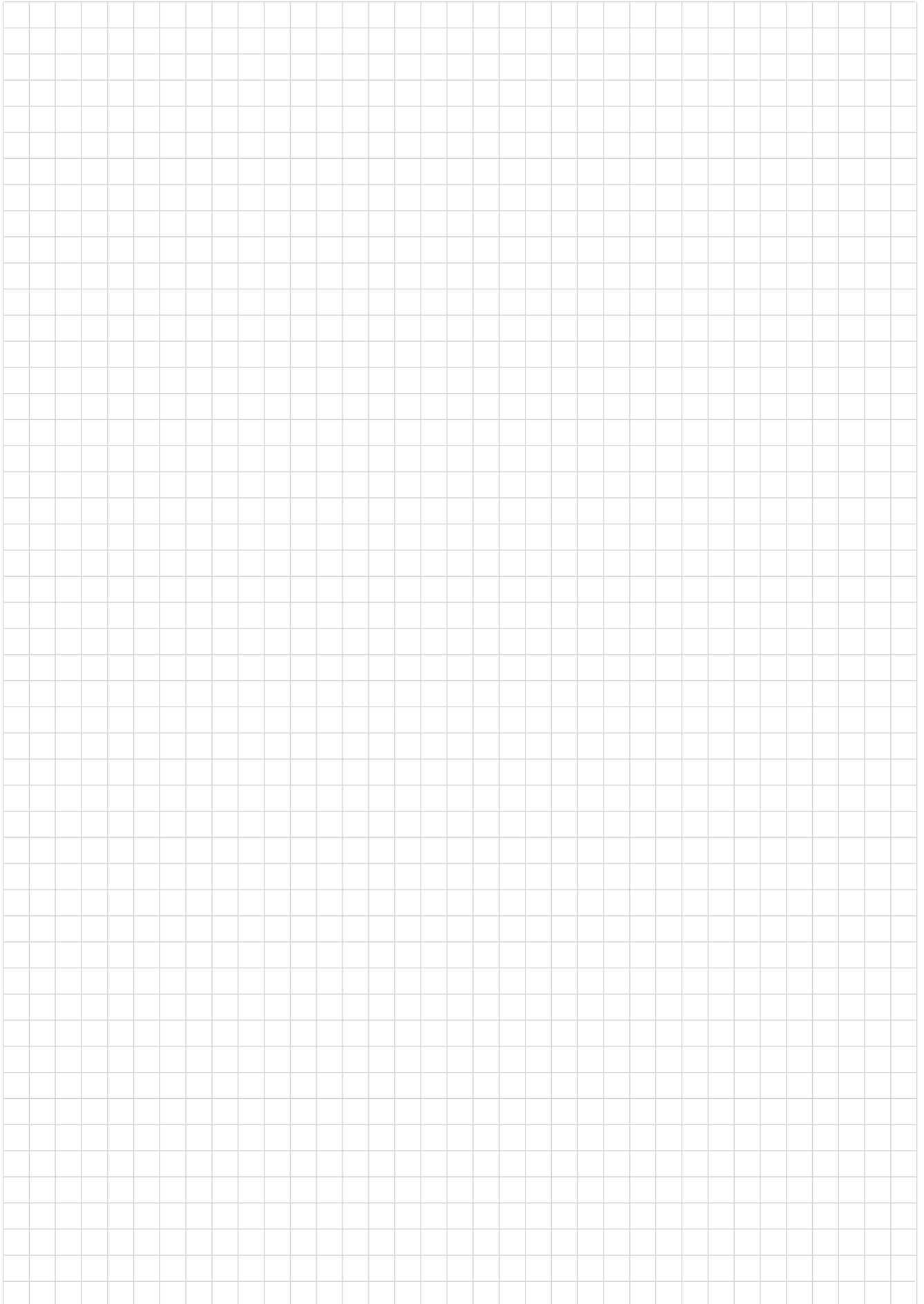

<p>Mutter/ St52 Nut</p> 	<p>Werkzeug: Tool: Pentatec® PTL15-1,50D-07</p> <p>Wendeplatte/Sorte: Insert/Grade: WCHX 070304EN-BFM/LCP25T</p> <p>Anwendungen: Applications: Bohren Drilling Längsdrehen Longitudinal turning</p> <p>Kühlung: Coolant: Emulsion Emulsion</p> <p>Schnittparameter: Cutting data: v_c 150 m/min 180 m/min a_p 1 mm f 0,07 mm/U rev 0,2 mm/U rev</p> <p>Ergebnis: Result: Reduzierung der Stückzeit um 30 % Ersatz von drei Werkzeugen Reduction of machining time by 30 % Three tools replaced</p>
<p>Flansch / Aluminium Flange / Aluminium</p> 	<p>Werkzeug: Tool: Pentatec® PTR20-1,50D-10</p> <p>Wendeplatte/Sorte: Insert/Grade: WCHX 10T308FN-BAL/LW610</p> <p>Anwendungen: Applications: Plandrehen Face turning Bohren Drilling</p> <p>Kühlung: Coolant: nass wet</p> <p>Schnittparameter: Cutting data: v_c 300 m/min 300 m/min a_p 2 mm f 0,15 mm/U rev 0,30 mm/U rev</p> <p>Ergebnis: Result: Reduzierung der Bearbeitungszeit um 50 % Reduction of machining time by 50 %</p>
<p>Buchse / St52 (SAE 1055) Bush</p> 	<p>Werkzeug: Tool: Pentatec® PTL20-1,50D-10</p> <p>Wendeplatte/Sorte: Insert/Grade: WCHX 10T304EN-BFM/LCP25T</p> <p>Anwendungen: Applications: Bohren Drilling Ausdrehen Boring</p> <p>Kühlung: Coolant: Emulsion Emulsion</p> <p>Schnittparameter: Cutting data: v_c 200 m/min 200 m/min a_p 1,5 mm f 0,03-0,05 mm/U rev 0,15 mm/U rev</p> <p>Ergebnis: Result: 25 % kürzere Bearbeitungszeit. Ersatz eines Werkzeuges. Einsparung eines Werkzeugwechselflatzes. Reduction of machining time by 25 %. One tool replaced. One tool place saved.</p>
<p>Schmiedeteil / St37 (SAE 1035) Forged piece</p> 	<p>Werkzeug: Tool: Pentatec® PTR20-1,50D-10</p> <p>Wendeplatte/Sorte: Insert/Grade: WCHX 10T304EN-BFM/LCP25T</p> <p>Anwendungen: Applications: Plandrehen, Bohren Face turning, drilling Ausdrehen Boring</p> <p>Kühlung: Cooling: Emulsion Emulsion</p> <p>Schnittparameter: Cutting data: v_c 180 m/min 180 m/min a_p 1 mm 2 mm f 0,06 mm/U rev 0,15 mm/U rev</p> <p>Ergebnis: Result: 25 % kürzere Bearbeitungszeit. Einsparung eines Bohrwerkzeuges. Reduction of machining time by 25 %. One drilling tool saved.</p>



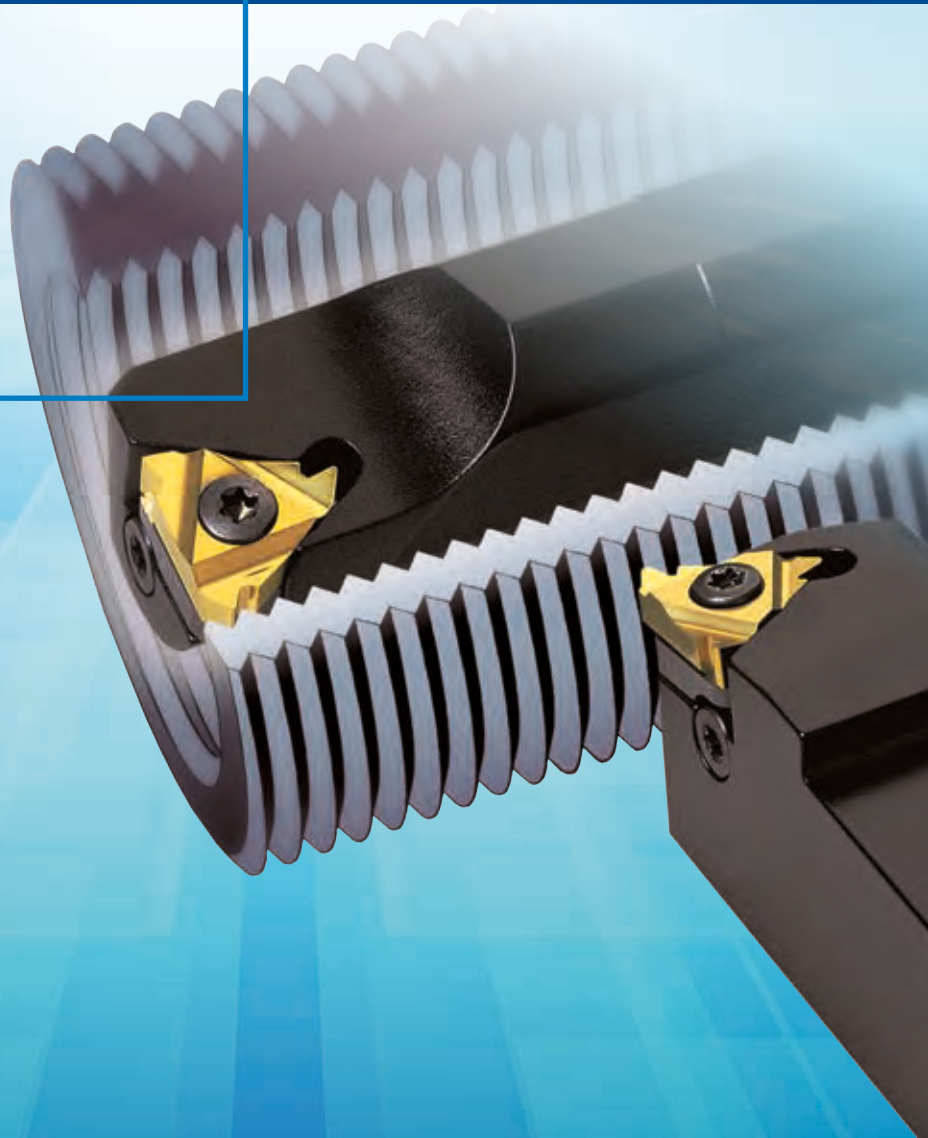

Gewindedrehen Thread turning

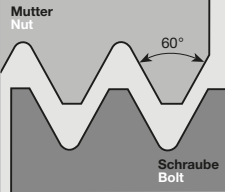
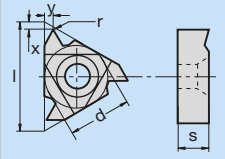

Wendeschneidplatten	Indexable inserts	151
Teilprofil	Partial profile	
A, AG, G, N: 55°, 60°	A, AG, G, N: 55°, 60°	151
Vollprofil	Full profile	
ISO-Metrisch	ISO Metric	153
BSP	BSP	155
Amerikanisch UN	American UN	157
BSPT	BSPT	161
NPT, NPTF	NPT, NPTF	162
Trapez DIN 103	Trapezoidal DIN 103	164
Klemmhalter, Ersatzteile	Tool holders, spare parts	166
Technische Hinweise	Technical hints	
Schneidstoffsorten, Übersicht	Turning grades, overview	169
Arbeitsmethoden beim Gewindedrehen	Thread turning methods	170
Flankenfreiwinkel	Flank clearance angle	170
Zustellungsmethoden	Infeed methods	171
Wahl der richtigen Unterlagsplatten	Choosing the correct anvil	171
Steigungswinkel	Helix angle	172
Unterlagsplatten	Anvils	172
Bearbeitungsbeispiele	Machining examples	173
Maßnahmen bei Bearbeitungsproblemen, Gewindedrehen	Options against machining problems, thread turning	174
Anzahl der Durchgänge	Number of passes	174
Schnittdatenrichtwerte, Gewindedrehen	Cutting data standard values, thread turning	175

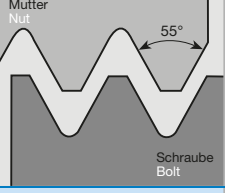
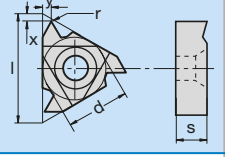
 Mutter Nut Schraube Bolt Teilprofil 60° Partial Profile 60°		Steigung Pitch		l	d	s	r	x	y	Sorte Grade			Unterlage Anvil	Passendes Werkzeug Suitable tool holder	Seite Page
		mm	Gang / Zoll tpi							LCP20T	LCM25T	LWN20T			
 Bestellbezeichnung Ordering Code		mm	Gang / Zoll tpi	l	d	s	r	x	y	LCP20T	LCM25T	LWN20T	Unterlage Anvil	Passendes Werkzeug Suitable tool holder	Seite Page
Rechts Right hand 	11ERA60	0,5-1,5	48-16	11	6,35	3,0	0,05	0,8	0,9	●	●	○	-	NL...-11	166
	16ERA60	0,5-1,5	48-16	16	9,52	3,4	0,05	0,8	0,9	●	●	○	YE16	AL...-16	166
	16ERAG60	0,5-3,0	48-8	16	9,52	3,4	0,06	1,2	1,7	●	●	○	YE16		
	16ERG60	1,75-3,0	14-8	16	9,52	3,4	0,25	1,2	1,7	●	●	○	YE16		
	22ERN60	3,5-5,0	7-5	22	12,70	4,6	0,51	1,7	2,5	●	●	○	YE22	AL...-22	166
Links Left hand 	11ELA60	0,5-1,5	48-16	11	6,35	3,0	0,05	0,8	0,9	●	●	○	-	NL...-11	166
	16ELA60	0,5-1,5	48-16	16	9,52	3,4	0,05	0,8	0,9	●	●	○	YI16	AL...-16	166
	16ELAG60	0,5-3,0	48-8	16	9,52	3,4	0,06	1,2	1,7	●	●	○	YI16		
	16ELG60	1,75-3,0	14-8	16	9,52	3,4	0,25	1,2	1,7	●	●	○	YI16		
	22ELN60	3,5-5,0	7-5	22	12,70	4,6	0,51	1,7	2,5	●	●	○	YI22	AL...-22	166

 Mutter Nut Schraube Bolt Teilprofil 55° Partial Profile 55°		Steigung Pitch		l	d	s	r	x	y	Sorte Grade			Unterlage Anvil	Passendes Werkzeug Suitable tool holder	Seite Page
		mm	Gang / Zoll tpi							LCP20T	LCM25T	LWN20T			
 Bestellbezeichnung Ordering Code		mm	Gang / Zoll tpi	l	d	s	r	x	y	LCP20T	LCM25T	LWN20T	Unterlage Anvil	Passendes Werkzeug Suitable tool holder	Seite Page
Rechts Right hand 	11ERA55	0,5-1,5	48-16	16	9,52	3,0	0,05	0,8	0,9	●	●	○	-	NL...-11	166
	16ERA55	0,5-1,5	48-16	16	9,52	3,4	0,05	0,8	0,9	●	●	○	YE16	AL...-16	166
	16ERG55	1,75-3,0	14-8	16	9,52	3,4	0,20	1,2	1,7	●	●	○	YE16		
	16ERAG55	0,5-3,0	48-8	16	9,52	3,4	0,07	1,2	1,7	●	●	○	YE16		
	22ERN55	3,5-5,0	7-5	22	12,70	4,6	0,43	1,7	2,5	●	●	○	YE22	AL...-22	166
Links Left hand 	11ELA55	0,5-1,5	48-16	16	9,52	3,0	0,05	0,8	0,9	●	●	○	-	NL...-11	166
	16ELA55	0,5-1,5	48-16	16	9,52	3,4	0,05	0,8	0,9	●	●	○	YI16	AL...-16	166
	16ELG55	1,75-3,0	14-8	16	9,52	3,4	0,20	1,2	1,7	●	●	○	YI16		
	16ELAG55	0,5-3,0	48-8	16	9,52	3,4	0,07	1,2	1,7	●	●	○	YI16		
	22ELN55	3,5-5,0	7-5	22	12,70	4,6	0,43	1,7	2,5	●	●	○	YI22	AL...-22	166

Bestellbeispiel Order example: 10 Stück pieces 11ERA60 LCP20T

● Verfügbar ab Lager
Available from stock

○ Auf Anfrage
Upon request

		Teilprofil 60° Partial Profile 60°										Sorte Grade			Unterlage Anvil	Passendes Werkzeug Suitable tool holder	Seite Page
		Steigung Pitch		l	d	s	r	x	y	LCP20T	LCM25T	LWN20T					
		mm	Gang / Zoll tpi							Bestellbezeichnung Ordering Code							
Rechts Right hand 	11IRA60	0,5-1,5	48-16	11	6,35	3,0	0,05	0,8	0,9	●	●	○	-	NVR..-11	166		
	16IRA60	0,5-1,5	48-16	16	9,52	3,4	0,05	0,8	0,9	●	●	○	YI16	AVR..-16	166		
	16IRG60	1,75-3,0	14-8	16	9,52	3,4	0,15	1,2	1,7	●	●	○	YI16	NVR..-16	166		
	16IRAG60	0,5-3,0	48-8	16	9,52	3,4	0,05	1,2	1,7	●	●	○	YI16				
	22IRN60	3,5-5,0	7-5	22	12,70	4,6	0,28	1,7	2,5	●	●	○	YI22	AVR..-22	166		
														NVR..-22	166		
Links Left hand 	11ILA60	0,5-1,5	48-16	11	6,35	3,0	0,05	0,8	0,9	●	●	○	-	NVR..-11	166		
	16ILA60	0,5-1,5	48-16	16	9,52	3,4	0,05	0,8	0,9	●	●	○	YE16	AVR..-16	166		
	16ILG60	1,75-3,0	14-8	16	9,52	3,4	0,15	1,2	1,7	●	●	○	YE16	NVR..-16	166		
	16ILAG60	0,5-3,0	48-8	16	9,52	3,4	0,05	1,2	1,7	●	●	○	YE16				
	22ILN60	3,5-5,0	7-5	22	12,70	4,6	0,28	1,7	2,5	●	●	○	YE22	AVR..-22	166		
														NVR..-22	166		

		Teilprofil 55° Partial Profile 55°										Sorte Grade			Unterlage Anvil	Passendes Werkzeug Suitable tool holder	Seite Page
		Steigung Pitch		l	d	s	r	x	y	LCP20T	LCM25T	LWN20T					
		mm	Gang / Zoll tpi							Bestellbezeichnung Ordering Code							
Rechts Right hand 	11IRA55	0,5-1,5	48-16	11	6,35	3,0	0,05	0,8	0,9	●	●	○	-	NVR..-11	166		
	16IRA55	0,5-1,5	48-16	16	9,52	3,4	0,05	0,8	0,9	●	●	○	YI16	AVR..-16	166		
	16IRG55	1,75-3,0	14-8	16	9,52	3,4	0,20	1,2	1,7	●	●	○	YI16	NVR..-16	166		
	16IRAG55	0,5-3,0	48-8	16	9,52	3,4	0,07	1,2	1,7	●	●	○	YI16				
	22IRN55	3,5-5,0	7-5	22	12,70	4,6	0,43	1,7	2,5	●	●	○	YI22	AVR..-22	166		
														NVR..-22			
Links Left hand 	11ILA55	0,5-1,5	48-16	11	6,35	3,0	0,05	0,8	0,9	●	●	○	-	NVR..-11	166		
	16ILA55	0,5-1,5	48-16	16	9,52	3,4	0,05	0,8	0,9	●	●	○	YE16	AVR..-16	166		
	16ILG55	1,75-3,0	14-8	16	9,52	3,4	0,20	1,2	1,7	●	●	○	YE16	NVR..-16	166		
	16ILAG55	0,5-3,0	48-8	16	9,52	3,4	0,07	1,2	1,7	●	●	○	YE16				
	22ILN55	3,5-5,0	7-5	22	12,70	4,6	0,43	1,7	2,5	●	●	○	YE22	AVR..-22	166		
														NVR..-22			

Bestellbeispiel Order example: 10 Stück pieces 11IRA60 LCP20T

● Verfügbar ab Lager
Available from stock

○ Auf Anfrage
Upon request

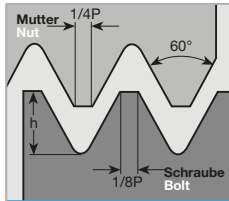

ISO-Metrisch Vollprofil
ISO-Metric Full Profile

	Bestellbezeichnung Ordering Code	Steigung Pitch		l	d	s	r	x	y	Sorte Grade			Unterlage Anvil	Passendes Werkzeug Suitable tool holder	Seite Page	
		mm	Gang / Zoll tpi							LCP20T	LCM25T	LWN20T				
Rechts Right hand 	11ER0,35ISO	0,35	-	11	6,35	3,0	-	0,8	0,4	●	●	○		NL...-11	166	
	11ER0,4ISO	0,40	-	11	6,35	3,0	-	0,7	0,4	●	●	○				
	11ER0,45ISO	0,45	-	11	6,35	3,0	-	0,7	0,4	●	●	○				
	11ER0,5ISO	0,5	-	11	6,35	3,0	-	0,6	0,4	●	●	○				
	11ER0,6ISO	0,6	-	11	6,35	3,0	-	0,6	0,6	●	●	○				
	11ER0,7ISO	0,7	-	11	6,35	3,0	-	0,6	0,6	●	●	○				
	11ER0,75ISO	0,75	-	11	6,35	3,0	-	0,6	0,6	●	●	○				
	11ER0,8ISO	0,8	-	11	6,35	3,0	-	0,6	0,6	●	●	○				
	11ER1,0ISO	1,0	-	11	6,35	3,0	-	0,7	0,7	●	●	○				
	11ER1,25ISO	1,25	-	11	6,35	3,0	-	0,8	0,9	●	●	○				
	11ER1,5ISO	1,5	-	11	6,35	3,0	-	0,8	1,0	●	●	○				
	16ER0,5ISO	0,5	-	16	9,52	3,4	-	0,6	0,4	●	●	○	YE16	AL...-16		166
	16ER0,75ISO	0,75	-	16	9,52	3,4	-	0,6	0,6	●	●	○	YE16			
	16ER1,0ISO	1,0	-	16	9,52	3,4	-	0,7	0,7	●	●	○	YE16			
	16ER1,25ISO	1,25	-	16	9,52	3,4	-	0,8	0,9	●	●	○	YE16			
	16ER1,5ISO	1,5	-	16	9,52	3,4	-	0,8	1,0	●	●	○	YE16			
	16ER1,75ISO	1,75	-	16	9,52	3,4	-	0,9	1,2	●	●	○	YE16			
	16ER2,0ISO	2,0	-	16	9,52	3,4	-	1,0	1,3	●	●	○	YE16			
	16ER2,5ISO	2,5	-	16	9,52	3,4	-	1,1	1,5	●	●	○	YE16			
	16ER3,0ISO	3,0	-	16	9,52	3,4	-	1,2	1,6	●	●	○	YE16			
	16ER3,5ISO	3,5	-	16	9,52	3,4	-	1,2	1,6	●	●	○	YE16			
	22ER3,5ISO	3,5	-	22	12,70	4,6	-	1,6	2,3	●	●	○	YE22	AL...-22		166
	22ER4,0ISO	4,0	-	22	12,70	4,6	-	1,6	2,3	●	●	○	YE22			
	22ER4,5ISO	4,5	-	22	12,70	4,6	-	1,7	2,4	●	●	○	YE22			
	22ER5,0ISO	5,0	-	22	12,70	4,6	-	1,7	2,5	●	●	○	YE22			
	27ER6,0ISO	6,0	-	27	15,88	6,2	-	1,8	2,5	●	●	○	YE27	AL...-27		
	Links Left hand 	11EL0,35ISO	0,35	-	11	6,35	3,0	-	0,8	0,4	●	●	○			NL...-11
11EL0,45ISO		0,45	-	11	6,35	3,0	-	0,7	0,4	●	●	○				
11EL0,5ISO		0,5	-	11	6,35	3,0	-	0,6	0,4	●	●	○				
11EL0,7ISO		0,7	-	11	6,35	3,0	-	0,6	0,6	●	●	○				
11EL0,75ISO		0,75	-	11	6,35	3,0	-	0,6	0,6	●	●	○				
11EL0,8ISO		0,8	-	11	6,35	3,0	-	0,6	0,6	●	●	○				
11EL1,0ISO		1,0	-	11	6,35	3,0	-	0,7	0,7	●	●	○				
11EL1,25ISO		1,25	-	11	6,35	3,0	-	0,8	0,9	●	●	○				
11EL1,5ISO		1,5	-	11	6,35	3,0	-	0,8	1,0	●	●	○				
16EL0,5ISO		0,5	-	16	9,52	3,4	-	0,6	0,4	●	●	○	YI16	AL...-16	166	
16EL0,75ISO		0,75	-	16	9,52	3,4	-	0,6	0,6	●	●	○	YI16			
16EL1,0ISO		1,0	-	16	9,52	3,4	-	0,7	0,7	●	●	○	YI16			
16EL1,25ISO		1,25	-	16	9,52	3,4	-	0,8	0,9	●	●	○	YI16			
16EL1,5ISO		1,5	-	16	9,52	3,4	-	0,8	1,0	●	●	○	YI16			
16EL1,75ISO		1,75	-	16	9,52	3,4	-	0,9	1,2	●	●	○	YI16			
16EL2,0ISO		2,0	-	16	9,52	3,4	-	1,0	1,3	●	●	○	YI16			
16EL2,5ISO		2,5	-	16	9,52	3,4	-	1,1	1,5	●	●	○	YI16			
16EL3,0ISO		3,0	-	16	9,52	3,4	-	1,2	1,6	●	●	○	YI16			
22EL3,5ISO		3,5	-	22	12,70	4,6	-	1,6	2,3	●	●	○	YI22	AL...-22		166
22EL4,0ISO		4,0	-	22	12,70	4,6	-	1,6	2,3	●	●	○	YI22			
22EL4,5ISO		4,5	-	22	12,70	4,6	-	1,7	2,4	●	●	○	YI22			
22EL5,0ISO		5,0	-	22	12,70	4,6	-	1,7	2,5	●	●	○	YI22			
27EL6,0ISO		6,0	-	27	15,88	6,2	-	1,7	2,5	●	●	○	YI27	AL...-27		

Bestellbeispiel Order example: 10 Stück pieces 11ER0,35ISO LCP20T

● Verfügbar ab Lager
Available from stock

○ Auf Anfrage
Upon request

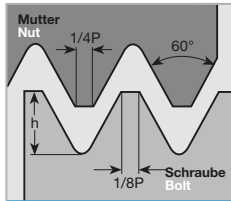

ISO-Metrisch Vollprofil
ISO-Metric Full Profile

	Bestellbezeichnung Ordering Code	Steigung Pitch		l	d	s	r	x	y	Sorte Grade			Unterlage Anvil	Passendes Werkzeug Suitable tool holder	Seite Page
		mm	Gang / Zoll tpi							LCP20T	LCM25T	LWN20T			
Rechts Right hand 	11IR0,35ISO	0,35	-	11	6,35	3,0	-	0,8	0,3	●	●	○	-	NVR...-11	166
	11IR0,45ISO	0,45	-	11	6,35	3,0	-	0,8	0,4	●	●	○			
	11IR0,6ISO	0,6	-	11	6,35	3,0	-	0,6	0,6	●	●	○			
	11IR0,7ISO	0,7	-	11	6,35	3,0	-	0,6	0,6	●	●	○			
	11IR0,75ISO	0,75	-	11	6,35	3,0	-	0,6	0,6	●	●	○			
	11IR0,8ISO	0,8	-	11	6,35	3,0	-	0,6	0,6	●	●	○			
	11IR1,0ISO	1,0	-	11	6,35	3,0	-	0,6	0,7	●	●	○	-		
	11IR1,25ISO	1,25	-	11	6,35	3,0	-	0,8	0,9	●	●	○			
	11IR1,5ISO	1,5	-	11	6,35	3,0	-	0,8	1,0	●	●	○	-		
	16IR1,0ISO	1,0	-	16	9,52	3,4	-	0,6	0,7	●	●	○	YI16	AVR...-16	166
	16IR1,25ISO	1,25	-	16	9,52	3,4	-	0,8	0,9	●	●	○	YI16	NVR...-16	166
	16IR1,50ISO	1,50	-	16	9,52	3,4	-	0,8	1,0	●	●	○	YI16		
	16IR1,75ISO	1,75	-	16	9,52	3,4	-	0,9	1,2	●	●	○	YI16		
	16IR2,0ISO	2,0	-	16	9,52	3,4	-	1,0	1,3	●	●	○	YI16		
	16IR2,5ISO	2,5	-	16	9,52	3,4	-	1,1	1,5	●	●	○	YI16		
	16IR3,0ISO	3,0	-	16	9,52	3,4	-	1,1	1,5	●	●	○	YI16		
	16IR3,5ISO	3,5	-	16	9,52	3,4	-	1,2	1,5	●	●	○	YI16		
	22IR3,5ISO	3,5	-	22	12,70	4,6	-	1,6	2,3	●	●	○	YI22	AVR...-22	166
	22IR4,0ISO	4,0	-	22	12,70	4,6	-	1,6	2,3	●	●	○	YI22	NVR...-22	166
	22IR4,5ISO	4,5	-	22	12,70	4,6	-	1,6	2,4	●	●	○	YI22		
22IR5,0ISO	5,0	-	27	12,70	4,6	-	1,6	2,3	●	●	○	YI22			
27IR6,0ISO	6,0	-	27	15,88	6,2	-	1,8	2,5	●	●	○	YI27	AVR...-27	166	
													NVR...-27	166	
Links Left hand 	11IL0,35ISO	0,35	-	11	6,35	3,0	-	0,8	0,3	●	●	○	-	NVR...-11	166
	11IL0,7ISO	0,7	-	11	6,35	3,0	-	0,6	0,6	●	●	○			
	11IL0,8ISO	0,8	-	11	6,35	3,0	-	0,6	0,6	●	●	○			
	11IL1,0ISO	1,0	-	11	6,35	3,0	-	0,6	0,7	●	●	○	-		
	16IL1,0ISO	1,0	-	16	9,52	3,4	-	0,6	0,7	●	●	○	YE16	AVR...-16	166
	16IL1,25ISO	1,25	-	16	9,52	3,4	-	0,8	0,9	●	●	○	YE16	NVR...-16	166
	16IL1,50ISO	1,50	-	16	9,52	3,4	-	0,8	1,0	●	●	○	YE16		
	16IL1,75ISO	1,75	-	16	9,52	3,4	-	0,9	1,2	●	●	○	YE16		
	16IL2,0ISO	2,0	-	16	9,52	3,4	-	1,0	0,6	●	●	○	YE16		
	16IL0,8ISO	0,8	-	16	9,52	3,4	-	0,6	1,3	●	●	○	YE16		
	16IL2,5ISO	2,5	-	16	9,52	3,4	-	1,1	1,5	●	●	○	YE16		
	16IL3,0ISO	3,0	-	16	9,52	3,4	-	1,2	1,5	●	●	○	YE16		
	16IL3,5ISO	3,5	-	16	9,52	3,4	-	1,1	1,5	●	●	○	YE16		
	22IL3,5ISO	3,5	-	22	12,70	4,6	-	1,6	2,3	●	●	○	YE22	AVR...-22	166
	22IL4,0ISO	4,0	-	22	12,70	4,6	-	1,6	2,3	●	●	○	YE22	NVR...-22	166
	22IL4,5ISO	4,5	-	22	12,70	4,6	-	1,6	2,4	●	●	○	YE22		
	22IL5,0ISO	5,0	-	22	12,70	4,6	-	1,6	2,3	●	●	○	YE22		
	27IL6,0ISO	6,0	-	27	15,88	6,2	-	1,8	2,5	●	●	○	YE27	AVR...-27	166
													NVR...-27	166	



Bestellbeispiel Order example: 10 Stück pieces 11IR0,35ISO LCP20T

● Verfügbar ab Lager
Available from stock

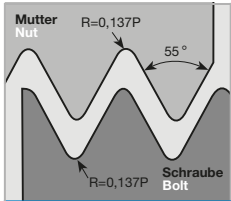

○ Auf Anfrage
Upon request

Wendeschneidplatten - Außengewinde
Indexable inserts - external threads

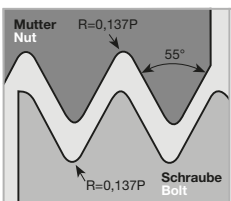

		Steigung Pitch									Sorte Grade			Unterlage Anvil	Passendes Werkzeug Suitable tool holder	Seite Page
		mm	Gang / Zoll tpi	l	d	s	r	x	y	LCP20T	LCM25T	LWN20T				
Rechts Right hand 	Bestellbezeichnung Ordering Code															
	11ER28W	-	28	11	6,35	3,0	-	0,6	0,7	●	●	○		NL...-11	166	
	11ER19W	-	19	11	6,35	3,0	-	0,8	1,0	●	●	○				
	11ER14W	-	14	11	6,35	3,0	-	1,0	1,2	●	●	○				
	16ER28W	-	28	16	9,52	3,4	-	0,6	0,7	●	●	○	YE16	AL...-16	166	
	16ER19W	-	19	16	9,52	3,4	-	0,8	1,0	●	●	○	YE16			
	16ER14W	-	14	16	9,52	3,4	-	1,0	1,2	●	●	○	YE16			
16ER11W	-	11	16	9,52	3,4	-	1,1	1,5	●	●	○	YE16				

Wendeschneidplatten - Innengewinde
Indexable inserts - internal threads

		Steigung Pitch									Sorte Grade			Unterlage Anvil	Passendes Werkzeug Suitable tool holder	Seite Page
		mm	Gang / Zoll tpi	l	d	s	r	x	y	LCP20T	LCM25T	LWN20T				
Rechts Right hand 	Bestellbezeichnung Ordering Code															
	11IR28W	-	28	11	6,35	3,0	-	0,6	0,7	●	●	○	-	NVR...-11	166	
	11IR19W	-	19	11	6,35	3,0	-	0,8	1,0	●	●	○	-			
	11IR14W	-	14	11	6,35	3,0	-	0,9	1,1	●	●	○	-			
	16IR28W	-	28	16	9,52	3,4	-	0,6	0,7	●	●	○	YI16	AVR...-16	166	
	16IR19W	-	19	16	9,52	3,4	-	0,8	1,0	●	●	○	YI16	NVR...-16	166	
	16IR14W	-	14	16	9,52	3,4	-	1,0	1,2	●	●	○	YI16			
16IR11W	-	11	16	9,52	3,4	-	1,1	1,5	●	●	○	YI16				



Bestellbeispiel Order example: 10 Stück pieces 11ER28W LCP20T

● Verfügbar ab Lager
 Available from stock

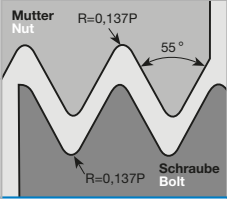

○ Auf Anfrage
 Upon request

Wendeschneidplatten - Außengewinde
Indexable inserts - external threads

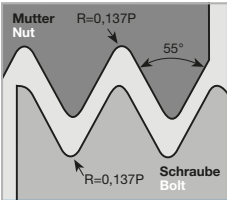

		Steigung Pitch									Sorte Grade			Unterlage Anvil	Passendes Werkzeug Suitable tool holder	Seite Page
		mm	Gang / Zoll tpi	l	d	s	r	x	y	LCP20T	LCM25T	LWN20T				
Links Left hand 	Bestellbezeichnung Ordering Code															
	16EL28W	-	28	16	9,52	3,4	-	0,6	0,7	○	○	○	YI16	AL...-16	166	
	16EL19W	-	19	16	9,52	3,4	-	0,8	1,0	○	○	○	YI16			
	16EL14W	-	14	16	9,52	3,4	-	1,0	1,2	○	○	○	YI16			
	16EL11W	-	11	16	9,52	3,4	-	1,1	1,5	○	○	○	YI16			

Wendeschneidplatten - Innengewinde
Indexable inserts - internal threads

		Steigung Pitch									Sorte Grade			Unterlage Anvil	Passendes Werkzeug Suitable tool holder	Seite Page
		mm	Gang / Zoll tpi	l	d	s	r	x	y	LCP20T	LCM25T	LWN20T				
Links Left hand 	Bestellbezeichnung Ordering Code															
	11IL19W	-	19	11	6,35	3,0	-	0,8	1,0	○	○	○	-	NVR...-11	166	
	11IL14W	-	14	11	6,35	3,0	-	0,9	1,1	○	○	○	-			
	16L28W	-	28	16	9,52	3,4	-	0,6	0,7		○	○	YE16	AVR...-16 NVR...-16	166	
	16L19W	-	19	16	9,52	3,4	-	0,8	1,0	○	○	○	YE16			
	16L14W	-	14	16	9,52	3,4	-	1,0	1,2	○	○	○	YE16			
16L11W	-	11	16	9,52	3,4	-	1,1	1,5	○	○	○	YE16				

Bestellbeispiel Order example: 10 Stück pieces 16EL28W LCP20T

● Verfügbar ab Lager
Available from stock

○ Auf Anfrage
Upon request

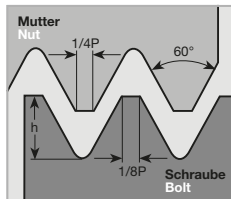

Amerikanisch UN Vollprofil
American UN Full Profile

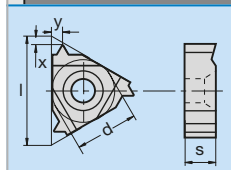

Bestellbezeichnung Ordering Code	Steigung Pitch		l	d	s	r	x	y	Sorte Grade			Unterlage Anvil	Passendes Werkzeug Suitable tool holder	Seite Page
	mm	Gang / Zoll tpi							LCP20T	LCM25T	LWM20T			
Rechts Right hand	-	72	16	9,52	3,4	-	0,8	0,4	○	○	○	YE16	AL...-16	166
	-	64	16	9,52	3,4	-	0,8	0,4	○	○	○	YE16		
	-	56	16	9,52	3,4	-	0,7	0,4	○	○	○	YE16		
	-	48	16	9,52	3,4	-	0,6	0,6	○	○	○	YE16		
	-	44	16	9,52	3,4	-	0,6	0,6	○	○	○	YE16		
	-	40	16	9,52	3,4	-	0,6	0,6	○	○	○	YE16		
	-	36	16	9,52	3,4	-	0,6	0,6	○	○	○	YE16		
	-	32	16	9,52	3,4	-	0,6	0,6	○	○	○	YE16		
	-	28	16	9,52	3,4	-	0,6	0,7	○	○	○	YE16		
	-	27	16	9,52	3,4	-	0,7	0,8	○	○	○	YE16		
	-	24	16	9,52	3,4	-	0,7	0,8	○	○	○	YE16		
	-	20	16	9,52	3,4	-	0,8	0,9	○	○	○	YE16		
	-	18	16	9,52	3,4	-	0,8	1	○	○	○	YE16		
	-	16	16	9,52	3,4	-	0,9	1,1	○	○	○	YE16		
	-	14	16	9,52	3,4	-	1	1,2	○	○	○	YE16		
	-	13	16	9,52	3,4	-	1	1,3	○	○	○	YE16		
	-	12	16	9,52	3,4	-	1,1	1,4	○	○	○	YE16		
	-	11	16	9,52	3,4	-	1,1	1,5	○	○	○	YE16		
	-	10	16	9,52	3,4	-	1,1	1,5	○	○	○	YE16		
	-	9	16	9,52	3,4	-	1,2	1,7	○	○	○	YE16		
	-	8	16	9,52	3,4	-	1,2	1,6	○	○	○	YE16		
	-	7	22	12,70	4,6	-	1,6	2,3	○	○	○	YE22	AL...-22	166
	-	6	22	12,70	4,6	-	1,6	2,3	○	○	○	YE22		
	-	5	22	12,70	4,6	-	1,7	2,5	○	○	○	YE22		

Bestellbeispiel Order example: 10 Stück piece 16ER72UN LCP20T

● Verfügbar ab Lager
Available from stock

○ Auf Anfrage
Upon request

		Amerikanisch UN Vollprofil American UN Full Profile										Steigung Pitch mm Gang / Zoll tpi			Sorte Grade			Unterlage Anvil	Passendes Werkzeug Suitable tool holder	Seite Page
		Bestellbezeichnung Ordering Code	mm	Gang / Zoll tpi	l	d	s	r	x	y	LCP20T				LCM25T	LVN20T				
Rechts Right hand 	111R72UN	-	72	11	6,35	3,0	-	0,8	0,3									NVR..-11	166	
	111R64UN	-	64	11	6,35	3,0	-	0,8	0,4	○	○	○								
	111R56UN	-	56	11	6,35	3,0	-	0,7	0,4	○	○	○								
	111R48UN	-	48	11	6,35	3,0	-	0,6	0,6	○	○	○								
	111R40UN	-	40	11	6,35	3,0	-	0,6	0,6	○	○	○								
	111R36UN	-	36	11	6,35	3,0	-	0,6	0,6	○	○	○								
	111R32UN	-	32	11	6,35	3,0	-	0,6	0,6	○	○	○								
	111R28UN	-	28	11	6,35	3,0	-	0,6	0,7	○	○	○								
	111R27UN	-	27	11	6,35	3,0	-	0,7	0,8	○	○	○								
	111R24UN	-	24	11	6,35	3,0	-	0,7	0,8	○	○	○								
	111R20UN	-	20	11	6,35	3,0	-	0,8	0,9	○	○	○								
	111R18UN	-	18	11	6,35	3,0	-	0,8	1,0	○	○	○								
	111R16UN	-	16	11	6,35	3,0	-	0,9	1,1	○	○	○								
	111R14UN	-	14	11	6,35	3,0	-	0,9	1,1	○	○	○								
	161R56UN	-	56	16	9,52	3,4	-	0,7	0,4			○	YI16	AVR..-16	166					
	161R48UN	-	48	16	9,52	3,4	-	0,6	0,6	○	○	○	YI16	NVR..-16						
	161R44UN	-	44	16	9,52	3,4	-	0,6	0,6	○	○	○	YI16							
	161R40UN	-	40	16	9,52	3,4	-	0,6	0,6	○	○	○	YI16							
	161R36UN	-	36	16	9,52	3,4	-	0,6	0,6	○	○	○	YI16							
	161R32UN	-	32	16	9,52	3,4	-	0,6	0,6	○	○	○	YI16							
161R28UN	-	28	16	9,52	3,4	-	0,6	0,7	○	○	○	YI16								
161R27UN	-	27	16	9,52	3,4	-	0,7	0,8	○	○	○	YI16								
161R24UN	-	24	16	9,52	3,4	-	0,7	0,8	○	○	○	YI16								
161R20UN	-	20	16	9,52	3,4	-	0,8	0,9	○	○	○	YI16								
161R18UN	-	18	16	9,52	3,4	-	0,8	1,0	○	○	○	YI16								
161R16UN	-	16	16	9,52	3,4	-	0,9	1,1	○	○	○	YI16								
161R14UN	-	14	16	9,52	3,4	-	0,9	1,2	○	○	○	YI16								
161R13UN	-	13	16	9,52	3,4	-	1,0	1,3	○	○	○	YI16								
161R12UN	-	12	16	9,52	3,4	-	1,1	1,4	○	○	○	YI16								
161R11,5UN	-	11,5	16	9,52	3,4	-	1,1	1,5	○	○	○	YI16								
161R11UN	-	11	16	9,52	3,4	-	1,1	1,5	○	○	○	YI16								
161R10UN	-	10	16	9,52	3,4	-	1,1	1,5	○	○	○	YI16								
161R9UN	-	9	16	9,52	3,4	-	1,2	1,7	○	○	○	YI16								
161R8UN	-	8	16	9,52	3,4	-	1,1	1,5	○	○	○	YI16								
221R7UN	-	7	22	12,70	4,6	-	1,6	2,3	○	○	○	YI22	AVR..-22	166						
221R6UN	-	6	22	12,70	4,6	-	1,6	2,3	○	○	○	YI22	NVR..-22							
221R5UN	-	5	22	12,70	4,6	-	1,6	2,3	○	○	○	YI22								

Bestellbeispiel Order example: 10 Stück pieces 111R72UN LCP20T

● Verfügbar ab Lager
Available from stock

○ Auf Anfrage
Upon request

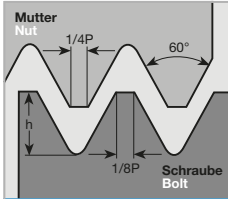

Amerikanisch UN Vollprofil
American UN Full Profile

	Bestellbezeichnung Ordering Code	Steigung Pitch		l	d	s	r	x	y	Sorte Grade			Unterlage Anvil	Passendes Werkzeug Suitable tool holder	Seite Page
		mm	Gang / Zoll tpi							LCP20T	LCM25T	LWN20T			
Links Left hand 	16EL56UN	-	56	16	9,52	3,4	-	0,7	0,4	<input type="radio"/>	<input type="radio"/>	<input type="radio"/>	YI16	AL...-16	166
	16EL48UN	-	48	16	9,52	3,4	-	0,6	0,6	<input type="radio"/>	<input type="radio"/>	<input type="radio"/>	YI16		
	16EL44UN	-	44	16	9,52	3,4	-	0,6	0,6	<input type="radio"/>	<input type="radio"/>	<input type="radio"/>	YI16		
	16EL40UN	-	40	16	9,52	3,4	-	0,6	0,6	<input type="radio"/>	<input type="radio"/>	<input type="radio"/>	YI16		
	16EL36UN	-	36	16	9,52	3,4	-	0,6	0,6	<input type="radio"/>	<input type="radio"/>	<input type="radio"/>	YI16		
	16EL32UN	-	32	16	9,52	3,4	-	0,6	0,6	<input type="radio"/>	<input type="radio"/>	<input type="radio"/>	YI16		
	16EL28UN	-	28	16	9,52	3,4	-	0,6	0,7	<input type="radio"/>	<input type="radio"/>	<input type="radio"/>	YI16		
	16EL27UN	-	27	16	9,52	3,4	-	0,7	0,8	<input type="radio"/>	<input type="radio"/>	<input type="radio"/>	YI16		
	16EL24UN	-	24	16	9,52	3,4	-	0,7	0,8	<input type="radio"/>	<input type="radio"/>	<input type="radio"/>	YI16		
	16EL20UN	-	20	16	9,52	3,4	-	0,8	0,9	<input type="radio"/>	<input type="radio"/>	<input type="radio"/>	YI16		
	16EL18UN	-	18	16	9,52	3,4	-	0,8	1,0	<input type="radio"/>	<input type="radio"/>	<input type="radio"/>	YI16		
	16EL16UN	-	16	16	9,52	3,4	-	0,9	1,1	<input type="radio"/>	<input type="radio"/>	<input type="radio"/>	YI16		
	16EL14UN	-	14	16	9,52	3,4	-	1,0	1,2	<input type="radio"/>	<input type="radio"/>	<input type="radio"/>	YI16		
	16EL13UN	-	13	16	9,52	3,4	-	1,0	1,3	<input type="radio"/>	<input type="radio"/>	<input type="radio"/>	YI16		
	16EL12UN	-	12	16	9,52	3,4	-	1,1	1,4	<input type="radio"/>	<input type="radio"/>	<input type="radio"/>	YI16		
	16EL11UN	-	11	16	9,52	3,4	-	1,1	1,5	<input type="radio"/>	<input type="radio"/>	<input type="radio"/>	YI16		
	16EL10UN	-	10	16	9,52	3,4	-	1,1	1,5	<input type="radio"/>	<input type="radio"/>	<input type="radio"/>	YI16		
	16EL9UN	-	9	16	9,52	3,4	-	1,2	1,7	<input type="radio"/>	<input type="radio"/>	<input type="radio"/>	YI16		
	16EL8UN	-	8	16	9,52	3,4	-	1,2	1,6	<input type="radio"/>	<input type="radio"/>	<input type="radio"/>	YI16		
	22EL7UN	-	7	22	12,70	4,6	-	1,6	2,3	<input type="radio"/>	<input type="radio"/>	<input type="radio"/>	YI22		
22EL6UN	-	6	22	12,70	4,6	-	1,6	2,3	<input type="radio"/>	<input type="radio"/>	<input type="radio"/>	YI22			
22EL5UN	-	5	22	12,70	4,6	-	1,7	2,5	<input type="radio"/>	<input type="radio"/>	<input type="radio"/>	YI22			

Bestellbeispiel Order example: 10 Stück pieces 16EL56UN LWN20T

● Verfügbar ab Lager
Available from stock

○ Auf Anfrage
Upon request

		Amerikanisch UN Vollprofil American UN Full Profile										Sorte Grade			Unterlage Anvil	Passendes Werkzeug Suitable tool holder	Seite Page
		Steigung Pitch		l	d	s	r	x	y	LCP20T	LCM25T	LWN20T					
		Bestellbezeichnung Ordering Code	mm										Gang / Zoll tpi				
Links Left hand 	11IL32UN	-	32	11	6,35	3,0	-	0,6	0,6	○	○	○	-	NVR...-11	166		
	11IL28UN	-	28	11	6,35	3,0	-	0,6	0,7	○	○	○	-				
	11IL24UN	-	24	11	6,35	3,0	-	0,7	0,8	○	○	○	-				
	11IL20UN	-	20	11	6,35	3,0	-	0,8	0,9	○	○	○	-				
	11IL18UN	-	18	11	6,35	3,0	-	0,8	1,0	○	○	○	-				
	11IL16UN	-	16	11	6,35	3,0	-	0,9	1,1	○	○	○	-				
	16IL48UN	-	48	16	9,52	3,4	-	0,6	0,6	○	○	○	YE16	AVR...-16	166		
	16IL44UN	-	44	16	9,52	3,4	-	0,6	0,6	○	○	○	YE16	NVR...-16	166		
	16IL40UN	-	40	16	9,52	3,4	-	0,6	0,6	○	○	○	YE16				
	16IL36UN	-	36	16	9,52	3,4	-	0,6	0,6	○	○	○	YE16				
	16IL32UN	-	32	16	9,52	3,4	-	0,6	0,6	○	○	○	YE16				
	16IL28UN	-	28	16	9,52	3,4	-	0,6	0,7	○	○	○	YE16				
	16IL27UN	-	27	16	9,52	3,4	-	0,7	0,8	○	○	○	YE16				
	16IL24UN	-	24	16	9,52	3,4	-	0,7	0,8	○	○	○	YE16				
	16IL20UN	-	20	16	9,52	3,4	-	0,8	0,9	○	○	○	YE16				
	16IL18UN	-	18	16	9,52	3,4	-	0,8	1,0	○	○	○	YE16				
	16IL16UN	-	16	16	9,52	3,4	-	0,9	1,1	○	○	○	YE16				
	16IL14UN	-	14	16	9,52	3,4	-	0,9	1,2	○	○	○	YE16				
	16IL13UN	-	13	16	9,52	3,4	-	1,0	1,3	○	○	○	YE16				
	16IL12UN	-	12	16	9,52	3,4	-	1,1	1,4	○	○	○	YE16				
	16IL11UN	-	11	16	9,52	3,4	-	1,1	1,5	○	○	○	YE16				
	16IL10UN	-	10	16	9,52	3,4	-	1,1	1,5	○	○	○	YE16				
	16IL9UN	-	9	16	9,52	3,4	-	1,2	1,7	○	○	○	YE16				
	16IL8UN	-	8	16	9,52	3,4	-	1,1	1,5	○	○	○	YE16				
	22IL7UN	-	7	22	12,70	4,6	-	1,6	2,3	○	○	○	YE22			AVR...-22	166
	22IL6UN	-	6	22	12,70	4,6	-	1,6	2,3	○	○	○	YE22	NVR...-22	166		
	22IL5UN	-	5	22	12,70	4,6	-	1,6	2,3	○	○	○	YE22				



Bestellbeispiel Order example: 10 Stück pieces 11IL32UN LCP20T

● Verfügbar ab Lager
Available from stock

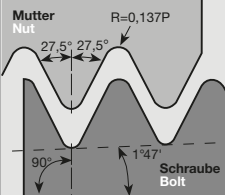

○ Auf Anfrage
Upon request

Wendeschneidplatten - Außengewinde Indexable inserts - external threads



		Steigung Pitch									Sorte Grade			Unterlage Anvil	Passendes Werkzeug Suitable tool holder	Seite Page
		mm	Gang / Zoll tpi	l	d	s	r	x	y	LCP20T	LCM25T	LWN20T				
Rechts Right hand 	16ER28BSPT	-	28	16	9,52	3,4	-	0,6	0,6	<input type="radio"/>	<input type="radio"/>	<input type="radio"/>	YE16	AL...-16	166	
	16ER19BSPT	-	19	16	9,52	3,4	-	0,8	0,9	<input type="radio"/>	<input type="radio"/>	<input type="radio"/>	YE16		166	
	16ER14BSPT	-	14	16	9,52	3,4	-	1,0	1,2	<input type="radio"/>	<input type="radio"/>	<input type="radio"/>	YE16			
	16ER11BSPT	-	11	16	9,52	3,4	-	1,1	1,5	<input type="radio"/>	<input type="radio"/>	<input type="radio"/>	YE16			
Links Left hand 	16EL14BSPT	-	14	16	9,52	3,4	-	1,0	1,2	<input type="radio"/>	<input type="radio"/>	<input type="radio"/>	YI16	AL...-16	166	
	16EL11BSPT	-	11	16	9,52	3,4	-	1,1	1,5	<input type="radio"/>	<input type="radio"/>	<input type="radio"/>	YI16			

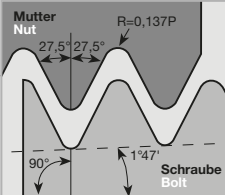

Wendeschneidplatten - Innengewinde Indexable inserts - internal threads



		Steigung Pitch									Sorte Grade			Unterlage Anvil	Passendes Werkzeug Suitable tool holder	Seite Page
		mm	Gang / Zoll tpi	l	d	s	r	x	y	LCP20T	LCM25T	LWN20T				
Rechts Right hand 	11IR19BSPT	-	19	11	6,35	3,0	-	0,8	0,9	<input type="radio"/>	<input type="radio"/>	<input type="radio"/>	-	NVR...-11	166	
	11IR14BSPT	-	14	11	6,35	3,0	-	0,9	1,0	<input type="radio"/>	<input type="radio"/>	<input type="radio"/>	-			
	16IR28BSPT	-	28	16	9,52	3,4	-	0,6	0,6	<input type="radio"/>	<input type="radio"/>	<input type="radio"/>	YI16	AVR...-16	166	
	16IR19BSPT	-	19	16	9,52	3,4	-	0,8	0,9	<input type="radio"/>	<input type="radio"/>	<input type="radio"/>	YI16	NVR...-16	166	
	16IR14BSPT	-	14	16	9,52	3,4	-	1,0	1,2	<input type="radio"/>	<input type="radio"/>	<input type="radio"/>	YI16			
	16IR11BSPT	-	11	16	9,52	3,4	-	1,1	1,5	<input type="radio"/>	<input type="radio"/>	<input type="radio"/>	YI16			
Links Left hand 	11IL14BSPT	-	14	11	6,35	3,0	-	0,9	1,0	<input type="radio"/>	<input type="radio"/>	<input type="radio"/>	-	NVR...-11	166	
	16IL14BSPT	-	19	16	9,52	3,4	-	0,8	0,9	<input type="radio"/>	<input type="radio"/>	<input type="radio"/>	YE16	AVR...-16	166	
	16IL11BSPT	-	28	16	9,52	3,4	-	0,6	0,6	<input type="radio"/>	<input type="radio"/>	<input type="radio"/>	YE16	NVR...-16	166	

Bestellbeispiel Order example: 10 Stück pieces 16ER28BSPT LCP20T

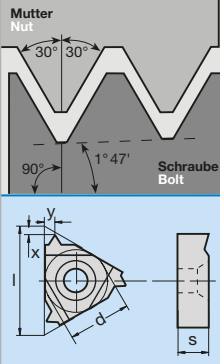
● Verfügbar ab Lager
Available from stock

○ Auf Anfrage
Upon request

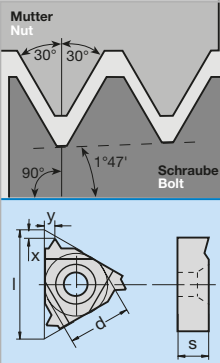

		Steigung Pitch								Sorte Grade			Unterlage Anvil	Passendes Werkzeug Suitable tool holder	Seite Page	
		mm	Gang / Zoll tpi							LCP20T	LCM25T	LWN20T				
NPT - Vollprofil NPT - Full Profile																
Rechts Right hand 	Bestellbezeichnung Ordering Code															
	16ER27NPT	-	27	16	9,52	3,4	-	0,7	0,8	○	○	○	YE16	AL..-16	166	
	16ER18NPT	-	18	16	9,52	3,4	-	0,8	1,0	○	○	○	YE16			
	16ER14NPT	-	14	16	9,52	3,4	-	0,9	1,2	○	○	○	YE16			
	16ER11,5NPT	-	11,5	16	9,52	3,4	-	1,1	1,5	○	○	○	YE16			
	16ER8NPT	-	8	16	9,52	3,4	-	1,3	1,8	○	○	○	YE16			
Links Left hand 	Bestellbezeichnung Ordering Code															
	16EL27NPT	-	27	16	9,52	3,4	-	0,7	0,8	○	○	○	YI16	AL..-16	166	
	16EL18NPT	-	18	16	9,52	3,4	-	0,8	1,0	○	○	○	YI16			
	16EL14NPT	-	14	16	9,52	3,4	-	0,9	1,2	○	○	○	YI16			
	16EL11,5NPT	-	11,5	16	9,52	3,4	-	1,1	1,5	○	○	○	YI16			
	16EL8NPT	-	8	16	9,52	3,4	-	1,3	1,8	○	○	○	YI16			



		Steigung Pitch								Sorte Grade			Unterlage Anvil	Passendes Werkzeug Suitable tool holder	Seite Page
		mm	Gang / Zoll tpi							LCP20T	LCM25T	LWN20T			
NPTF - Vollprofil NPTF - Full Profile															
Rechts Right hand 	Bestellbezeichnung Ordering Code														
	16ER27NPTF	-	8	16	9,52	3,4	-	1,3	1,8	○	○	○	YE16	AL..-16	166
	16ER18NPTF	-	11,5	16	9,52	3,4	-	1,1	1,5	○	○	○	YE16		
	16ER14NPTF	-	14	16	9,52	3,4	-	0,9	1,2	○	○	○	YE16		
	16ER11,5NPTF	-	18	16	9,52	3,4	-	0,8	1,0	○	○	○	YE16		
	16ER8NPTF	-	27	16	9,52	3,4	-	0,7	0,8	○	○	○	YE16		
Links Left hand 	Bestellbezeichnung Ordering Code														
	16EL18NPTF		-	11,5	16	9,52	3,4	-	1,1	1,5	○	○	○	YI16	AL..-16

Bestellbeispiel Order example: 10 Stück pieces 16ER27NPT LCP20T

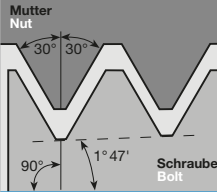
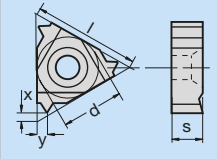
● Verfügbar ab Lager
Available from stock

○ Auf Anfrage
Upon request

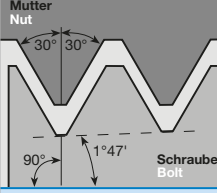
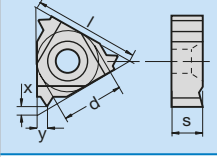
		Steigung Pitch		l	d	s	r	x	y	Sorte Grade			Unterlage Anvil	Passendes Werkzeug Suitable tool holder	Seite Page
		mm	Gang / Zoll tpi							LCP20T	LCM25T	LWN20T			
		Bestellbezeichnung Ordering Code													
Rechts Right hand 	11IR27NPT	-	14	11	6,35	3,0	-	0,8	1,0	<input type="radio"/>	<input type="radio"/>	<input type="radio"/>	-	NVR...-11	166
	11IR18NPT	-	18	11	6,35	3,0	-	0,8	1,0	<input type="radio"/>	<input type="radio"/>	<input type="radio"/>	-		
	11IR14NPT	-	27	11	6,35	3,0	-	0,7	0,8	<input type="radio"/>	<input type="radio"/>	<input type="radio"/>	-		
	16IR27NPT	-	8	16	9,52	3,4	-	1,3	1,8	<input type="radio"/>	<input type="radio"/>	<input type="radio"/>	YI16	AVR...-16	166
	16IR18NPT	-	11,5	16	9,52	3,4	-	1,1	1,5	<input type="radio"/>	<input type="radio"/>	<input type="radio"/>	YI16	NVR...-16	166
	16IR14NPT	-	14	16	9,52	3,4	-	0,9	1,2	<input type="radio"/>	<input type="radio"/>	<input type="radio"/>	YI16		
	16IR11,5NPT	-	18	16	9,52	3,4	-	0,8	1,0	<input type="radio"/>	<input type="radio"/>	<input type="radio"/>	YI16		
Links Left hand 	11IL27NPT	-	27	11	6,35	3,0	-	0,7	0,8	<input type="radio"/>	<input type="radio"/>	<input type="radio"/>	-	NVR...-11	166
	11IL18NPT	-	18	11	6,35	3,0	-	0,8	1,0	<input type="radio"/>	<input type="radio"/>	<input type="radio"/>	-		
	11IL14NPT	-	14	11	6,35	3,0	-	0,8	1,0	<input type="radio"/>	<input type="radio"/>	<input type="radio"/>	-		
	16IL14NPT	-	14	16	9,52	3,4	-	0,9	1,2	<input type="radio"/>	<input type="radio"/>	<input type="radio"/>	YE16	AVR...-16	166
	16IL11,5NPT	-	11,5	16	9,52	3,4	-	1,1	1,5	<input type="radio"/>	<input type="radio"/>	<input type="radio"/>	YE16	NVR...-16	166
	16IL8NPT	-	8	16	9,52	3,4	-	1,3	1,8	<input type="radio"/>	<input type="radio"/>	<input type="radio"/>	YE16		

		Steigung Pitch		l	d	s	r	x	y	Sorte Grade			Unterlage Anvil	Passendes Werkzeug Suitable tool holder	Seite Page
		mm	Gang / Zoll tpi							LCP20T	LCM25T	LWN20T			
		Bestellbezeichnung Ordering Code													
Rechts Right hand 	11IR18NPTF	-	18	11	6,35	3,0	-	0,8	1,0	<input type="radio"/>	<input type="radio"/>	<input type="radio"/>	-	NVR...-11	156
	11IR14NPTF	-	14	11	6,35	3,0	-	0,8	1,0	<input type="radio"/>	<input type="radio"/>	<input type="radio"/>	-		
	16IR18NPTF	-	27	16	9,52	3,4	-	0,7	0,8	<input type="radio"/>	<input type="radio"/>	<input type="radio"/>	YI16	AVR...-16	166
	16IR14NPTF	-	18	16	9,52	3,4	-	0,8	1,0	<input type="radio"/>	<input type="radio"/>	<input type="radio"/>	YI16	NVR...-16	166
	16IR11,5NPTF	-	14	16	9,52	3,4	-	0,9	1,2	<input type="radio"/>	<input type="radio"/>	<input type="radio"/>	YI16		
	16IR8NPTF	-	11,5	16	9,52	3,4	-	1,1	1,5	<input type="radio"/>	<input type="radio"/>	<input type="radio"/>	YI16		

Bestellbeispiel Order example: 10 Stück pieces 11IR27NPT LCP20T

● Verfügbar ab Lager
Available from stock

○ Auf Anfrage
Upon request

Wendeschneidplatten - Außengewinde
Indexable inserts - external threads



		Trapez DIN 103 - Vollprofil Trapezoidal DIN 103 - Full Profile										Sorte Grade			Unterlage Anvil	Passendes Werkzeug Suitable tool holder	Seite Page
		Steigung Pitch		l	d	s	r	x	y	LCP20T	LCM25T	LWN20T					
	Bestellbezeichnung Ordering Code	mm	Gang / Zoll tpi														
	Rechts Right hand 	11ER1,5TR	1,5	-	11	6,35	3,0	-	0,8	0,9	●	●	○		NL...-11	166	
16ER1,5TR		1,5	-	16	9,52	3,4	-	1,0	1,1	●	●	○	YE16	AL...-16	166		
16ER2,0TR		2,0	-	16	9,52	3,4	-	1,1	1,3	●	●	○	YE16				
16ER3,0TR		3,0	-	16	9,52	3,4	-	1,3	1,5	●	●	○	YE16				
22ER4,0TR		4,0	-	22	12,70	4,6	-	1,7	1,9	●	●	○	YE22	AL...-22	166		
22ER5,0TR		5,0	-	22	12,70	4,6	-	2,1	2,5	●	●	○	YE22				
27ER6,0TR		6,0	-	27	15,88	6,2	-	2,3	2,7	●	●	○	YE27	AL...-27			
Links Left hand 	16EL1,5TR	1,5	-	16	9,52	3,4	-	1,0	1,1	●	○	○	YI16	AL...-16	166		
	16EL2,0TR	2,0	-	16	9,52	3,4	-	1,1	1,3	●	○	○	YI16				
	16EL3,0TR	3,0	-	16	9,52	3,4	-	1,3	1,5	●	○	○	YI16				
	22EL4,0TR	4,0	-	22	12,70	4,6	-	1,7	1,9	●	○	○	YI22	AL...-22	166		
	22EL5,0TR	5,0	-	22	12,70	4,6	-	2,1	2,5	●	○	○	YI22				
	22EL6,0TR	6,0	-	22	12,70	4,6	-	2,3	2,7	●	○	○	YI22				
	27EL6,0TR	6,0	-	27	15,88	6,2	-	2,3	2,7	●	○	○	YI27	AL...-27	166		



Wendeschneidplatten - Innengewinde
Indexable inserts - internal threads



		Trapez DIN 103 - Vollprofil Trapezoidal DIN 103 - Full Profile										Sorte Grade			Unterlage Anvil	Passendes Werkzeug Suitable tool holder	Seite Page
		Steigung Pitch		l	d	s	r	x	y	LCP20T	LCM25T	LWN20T					
	Bestellbezeichnung Ordering Code	mm	Gang / Zoll tpi														
	Rechts Right hand 	11IR1,5TR	1,5	-	11	6,35	3,0	-	0,8	0,9	●	○	○	-	NVR...-11	166	
16IR1,5TR		1,5	-	16	9,52	3,4	-	1,0	1,1	●	○	○	YI16	AVR...-16	166		
16IR2,0TR		2,0	-	16	9,52	3,4	-	1,1	1,3	●	○	○	YI16	NVR...-16	166		
16IR3,0TR		3,0	-	16	9,52	3,4	-	1,3	1,5	●	○	○	YI16				
22IR4,0TR		4,0	-	22	12,70	4,6	-	1,7	1,9	●	○	○	YI22	AVR...-22	166		
22IR5,0TR		5,0	-	22	12,70	4,6	-	2,1	2,5	●	○	○	YI22	NVR...-22	166		
Links Left hand 	11IL1,5TR	1,5	-	11	6,35	3,0	-	0,8	0,9	●	○	○	-	NVR...-11	166		
	16IL1,5TR	1,5	-	16	9,52	3,4	-	1,0	1,1	●	○	○	YE16	AVR...-16	166		
	16IL2,0TR	2,0	-	16	9,52	3,4	-	1,1	1,3	●	○	○	YE16	NVR...-16	166		
	16IL3,0TR	3,0	-	16	9,52	3,4	-	1,3	1,5	●	○	○	YE16				
	22IL4,0TR	4,0	-	22	12,70	4,6	-	1,7	1,9	●	○	○	YE22	AVR...-22	166		
	22IL5,0TR	5,0	-	22	12,70	4,6	-	2,1	2,5	●	○	○	YE22	NVR...-22	166		

Bestellbeispiel Order example: 10 Stück pieces 11ER1,5TR LCP20T

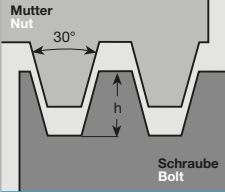
● Verfügbar ab Lager
Available from stock

○ Auf Anfrage
Upon request

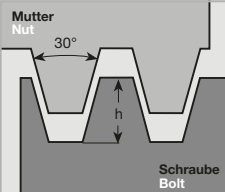
		Trapez DIN 103 - Vollprofil Trapezoidal DIN 103 - Full Profile Form V, Form V										Sorte Grade LCP20T LCM25T LWN20T			Unterlage Anvil	Passendes Werkzeug Suitable tool holder	Seite Page						
		Steigung Pitch		l	d	s	r	x	y	mm	Gang / Zoll tpi												
Bestellbezeichnung Ordering Code		mm	Gang / Zoll tpi									l	d	s	r	x	y	mm	Gang / Zoll tpi	l	d	s	r
Rechts Right hand 	27VER6,0TR	6,0	-	27	15,88	6,0	-	1,0	3,3	●	●										NL...-27....V	167	
	27VER7,0TR	7,0	-	27	15,88	6,0	-	1,0	3,3	●	●												
	27VER8,0TR	8,0	-	27	15,88	6,0	-	1,0	3,3	●	●												
	27VER12,0TR	12,0	-	27	15,88	10,0	-	1,0	5,2	●	●												
Links Left hand 	27VEL6,0TR	6,0	-	27	15,88	6,0	-	1,0	3,3	●	●											NL...-27....V	167
	27VEL7,0TR	7,0	-	27	15,88	6,0	-	1,0	3,3	●	●												
	27VEL8,0TR	8,0	-	27	15,88	6,0	-	1,1	3,3	●	●												
	27VEL10,0TR	10,0	-	27	15,88	8,0	-	1,7	4,3	●	●												

		Trapez DIN 103 - Vollprofil Trapezoidal DIN 103 - Full Profile Form U, Form U										Sorte Grade LCP20T LCM25T LWN20T			Unterlage Anvil	Passendes Werkzeug Suitable tool holder	Seite Page						
		Steigung Pitch		l	d	s	r	x	y	mm	Gang / Zoll tpi												
Bestellbezeichnung Ordering Code		mm	Gang / Zoll tpi									l	d	s	r	x	y	mm	Gang / Zoll tpi	l	d	s	r
U-TYP U-Typ 	Rechts / right																						
	22UE6,0TR	6,0	-	22	12,70	6,0	-	1,0	11,0	●	●										YE22U	AL...-22....U	167
	22UE7,0TR	7,0	-	22	12,70	6,0	-	1,0	11,0	●	●										YE22U		
	22UE8,0TR	8,0	-	22	12,70	6,0	-	1,0	11,0	●	●										YE22U		
	27UE8,0TR	8,0	-	27	15,88	8,0	-	1,0	13,7	●	●										YE27U	AL...-27....U	167
rechts und links verwendbar usable for right and left side	Links / left																						
	22UE6,0TR	6,0	-	22	12,70	6,0	-	1,0	11,0	●	●										YI22U	AL...-22....U	167
	22UE7,0TR	7,0	-	22	12,70	6,0	-	1,0	11,0	●	●										YI22U		
	22UE8,0TR	8,0	-	22	12,70	6,0	-	1,0	11,0	●	●										YI22U		
	27UE8,0TR	8,0	-	27	15,88	8,0	-	1,0	13,7	●	●										YI27U	AL...-27....U	167
27UE9,0TR	9,0	-	27	15,88	8,0	-	1,0	13,7	●	●										YI27U			

Bestellbeispiel Order example: 10 Stück pieces 27VER6,0TR LCM25T

● Verfügbar ab Lager
Available from stock

○ Auf Anfrage
Upon request



Klemhalter, Außenbearbeitung Tool holder, external machining

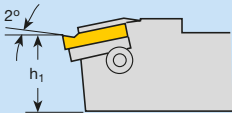
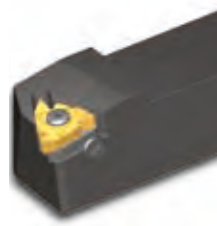
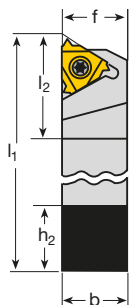

		Bestellbezeichnung Ordering Code	$b = h_2 = h_1$	f	l_1	l_2	Plattengröße Insert size
		NL12-11	12	12	80	17,5	11
		AL16-16	16	16	100	22	16
		AL20-16	20	20	128,6	30	16
		AL25-16	25	25	153,6	30	16
		AL32-16	32	32	173,6	30	16
		AL25-22	25	25	155,7	36	22
		AL32-22	32	32	175,7	36	22
		AL32-27	32	32	175,9	40	27
		AL40-27	40	40	205,9	40	27

Bestellbeispiel Order example: 1 Stück piece NL12-11

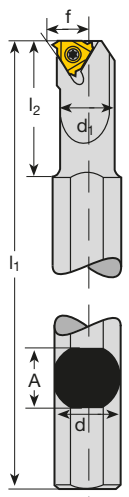
Klemhalter, Innenbearbeitung Tool holder, internal machining

		Bestellbezeichnung Ordering Code	A	l_1	l_2	d	d_1	f	D_{min}	Plattengröße Insert size
	<p>Halter mit Kühlmittelbohrung Tool holder with coolant</p>	NVRC10-11	18,0	180	25	20	10,0	7,3	13	11
		NVRC13-11	18,0	180	32	20	13,0	8,9	16	11
		NVRC13-16	18,0	180	32	20	12,7	10,3	17	16
		NVRC16-16	18,0	180	40	20	16,0	11,5	20	16
		NVRC16D-16	15,2	150	32	16	16,0	11,3	20	16
		AVRC20-16	18,0	180	40	20	20,0	13,4	24	16
		AVRC25-16	29,0	250	60	32	25,0	16,3	29	16
		AVRC25D-16	22,6	200	45	25	24,6	16,1	29	16
		AVRC32-16	29,0	250	60	32	32,0	19,6	36	16
		AVRC40-16	36,0	300	60	40	40,0	23,8	44	16
		NVRC20-22	18,0	180	50	20	20,0	15,6	27	22
		AVRC25-22	29,0	250	60	32	25,0	17,4	32	22
		AVRC32-22	29,0	250	60	32	32,0	21,5	39	22
		AVRC40-22	36,0	300	60	40	40,0	25,8	47	22
		AVRC50-27	45	350	75	50	50,0	31,4	58	27
AVRC60-27	54	400	75	60	60,0	36,4	69	27		

Bestellbeispiel Order example: 1 Stück piece NVRC10-11

Die Halter der Tabellen sind Rechtsausführung.

Für Linksausführung bitte -LH an die Bezeichnung anfügen.

Alle Halter haben einen 1,5° Steigungswinkel. Andere Steigungswinkel für AL.. und AVRC..-Halter durch

Wechsel der Unterlegplatte (siehe Seite 168). NVRC-Halter haben keine Unterlagsplatte.

Anmerkung: Außen- und Innenhalter auch mit Spannfinger "Typ C" auf Anfrage erhältlich (z.B.: NVRC16-16C)

The above holders are right hand execution.



To obtain left hand execution, please add LH to the ordering code.

All holders have a 1,5° helix angle. Using AL.. and AVRC..-holders helix angle can be varied by changing the anvil (please refer to page 168). NVRC holders are without anvil.

Notice: external and internal holder also with clamping finger "type C", available on demand (e.g.: NVRC16-16C)

Klemmhalter, Außenbearbeitung
Tool holder, external machining

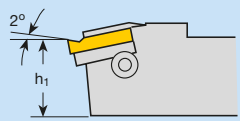

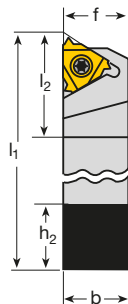

		Bestellbezeichnung Ordering Code	$b = h_2 = h_1$	f	l_1	l_2	Plattengröße Insert size
 		NL32-27V-6	32	32	170	40	27
		NL32-27V-8	32	34,1	170	40	27
		NL32-27V-10	32	35,8	170	40	27
		NL40-27V-6	40	40,0	200	40	27
		NL40-27V-8	40	42,1	200	40	27
		NL40-27V-10	40	43,8	200	40	27

Bestellbeispiel Order example: 1 Stück piece NL32-27V-6

Wendeschneidplatte siehe Seite 165 Form V
 Insert see page 165 Form V

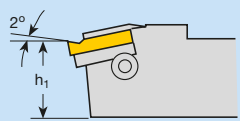
Klemmhalter, Außenbearbeitung
Tool holder, external machining

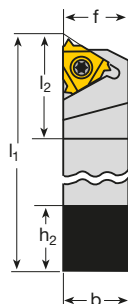
		Bestellbezeichnung Ordering Code	$b = h_2 = h_1$	f	l_1	l_2	Plattengröße Insert size
 		AL25-22U	25	25	178,4	38	22
		AL32-22U	32	32	178,4	38	22
		AL40-22U	40	40	208,4	38	22
		AL25-27U	25	25	179,1	40	27
		AL32-27U	32	32	179,1	40	27
		AL40-27U	40	40	209,1	40	27
		AL50-27U	50	50	259,1	40	27

Bestellbeispiel Order example: 1 Stück piece AL25-22U

Wendeschneidplatte siehe Seite 165 Form U
 Insert see page 165 Form U

Klemmhalter Tool holder	Plattengröße Insert size	Klemmschraube Clamp screw	Schraube + Scheibe Screw + Washer	Schlüssel Key	Unterlagsplatte Anvil	
Bestellbezeichnung Ordering Code					RH/in LH	LH/ in RH
NVRC	11	SN11T	-	V02-T-0800	-	-
NVRC	16	SN16T	-	V02-T-1000	-	-
NVRC	22	SN22T	-	V02-T-2000	-	-
"Standard"	16	SA16T	SY16T	V02-T-1000	YE16	YI16
"Standard"	22	SA22T	SY22T	V02-T-2000	YE22	YI22
(AL..., AV...)	27	SA27T	SY27T	V02-T-2500	YE27	YI27
Standard mit Klemmfinger	16	SA16T/C3	SY16T	V02-T-1000	YE16	YI16
Standard with clamping finger	22	SA22T/C4	SY22T	V02-T-2000	YE22	YI22
	27	SA27T/C5	SY27T	V02-T-2500	YE27	YI27
U - Type	22	SA22T	SY22T	V02-T-2000	YE22U	YI22U
	27	SA27T	SY27T	V02-T-2500	YE27U	YI27U
V - Type	27V	SN27T	-	V02-T-3000	-	-

Unterlagsplatten-Sortiment
Anvil sets

Wir empfehlen Ihnen diese Sortimente, damit Sie jederzeit für alle Bearbeitungsfälle gerüstet sind.
 We recommend you to buy these kits in order to have on hand the right anvil for any job at any time.

Unterlagsplatte Anvil	Bestellnummer Ordering code	Das Sortiment beinhaltet je 1 Stück The set includes 1 of each
16	ABY16	YE16-2P, 1P, 1N, 2N, 3N, YI16-2P, 1P, 1N, 2N, 3N
22	ABY22	YE22-2P, 1P, 1N, 2N, 3N, YI22-2P, 1P, 1N, 2N, 3N
27	ABY27	YE27-2P, 1P, 1N, 2N, 3N, YI27-2P, 1P, 1N, 2N, 3N
22U	ABY22U	YE22U-2P, 1P, 1N, 2N, 3N, YI22-2P, 1P, 1N, 2N, 3N
27U	ABY27U	YE27U-2P, 1P, 1N, 2N, 3N, YI22-2P, 1P, 1N, 2N, 3N

Bestellbeispiele Ordering example: 1 Stück AL25-16 (... rechte Ausführung) 1 piece AL25-16 (...right hand execution)
 1 Stück AL25-16LH (... linke Ausführung) 1 piece AL25-16LH (... left hand execution)

Sorte Grade	ISO	Anwendungsbereich Range of applications	Werkstoffgruppe Group of materials						Bearbeitungsverfahren Processing method					
			P Stahl Steel	M Rostfrei Stainless	K Grauguss Grey cast iron	N NE-Metalle (Al etc.) Nonferrous metals	S Hochwarmfest High temper- ature materials	H Harte Werkstoffe Hard mate- rials	T Drehen Turning	M Fräsen Milling	D Bohren Drilling	S Gewinde- bearbeitung Threading	G Einstechen Grooving	P Abstechen Parting
LCP20T	HC-P20		■	□							●			
LCM25T	HC-M20		□	■							●			
	HC-K20				■						●			
LWN20T	HC-N20					■	□				●			
Anwendungsschwerpunkt Application peak			■ Hauptanwendung Main application □ Weitere Anwendung Further applications						● Standardsorte Standard grade					
Gesamtbereich nach ISO 513 Full range to ISO 513														

Hauptsorten beschichtet

● LCP20T (HC-P20)

Hauptsorte für die Stahlbearbeitung. Hohe Bruchfestigkeit auch bei ungünstigen Bedingungen.
Feinstkornsubstrat mit dünner TiAlN-Beschichtung.

● LCM25T (HC-M20, HC-K20)

Hauptsorte für die Rostfreibearbeitung.
Äußerst gut geeignet für die Bearbeitung von säurebeständigen Materialien.

● LWN20T (HC-N20)

Unbeschichtete K20 Feinkornsorte für die Bearbeitung von NE-Metallen, Aluminium, Titan und hitzebeständige Legierungen.

Main grade coated

● LCP20T (HC-P20)

Main grade for steel machining. High breaking strength also on bad conditions.
Micro grain substrate with thin TiAlN coating.

● LCM25T (HC-M20, HC-K20)

Main grade for stainless machining.
Extremely good applicable for the machining of acid proofed materials.

● LWN20T (HC-N20)

Uncoated K20 fine grain grade for the machining of non ferrous metals, aluminium, titanium and heat resistant alloys.

Außen Rechtsgewinde
External thread right hand

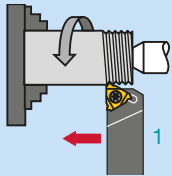

Platte und Halter rechts,
b: Standard
Insert and holder right hand,
b: regular

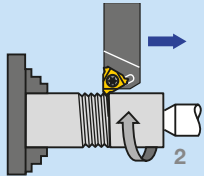

Platte und Halter links,
b: Umgekehrt
Insert and holder left hand,
b: reverse

Außen Linksgewinde
External thread left hand

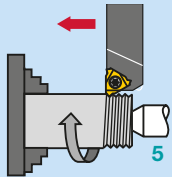

Platte und Halter links,
b: Standard
Insert and holder left hand,
b: regular

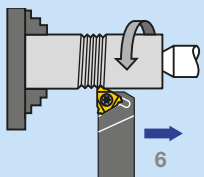

Platte und Halter rechts,
b: Umgekehrt
Insert and holder right hand,
b: reverse

Innen Rechtsgewinde
Internal thread right hand

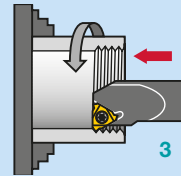

Platte und Halter rechts,
b: Standard
Insert and holder right hand,
b: regular

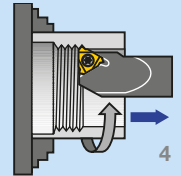

Platte und Halter links,
b: Umgekehrt
Insert and holder left hand,
b: reverse

Innen Linksgewinde
Internal thread left hand

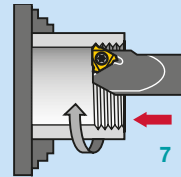

Platte und Halter links,
b: Standard
Insert and holder left hand,
b: regular

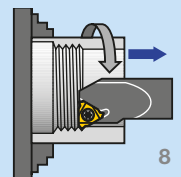

Platte und Halter rechts,
b: Umgekehrt
Insert and holder right hand,
b: reverse

Flankenfreiwinkel α Flank clearance angle α :

Im Klemmhalter festgeschraubte Platten sind zur Erzeugung des Freiwinkels nach vorne geneigt, (10° Neigung bei Außen-Klemmhaltern, 15° Neigung bei Innen-Klemmhaltern). Da der Freiwinkel α je Flankenwinkel Φ variiert, geben wir Ihnen nebenstehend eine Formel zur Berechnung von α und auf Seite 170 einige technische Beispiele, woraus hervor geht, dass die Einstellung des korrekten Steigungswinkels (mittels Unterlegplatten) sehr wichtig ist, vor allem bei Gewinden mit kleinen Flankenwinkeln, damit die Platte auf keine der beiden Seiten drückt.

The tool holders are designed to tilt the insert when seated in the holder, (10° for external, 15° for internal tooling).

As the flank clearance angle α varies depending on the enclosed flank angle Φ , we give here a formula to calculate α and on page 170 some examples which show the importance of a correct adjustment of the helix angle by the help of anvils, especially in profiles with small enclosed flank angles to avoid rubbing of the insert cutting edge on the workpiece.

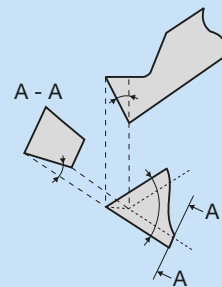
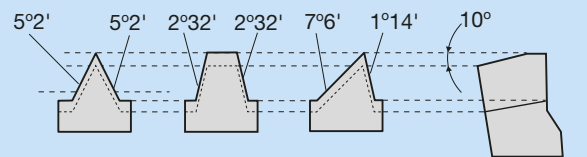

$$\alpha = \arctan(\sin \delta / 2 \times \tan \delta)$$

wobei: α = Flankenfreiwinkel
where: Flank clearance angle
 δ = Neigungswinkel
Tilt angle
 Φ = Flankenwinkel
Enclosed flank angle

Radial
Radial infeed

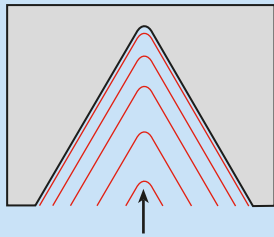

Entlang der Flanke
Flank infeed

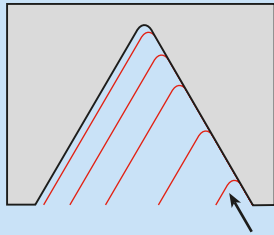

Wechselseitige
Zustellung
Alternating flank
infeed method

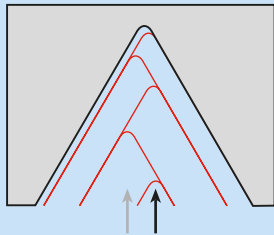

Wahl der richtigen
Unterlagsplatten
Choosing the
correct anvil

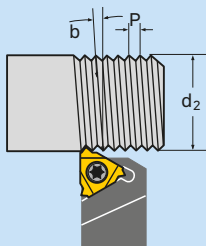

Der Steigungswinkel¹⁾

Formel zur Berechnung:

$$\beta = \arctan \frac{P}{\pi \times d_2} \quad (\text{vereinfacht: } \beta = \frac{P}{d_2} \times 20)$$

wobei: β = Steigungswinkel [°]
P = Gewindesteigung [mm]
 d_2 = Flankendurchmesser [mm]

The Helix Angle¹⁾

Formula for it's calculation:

$$\beta = \arctan \frac{P}{\pi \times d_2} \quad (\text{simplified: } \beta = \frac{P}{d_2} \times 20)$$

where: β = Helix angle [°]
P = pitch [mm] (use lead for multi-start threads)
 d_2 = pitch diameter [mm]

Radial

Die radiale Zustellung ist die einfachste und gängigste Methode. Zustellung senkrecht zur Drehachse.

Spanabhebende Bearbeitung auf beiden Flanken des Profils.

Die radiale Zustellung wird empfohlen:

- bei Steigung kleiner als 1,0 mm
- bei kurzspanenden Werkstoffen
- bei Werkstoffen, die zur Kaltverfestigung neigen

Radial infeed

Radial infeed is the simplest and most popular method.

The feed is perpendicular to the turning axis, and both flanks on the insert perform the cutting operation.

Radial infeed is recommended:

- when the pitch is smaller than 1.0 mm
- for materials with short chips
- for materials having cold hardening tendency

Entlang der Flanke

ist zu empfehlen:

- bei Steigung größer als 1,0 mm. Bei radialer Zustellung wäre die Schneidkante zu lang, was zum Rattern führen würde.
- Bei TRAPEZ und ACME-Gewinde, weil das Spannen an drei Schneidkanten für den Spanfluß von Nachteil ist.

Flank infeed

is recommended:

- when the thread pitch is more than 1.0 mm. Using the radial method, the effective cutting edge length is too large, resulting in chatter
- for TRAPEZOIDAL and ACME thread. The radial method result in three cutting edges, making chip flow very difficult

Wechselseitige Zustellung

Besonders empfohlen bei sehr großen Steigungen, bzw. bei langspanenden Werkstoffen. Von Vorteil ist Aufteilung der Bearbeitungen entlang beider Flanken und der gleichmäßige Verschleiß auf beiden Schneidkanten. Wegen der aufwendigen Programmierung ist diese Zustellmethode nicht auf allen Maschinen möglich.

Alternating flank infeed method

Use of the alternate flank infeed method is recommended especially in large pitches, and for materials with long chips. This method divides the work equally on both flanks, resulting in equal wear along the cutting edges. Alternate flank infeed requires more complicated programming and is not available on all lathes.

¹⁾ Der Steigungswinkel kann auch mit Hilfe des Diagramms auf Seite 172 ermittelt werden.

¹⁾ The helix angle can also be found from the graph on page 172.

Die Auswahl der richtigen Unterlagsplatte erfolgt entsprechend Tabelle auf Seite 172.

To determine the correct anvil use the table on page 172.

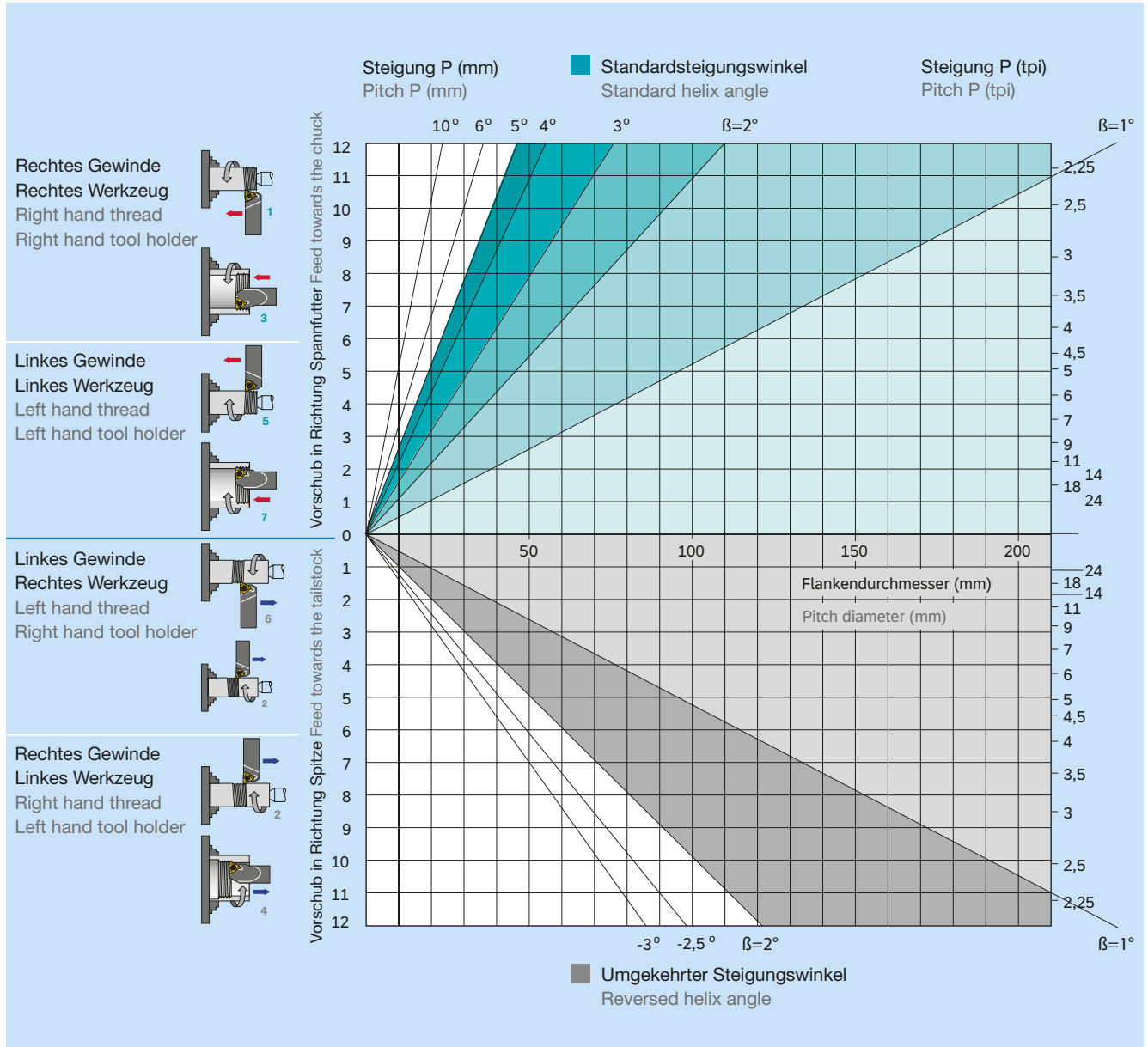

Unterlagsplatten
Anvils

Steigungswinkel Helix angle		4,5	3,5	2,5	1,5	0,5	0	-0,5	-1,5
Platte I = Insert I =	Halter Holder	Bestellbezeichnung Ordering Code							
16	ER/IL	YE16-3P	YE16-2P	YE16-1P	YE16	YE16-1N	YE16-1,5N	YE16-2N	YE16-3N
16	EL/IR	YI16-3P	YI16-2P	YI16-1P	YI16	YI16-1N	YI16-1,5N	YI16-2N	YI16-3N
22	ER/IL	YE22-3P	YE22-2P	YE22-1P	YE22	YE22-1N	YE22-1,5N	YE22-2N	YE22-3N
22	EL/IR	YI22-3P	YI22-2P	YI22-1P	YI22	YI22-1N	YI22-1,5N	YI22-2N	YI22-3N

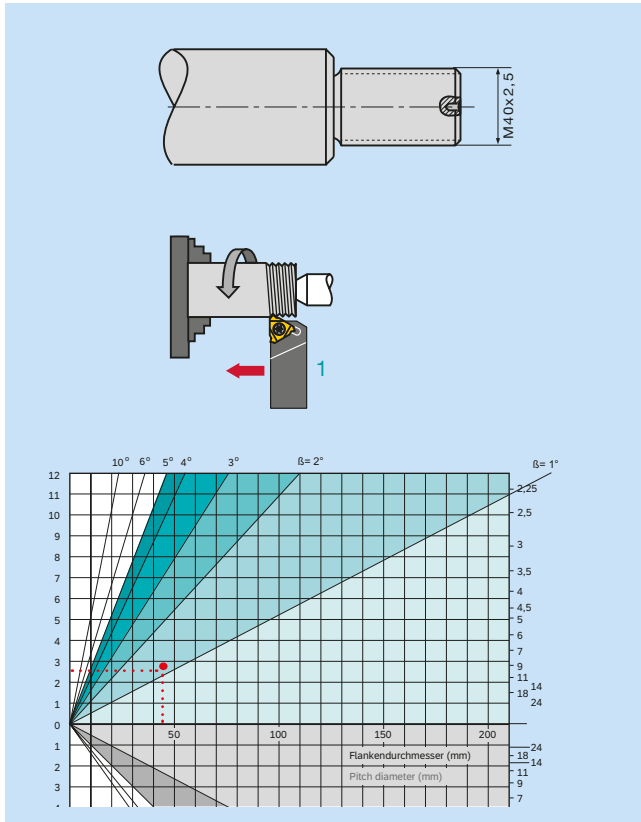

Gewinde: ISO-metrisches Gewinde, M40 x 2,5 außen rechts
Werkstoff: 42CrMo4
Gewählte Arbeitsmethode: Nr. 1, Vorschub zum Spannfutter
Klemmhalter: AL25-16
Wendplatte: 16ER2,5ISO
Boehlerit Sorte: LCP20T

Ermittlung des Steigungswinkels und Wahl der Unterlagsplatte:
Aus der Graphik Seite 172 wird ein Steigungswinkel β zwischen 1° und 2° abgelesen. Aus der Tabelle auf Seite 172 wird diesem Steigungswinkel die Unterlagsplatte YE16 zugeordnet.
Schnittgeschwindigkeit und Anzahl der Durchgänge werden aus den Angaben der Tabellen auf den Seiten 174 -175 entnommen:
 v_C : 120 m/min, Durchgänge: 10

Thread: ISO-metric M40 x 2,5 external right hand
Material: 42CrMo4
Chosen working method: No1, feed towards the chuck
Tool holder: AL25-16
Insert: 16ER2,5ISO
Boehlerit grade: LCP20T

Determination of the helix angle and choice of the correct anvil:
From the diagram on page 172 a helix angle β between 1° and 2° is found. To this helix angle corresponds anvil YE16 in the table on page 172. Cutting speed and number of passes are taken from the tables on pages 174 - 175:
 v_C : 120 m/min, Number of passes: 10

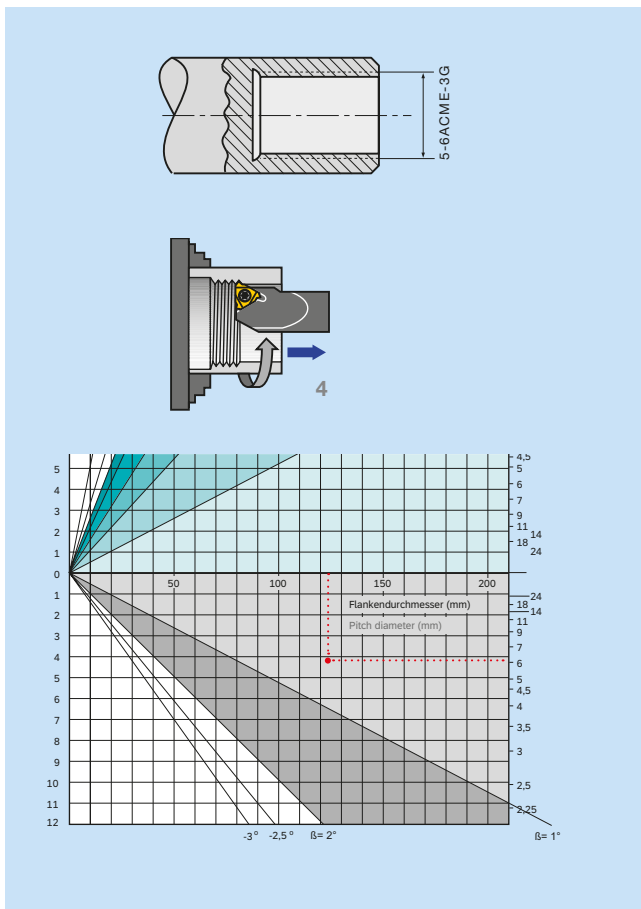

Gewinde: ACME innen rechts
Steigung: 6 tpi (Gänge pro Zoll)
Bohrungsdurchm.: 5"
Werkstoff: NIRO austenitisch
Gewählte Arbeitsmethode: Nr.4, Vorschub weg vom Spannfutter (zur besseren Spanabfuhr)
Klemmhalter: AVR40-22LH
Wendplatte: 22IL6ACME
Boehlerit Sorte: LCM25T

Ermittlung des Steigungswinkels und Wahl der Unterlagsplatte:
Aus der Graphik Seite 172 wird ein Steigungswinkel β zwischen 0° und 1° abgelesen. Aus der Tabelle auf Seite 172 wird diesem Steigungswinkel die Unterlagsplatte YE22-2N zugeordnet.
Schnittgeschwindigkeit und Anzahl der Durchgänge werden aus den Angaben der Tabellen auf den Seiten 174 - 175 entnommen:
 v_C : 150 m/min, Durchgänge: 18

Thread: ACME internal right hand
Pitch: 6 tpi
Diameter of hole: 5"
Material: Stainless austenitic
Chosen working method: No.4, feed off the chuck (for better evacuation of the chips)
Tool holder: AVR40-22LH
Insert: 22IL6ACME
Boehlerit grade: LCM25T

Determination of the helix angle and choice of the correct anvil:
From the diagram on page 172 a helix angle β between 0° and 1° is found. To this helix angle corresponds anvil YE22-2N in the table on page 172. Cutting speed and number of passes are taken from the tables on pages 174 - 175:
 v_C : 150 m/min, Number of passes: 18

	Problem							
	Extremer Freiflächenverschleiß Increased insert flank wear	Ungleichmäßiger Schneidkantenverschleiß Uneven cutting edge wear	Extreme plastische Verformung Extreme plastic deformation	Plattenbruch Cutting edge breakage	Aufbauschneidenbildung Built-up edge	Zu flaches Gewindeprofil Thread profile is too shallow	Schlechte Oberflächengüte Poor surface quality	
Abhilfe								
Option								
HM-Verschleißfestigkeit Carbide wear resistance	↑		↑		↑			
HM-Zähigkeit Carbide toughness				↑				
Schnittgeschwindigkeit Cutting speed	↓		↓		↑		↓	
Vorschub Feed			↓	↓				
Zahl der Durchgänge Number of passes			↑	↑				
Flankenzustellung Flank infeed method		↔					↔	
Unterlagsplatte Anvil		↔					↔	
Schneidkantenhöhe Height of cutting edge						↔		
Spannung Fixation					↔			
Rohlingsmaß Size of the blank						↔		
Kühlung Cooling	↑		↑	↔				
Schneidplattenwechsel Change of the cutting edge						↔		
↑ erhöhen, vergrößern increase ↓ vermindern, verkleinern reduce ↔ optimieren, kontrollieren optimize								

Anzahl der Durchgänge
Number of passes

Steigung Pitch	mm	0,50	0,75	1,00	1,25	1,50	1,75	2,00	2,50	3,00	3,50	4,00	4,50	5,00	5,50	6,00	8,00
	Gänge/Zoll tpi	48	32	24	20	16	14	12	10	8	7	6	5,5	5	4,5	4	3
Anzahl Durchgänge Number of passes		4-6	4-7	4-8	5-9	6-10	7-12	7-12	8-14	9-16	10-18	11-18	11-19	12-20	12-20	12-20	15-24

Werkstoffgruppe Material group	Gliederung der Werkstoff-Hauptgruppen und Kennbuchstaben Mainworkpiece material groups and their characteristics letters		Brinell Härte Brinell hardness HB				
				LCP20T	LCM25T	LWN20T	
				v _C (m/min)	v _C (m/min)	v _C (m/min)	
Werkstoff Material							
P	Unlegierter Stahl ¹⁾ Unalloyed steel ¹⁾	ca. 0,15%C gegläht annealed	125	115 – 190			
		ca. 0,45 %C gegläht annealed	150	100 – 175			
		ca. 0,75 %C vergütet heat treated	170	90 – 165			
	Niedrig legierter Stahl ¹⁾ Low-alloy steel ¹⁾	geglüht annealed	180	100 – 180			
		vergütet heat treated	275	75 – 140			
		vergütet heat treated	350	70 – 135			
	Hochlegierter Stahl und hochlegierter Werkzeugstahl ¹⁾ High-alloy steel and high alloy tool steel ¹⁾	geglüht annealed	200	80 – 120			
		gehärtet und angelassen	325	50 – 100			
		annealed	200	80 – 120			
	Stahlguss ¹⁾ Steel cast ¹⁾	gehärtet und angelassen	325	50 – 100			
annealed		200	80 – 120				
hardened and temp.		325	50 – 100				
M	Nichtrostender Stahl ¹⁾ ferritisch Stainless steel ¹⁾ ferritic	ungehärtet	200	70 – 130	70 - 150		
		gehärtet	330	60 – 115	60 - 125		
	Nichtrostender Stahl ¹⁾ austenitisch Stainless steel ¹⁾ austenitic	unhardenable	200	70 – 130	70 - 150		
		hardened	300	60 – 115	60 - 125		
	Edelstahlguss ¹⁾ ferritisch Special steel cast ¹⁾ ferritic	austenitisch	180	90 – 140	90 - 160		
		Duplex	200	40 – 110	40 - 120		
	Edelstahlguss ¹⁾ austenitisch Special steel cast ¹⁾ austenitic	austenitic	180	90 – 140	90 - 160		
		Duplex	200	40 – 110	40 - 120		
	Edelstahlguss ¹⁾ austenitisch Special steel cast ¹⁾ austenitic	ungehärtet	200	90 – 120	90 - 150		
		gehärtet	330	65 – 110	65 - 120		
K	Grauguss Grey cast iron	perlitisch/ferritisch perlitic/ferritic	180	70 – 130			
		perlitisch (martensitisch) perlitic (martensitic)	260	60 – 115			
	Gusseisen mit Kugelgraphit Nodular graphite cast iron	ferritisch ferritic	160	125 – 160			
		perlitisch perlitic	260	90 – 120			
	Temperguss Malleable cast iron	ferritisch ferritic	130	60 – 70			
		perlitisch perlitic	230	60 – 145			
	N	Aluminium-Legierungen schmiedeeisern Aluminium alloys forge ironed	gewalzt nicht aushärtbar rolled, not hardenable	60	100 - 365		100 – 250
		Aluminium-Legierungen Aluminium alloys	gegossen, nicht aushärtbar casted, not hardenable	75	200 - 400		80 – 120
Aluminium-Legierungen Aluminium alloys		Guss Si 13-22% cast Si 13-22%	130	60 - 180		50 - 120	
Kupfer und Kupferlegierungen (Bronze/Messing) Copper and copper alloys (Bronze/Brass)	Messing	90	80 - 225		70 - 170		
	Bronze und bleifreies Kupfer	100	80 - 255		70 - 170		
	Brass						
S	Warmfeste Legierungen Heat resistant alloys	Fe-Basis vergütet heat treated	200	45 - 60		30 - 50	
		Fe-based gealtert aged	280	30 - 50		25 - 40	
		Ni- oder Co-Basis vergütet heat treated	250	20 - 30		20 - 30	
		Ni- or Co-based gealtert aged	350	15 - 25		15 - 25	
	Titanlegierungen Titanium alloys	Reintitan Pure titanium	400Rm	140 - 170		60 - 100	
		Alpha + Beta-Legierungen, ausgehärtet Alpha- and Beta-alloys hardened	1050Rm 1050Rm	50 - 70 50 - 70		40 - 60 40 - 60	
H	Gehärteter Stahl Hardened steel	gehärtet und angelassen	45-50HRC	45 - 60			
		hardened and angelassen	51-55HRC	40 - 50			
		hardened and angelassen	45-50HRC	45 - 60			
		tempered	51-55HRC	40 - 50			

¹⁾und Stahlguss
and cast steel

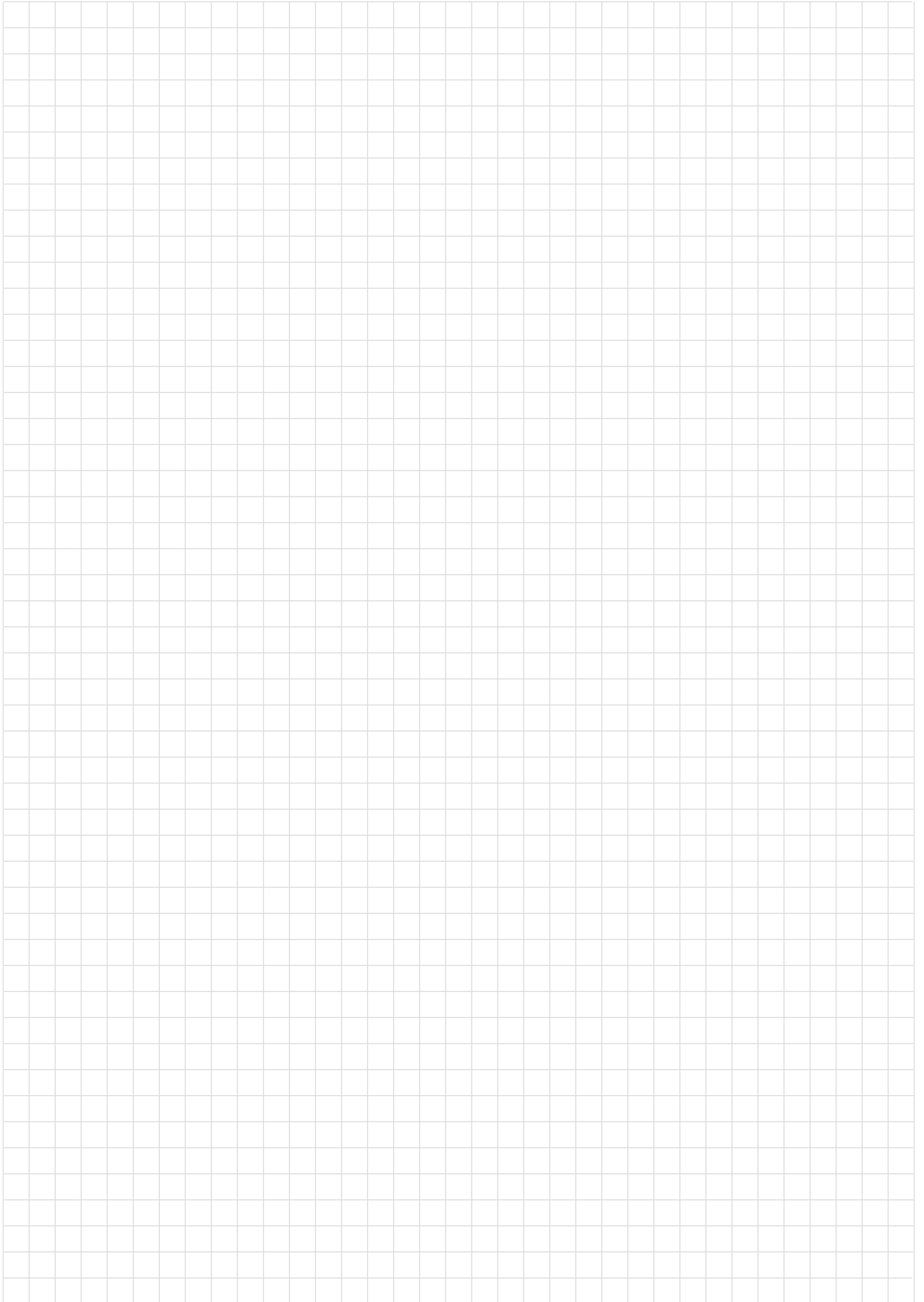

Anhang
Attachment

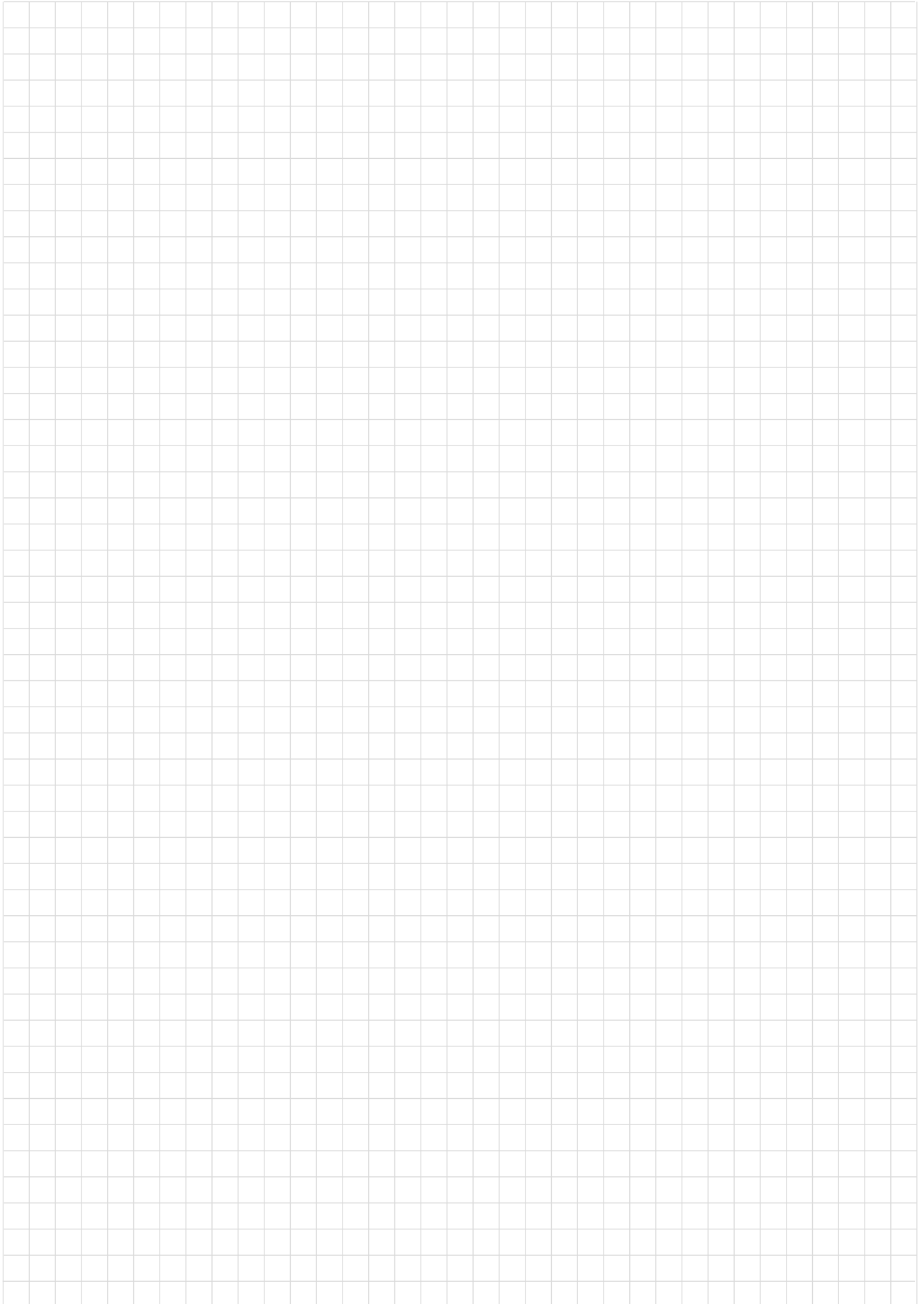

Anhang**Attachment**

Werkstückstoff-Vergleichstabelle	Comparison table of materials	180
Vergleich ISO – zu ANSI-Kennzeichnung	Comparison ISO and ANSI designation	188
Härte-Vergleichstabelle	Hardness-comparison table	191

Werkstoff-Gruppe Material group	Deutschland Germany		Großbritannien Great Britain		Frankreich France	Italien Italy
	W-Nr.	DIN	BS	EN	AFNOR	UNI
P	Baustahl und Konstruktionsstahl Constructional steels					
	1.0401	C15	080M15	-	CC12	C15C16
	1.0402	C22	050A20	2C	CC20	C20C21
	1.0501	C35	060A35	-	CC35	C35
	1.0503	C45	080M46	-	CC45	C45
	1.0535	C55	070M55	-	-	C55
	1.0601	C60	080A62	43D	CC55	C60
	1.0715	9SMn28	230M07	-	S250	CF9SMn28
	1.0718	9SMnPb28	-	-	S250Pb	CF9SMnPb28
	1.0722	10SPb20	-	-	10PbF2	CF10SPb20
	1.0726	35S20	212M36	8M	35MF4	-
	1.0736	9SMn36	240M07	1B	S300	CF9SMn36
	1.0737	9SMnPb36	-	-	S300Pb	CF9SMnPb36
	1.0904	55Si7	250A53	45	55S7	55Si8
	1.0961	60SiCr7	-	-	60SC7	60SiCr8
	1.1141	Ck15	080M15	32C	XC12	C16
	1.1157	40Mn4	150M36	15	35M5	-
	1.1158	Ck25	-	-	-	-
	1.1167	36Mn5	-	-	40M5	-
	1.1170	28Mn6	150M28	14A	20M5	C28Mn
	1.1183	Cf35	060A35	-	XC38TS	C36
	1.1191	Ck45	080M46	-	XC42	C45
	1.1203	Ck55	070M55	-	XC55	C50
	1.1213	Cf53	060A52	-	XC48TS	C53
	1.1221	Ck60	080A62	43D	XC60	C60
	1.1274	Ck101	060A96	-	-	-
	1.3401	X120Mn12	Z120M12	-	Z120M12	XG120Mn12
	1.3505	100Cr6	534A99	31	100C6	100Cr6
	1.5415	15Mo3	1501-240	-	15D3	16Mo3KW
	1.5423	16Mo5	1503-245-420	-	-	16Mo5
	1.5622	14Ni6	-	-	16N6	14Ni6
	1.5662	X8Ni9	1501-509;510	-	-	X10Ni9
	1.5680	12Ni19	-	-	Z18N5	-
	1.5710	36NiCr6	640A35	111A	35NC6	-
	1.5732	14NiCr10	-	-	14NC11	16NiCr11
	1.5752	14NiCr14	655M13; 655A12	36A	12NC15	-
	1.6511	36CrNiMo4	816M40	110	40NCD3	38NiCrMo4(KB)
	1.6523	21NiCrMo2	805M20	362	20NCD2	20NiCrMo2
	1.6546	40NiCrMo22	311-Type 7	-	-	40NiCrMo2(KB)
	1.6582	34CrNiMo6	817M40	24	35NCD6	35NiCrMo6(KB)
1.6587	17CrNiMo6	820A16	-	18NCD6	-	
1.6657	14NiCrMo134	832M13	36C	-	15NiCrMo13	
1.7015	15Cr3	523M15	-	12C3	-	
1.7033	34Cr4	530A32	18B	32C4	34Cr4(KB)	
1.7035	41Cr4	530M40	18	42C4	41Cr4	
1.7045	42Cr4	-	-	-	-	
1.7131	16MnCr5	(527M20)	-	16MC5	16MnCr5	
1.7176	55Cr3	527A60	48	55C3	-	
1.7218	25CrMo4	1717CDS110	-	25CD4	25CrMo4(KB)	
1.7220	34CrMo4	708A37	19B	35CD4	35CrMo4	
1.7223	41CrMo4	708M40	19A	42CD4TS	41CrMo4	
1.7225	42CrMo4	708M40	19A	42CD4	42CrMo4	

	Belgien Belgium	Schweden Sweden	Spanien Spain	USA U.S.A.
	NBN	SS	UNE	AISI/SAE
	-	1350	F.111	1015
	C25-1	1450	F.112	1020
	C35-1	1550	F.113	1035
	C45-1	1650	F.114	1045
	C55-1	1655	-	1055
	C60-1	-	-	1060
	-	1912	11SMn28	1213
	-	1914	11SMnPb28	12L13
	-	-	10SPb20	-
	-	1957	F210G	1140
	-	-	12SMn35	1215
	-	1926	12SMn35	12L14
	55Si7	2085	56Si7	9255
	60SiCr8	-	60SiCr8	9262
	C16-2	1370	C15K	1015
	-	-	-	1039
	C25-2	-	-	1025
	-	2120	36Mn5	1335
	28Mn6	-	-	1330
	C36	1572	-	1035
	C45-2	1672	C45K	1045
	C55-2	-	C55K	1055
	C53	1674	-	1050
	C60-2	1678	-	1060
	-	1870	-	1095
	-	-	XG120Mn12	-
	-	2258	F.131	52100
	16Mo3	2912	16Mo3	ASTM A204Gr.A
	16Mo5	-	16Mo5	4520
	18Ni6	-	15Ni6	ASTM A350LF5
	10Ni36	-	XBNI09	ASTM A353
	12Ni20	-	-	2515
	-	-	-	3135
	-	-	15NiCr11	3415
	13NiCr12	-	-	3415;3310
	-	-	35NiCrMo4	9840
	-	2506	20NiCrMo2	8620
	40NiCrMo2	-	40NiCrMo2	8740
	35CrNiMo6	2541	-	4340
	17CrNiMo7	-	14NiCrMo13	-
	14NiCrMo132	-	14NiCrMo131	-
	15Cr2	-	-	5015
	34Cr4	-	35Cr4	5132
	42Cr4	-	42Cr4	5140
	-	2245	42Cr4	5140
	16MnCr5	2511	16MnCr5	5115
	55Cr3	-	-	5155
	25CrMo4	2225	55Cr3	4130
			AM26CrMo4	
	34CrMo4	2234	34CrMo4	4137;4135
	41CrMo4	2244	42CrMo4	4140;4142
	42CrMo4	2244	42CrMo4	4140

Werkstoff-Gruppe Material group	Deutschland Germany		Großbritannien Great Britain		Frankreich France	Italien Italy
	W-Nr.	DIN	BS	EN	AFNOR	UNI
P	Baustahl und Konstruktionsstahl Constructional steels					
	1.7262	15CrMo5	-	-	12CD4	-
	1.7335	13CrMo4 4	1501-620Gr27	-	15CD3.5 15CD4.5	14CrMo4 5
	1.7361	32CrMo12	722M24	40B	30CD12	32CrMo12
	1.7380	10CrMo9 10	1501-622	-	12CD9,10	12CrMo9,10
			Gr.31;45	-	-	
	1.7715	14MoV6 3	1503-660-440	-	-	-
	1.8159	50CrV4	735A50	47	50CV4	50CrV4
	1.8509	41CrAlMo7	905M39	41B	40CAD6,12	41CrAlMo7
	1.8523	39CrMoV13 9	897M39	40C	-	36CrMoV12
	Werkzeugstähle Tool steels					
	1.1545	C105W1	-	-	Y1 105	C98KU C100KU C120KU
	1.1663	C125W	-	-	Y2 120	
	1.2067	100Cr6	BL3	-	Y100C6	-
	1.2080	X210Cr12	BD3	-	Z200C12	X210Cr13KU X250Cr12KU
	1.2344	X40CrMoV51	BH13	-	Z40CDV5	X35CrMoV05KU X40CrMoV511KU
	1.2363	X100CrMoV51	BA2	-	Z100CDV5	X100CrMoV51KU
	1.2419	105WCr6	-	-	105WC13 107WCr5KU	10WCr6
	1.2436	X210CrW12	-	-	-	X215CrW121KU
	1.2542	45WCrV7	BS1	-	-	45WCrV8KU
	1.2581	X30WCrV9 3 X30WCrV9 3KU	BH21	-	Z30WCV9	X28W09KU X30WCrV9 3KU
	1.2601	X165CrMoV12	-	-	-	X165CrMoW12KU
	1.2713	55NiCrMoV6	-	-	55NCDV7	-
	1.2833	100V1	BW2	-	Y1 105V	-
	Schnellarbeitsstähle High speed steels					
	1.3243	S 6-5-2-5	-	-	Z85WDKCV 06-05-04-02	HS 6-5-2-5
	1.3255	S 18-1-2-5	BT4	-	Z80WKCV 18-05-04-01	X78WCo1805KU
	1.3343	S 6-5-2	BM2	-	Z85WDCV 06-05-04-02	X82WMo0605KU
	1.3348	S 2-9-2	-	-	Z100WCWV 09-04-02-02	HS 2-9-2
	1.3355	S 18-0-1	BT1	-	Z80WCV 18-04-01	X75W18KU

	Belgien Belgium	Schweden Sweden	Spanien Spain	USA U.S.A.
	NBN	SS	UNE	AISI/SAE
	-	2216	12CrMo4	-
	14CrMo45	-	14CrMo45	ASTM A182 F11;F12
	32CrMo12	2240	F.124.A	-
	-	2218	TU.H	ASTM A182 F.22
	13MoCrV6	-	13MoCrV6	-
	50CrV4	2230	51CrV4	6150
	41CrAlMo7	2940	41CrAlMo7	-
	39CrMoV13	-	-	-
	-	1880	F.515 F.516 (C120)	W.110 W.112
	-	-	100Cr6	L3
	-	-	X210Cr12	D3
	-	2242	X40CrMoV5	H13
	-	2260	X100CrMoV5	A2
	-	2140	105WCr5	-
	-	2312	X210CrW12	-
	-	2710	45WCrSi8	S1
	-	-	X30WCrV9	H21
	-	2310	X160CrMoV12	-
	-	-	F.520.S	L6
	C98KU 102V2KU	-	-	W210
	-	2723	HS 6-5-2-5	-
	-	-	HS 18-1-1-5	T4
	-	2722	HS 6-5-2	M2
	-	2782	HS 2-9-2	M7
	-	-	HS 18-0-1	T1

Werkstoff-Gruppe Material group	Deutschland Germany		Großbritannien Great Britain		Frankreich France	Italien Italy
	W-Nr.	DIN	BS	EN	AFNOR	UNI
M	Rostfreie und wärmfeste Stähle Stainless and heat resisting steels					
	1.4000	X6Cr13	403S17	-	Z6C13	X6Cr13
	1.4001	X7Cr14				
	1.4006	X10Cr13	410S21	56A	Z10C14	X12Cr13
	1.4016	X6Cr17	430S15	60	Z8C17	X8Cr17
	1.4027	G-X200Cr14	420C29	56B	Z20C13M	-
	1.4034	X46Cr13	420S45	56D	Z40CM	X40Cr14
					Z38C13M	
	1.4057	X20CrNi172	431S29	57	Z15CNi6.02	X16CrNi16
	1.4104	X12CrMoS17	-	-	Z10CF17	X10CrS17
	1.4113	X6CrMo171	434S17	-	Z8CD17.01	X8CrMo17
	1.4313	X5CrNi134	425C11	-	Z4CND13.4M	-
	1.4408	G-X6CrNiMo1810	316C16	-	-	-
	1.4718	X45CrSi93	401S45	52	Z45Cs9	X45CrSi8
	1.4724	X10CrAl13	403S17	-	Z10C13	X10CrAl12
	1.4742	X10CrAl18	430S15	60	Z10CAS18	X8Cr17
	1.4747	X80CrNiSi20	443505	59	Z80CSN20.02	X8CrSiNi20
	1.4762	X10CrAl24	-	-	Z10CAS24	X16Cr26
	1.4301	X5CrNi1810	304S15	58E	Z6CN18.09	X5CrNi1810
	1.4305	X10CrNiS189	303S21	58M	Z10CNF 18.09	X10CrNiS18.09
	1.4306	X2CrNi1911	304S12	-	Z2CN 18.10	X2CrNi18.11
			304C12		Z3CN 19.10	
	1.4308	G-X6CrNi18 9	304C15	-	Z6CN18.10M	-
	1.4310	X12CrNi177	-	-	Z12CN17.07	X12CrNi1707
	1.4311	X2CrNiN1810	304S26	-	Z2CN18.10	-
	1.4401	X5CrNiMo17122	316S16	58J	Z6CND17.11	X5CrNiMo1712
	1.4429	X2CrNiMoN17133	-	-	Z2CND17.13	-
	1.4435	X2CrNiMo18143	316S12	-	Z2CND17.13	X2CrNiMo1713
	1.4438	X2CrNiMo17133	317S12	-	Z2CND1915	X2CrNiMo1816
	1.4460	X8CrNiMo275	-	-	-	-
	1.4541	X6CrNiTi1810	2337	312S12	Z6CNT18.10	X6CrNiTi1811
	1.4550	X6CrNiNb1810	347S17	58F	Z6CNNb18.10	X6CrNiNb1811
	1.4571	X6CrNiMoTi17122	320S17	58J	Z6NDT17.12	X6CrNiMoTi1712
	1.4581	G-X5CrNi MoNb1810	318C17	-	Z4CNDNb 18 12M	XG8CrNiMo1811
	1.4583	X10CrNi MoNb1812	-	-	Z6CNDNb 17 13B	X6CrNiMoNb1713
	1.4828	X15CrNiSi2012	309S24	-	Z15CNS20.12	-
	1.4845	X12CrNi25 21	310S24	-	Z12CN2520	X6CrNi2520
	1.4864	X12NiCrSi3616	-	-	Z12NCS35.16	-
	1.4865	G-X40NiCrSi3818	330C11	-	-	XG50NiCr3919
	1.4871	X53CrMnNiN219	349S54	-	Z52CMN21.09	X53CrMnNiN219
			321S12	58B		
	1.4878	X12CrNiTi189	321S20	58C	Z6CNT18.12B	X6CrNiTi1811

Belgien Belgium	Schweden Sweden	Spanien Spain	USA U.S.A.
NBN	SS	UNE	AISI/SAE
-	2301	F.3110	403
		F.8401	
-	2302	F.3401	410
-	2320	F.3113	430
-	-	-	-
-	2304	F.3405	-
-	2321	F.3427	431
-	2383	F.3117	430F
-	2325	-	434
-	-	-	-
	F.8414		
	-	F.322	HW3
-	-	F.311	405
-	-	F.3113	430
	-	F.320B	HNV6
-	2322	-	446
-	2332	F.3551	304
		F.3541	
		F.3504	
-	2346	F.3508	303
-	2352	F.3503	304L
	2333		
-	-	-	-
-	2331	F.3517	301
-	2371	-	304LN
-	2347	F.3543	316
-	2375	-	316LN
-	2353	-	316L
-	2367	-	317L
-	2324	-	329
-	58B	F.3553, F.3523	321
-	2338	F.3552, F.3524	347
-	2350	F.3535	316Ti
-	-	-	-
-	-	-	318
-			
-	-	-	309
-	2361	F.331	310S
-	-	-	330
-	-	-	-
-	-	-	EV8
-	-	F.3523	321

Werkstoff-Gruppe Material group	Deutschland Germany		Großbritannien Great Britain		Frankreich France	Italien Italy
	W-Nr.	DIN	BS	EN	AFNOR	UNI
K	Grauguss (unlegiert) Unalloyed grey cast iron					
		GG 10			Ft 10 D	
		GG 15	Grade 150		Ft 15 D	
		GG 20	Grade 220		Ft 20 D	
		GG 25	Grade 260		Ft 25 D	
		GG 30	Grade 300		R 30 D	
		GG 35	Grade 350		Ft 35 D	
		GG 40	Grade 400		Ft 40 D	
	Grauguss (legiert) Alloyed grey cast iron					
		DIN4694	3468; 1974			
		GGL-			A32-301	
		NiCr 20 2	L-NiCr 20 2		L-NC 20 2	
	Kugelgraphitguss Unalloyed nodular cast					
			2789; 1973		NF A32-201	
		GGG 40	SNG 420/12		FCS 400-12	
		GGG 40.3	SNG 370/17		FGS 370-17	
		GGG 35.3	-		-	
		GGG 50	SNG 500/7		FGS 500-7	
		GGG 60	SNG 600/3		FGS 600-3	
		GGG 70	SNG 700/2		FGS 700-2	
	Legierter Guss Alloyed cast steels					
		DIN 1694				
		GGG NiMn 13 7	L-NiMn 13 7		L-NM 13 7	
		GGG NiCr 20 2	L-NiMn 20 2		L-NC 20 2	
	Temperguss Malleable cast iron					
		-	8 290/6		MN 32-8	
		GTS-35	B 340/12		MN 35-10	
	GTS-45	P 440/7				
	GTS-55	P 510/4		MP 50-5		
	GTS-65	P 570/3		MP 60-3		
	GTS-70	P 690/2		IP 70-2		

	Belgien Belgium	Schweden Sweden	Spanien Spain	USA U.S.A.
	NBN	SS	UNE	AISI/SAE
				ASTM A48-76
		01 00		
		01 10		No 20 B
		01 15		No 25 B
		01 20		No 30 B
		01 25		No 35 B
				No 40 B
		01 30		No 45 B
		01 35		No 50 B
		01 40		No 55 B
		MB		ASTM
		ISO-215		A436-72
		05 23		Type 2
				A536-72
		07 17-02		60-40-18
		07 17-12		-
		07 17-15		-
		07 27-02		80-55-06
		07 32-03		-
		07 37-01		100-70-03
		07 72		-
		07 76		Type 2
				ASTM A47-74
				A 220-762)
		08 14		
		08 15		32510
		08 52		40010
		08 54		50005
		08 58		70003
		08 62		(002)

ISO	ANSI	ISO	ANSI
CCGT 060202	CCGT 2 (1.5) (.5)	DCGW 070202	DCGW 2 (1.5) (.5)
CCGT 060204	CCGT 2 (1.5) 1	DCGW 070204	DCGW 2 (1.5) 1
CCGT 09T302	CCGT 3 (2.5) (.5)	DCGW 11T304	DCGW 3 (2.5) 1
CCGT 09T304	CCGT 3 (2.5) 1	DCGW 11T308	DCGW 3 (2.5) 2
CCGT 120404	CCGT 431	DCMT 070202	DCMT 2 (1.5) (.5)
CCGT 120408	CCGT 432	DCMT 070204	DCMT 2 (1.5) 1
CCGW 060202	CCGW 2 (1.5) (.5)	DCMT 070208	DCMT 2 (1.5) 2
CCGW 060204	CCGW 2 (1.5) 1	DCMT 11T302	DCMT 3 (2.5) (.5)
CCGW 09T302	CCGW 3 (2.5) (.5)	DCMT 11T304	DCMT 3 (2.5) 1
CCGW 09T304	CCGW 3 (2.5) 1	DCMT 11T308	DCMT 3 (2.5) 2
CCGW 120404	CCGW 431	DCMT 150408	DCMT 432
CCGW 120408	CCGW 432	DCMT 150412	DCMT 433
CCMT 060202	CCMT 2 (1.5) (.5)	DCMW 11T304	DCMW 3 (2.5) 1
CCMT 060204	CCMT 2 (1.5) 1	DCMW 11T308	DCMW 3 (2.5) 2
CCMT 060208	CCMT 2 (1.5) 2	DNGA 150404	DNGA 431
CCMT 09T302	CCMT 3 (2.5) (.5)	DNGA 150408	DNGA 432
CCMT 09T304	CCMT 3 (2.5) 1	DNGA 150604	DNGA 441
CCMT 09T308	CCMT 3 (2.5) 2	DNGA 150608	DNGA 442
CCMT 120404	CCMT 431	DNMA 150608	DNM 442
CCMT 120408	CCMT 432	DNMG 110402	DNMG 330
CCMT 250924	CCMT 866	DNMG 110404	DNMG 331
CCMW 09T304	CCMW 3 (1.5) 1	DNMG 110408	DNMG 332
CCMW 120404	CCMW 431	DNMG 110412	DNMG 333
CCMW 120408	CCMW 432	DNMG 140405TL20	-
CNGA 120404	CNGA 431	DNMG 140405TL25	-
CNGA 120408	CNGA 432	DNMG 140405TR20	-
CNGA 120412	CNGA 433	DNMG 140405TR25	-
CNMA 120404	CNMA 431	DNMG 140410TL25	-
CNMA 120408	CNMA 432	DNMG 140410TL32	-
CNMA 120412	CNMA 433	DNMG 140410TR25	-
CNMG 090304	CNMG 321	DNMG 140410TR32	-
CNMG 090308	CNMG 322	DNMG 150404	DNMG 431
CNMG 120402	CNMG 430	DNMG 150408	DNMG 432
CNMG 120404	CNMG 431	DNMG 150412	DNMG 433
CNMG 120408	CNMG 432	DNMG 150416	DNMG 434
CNMG 120412	CNMG 433	DNMG 150604	DNMG 441
CNMG 120416	CNMG 434	DNMG 150608	DNMG 442
CNMG 160608	CNMG 542	DNMG 150612	DNMG 443
CNMG 160612	CNMG 543	DNMG 150616	DNMG 444
CNMG 160616	CNMG 544	DNMM 150408	DNMM 432
CNMG 190608	CNMG 642	DNMM 150412	DNMM 433
CNMG 190612	CNMG 643	DNMM 150608	DNMM 442
CNMG 190616	CNMG 644	DNMM 150612	DNMM 443
CNMM 120408	CNMM 432	RCGT 0602M0	-
CNMM 120412	CNMM 433	RCGT 0803M0	-
CNMM 120416	CNMM 434	RCGT 1003M0	-
CNMM 160612	CNMM 543	RCMT 0602M0	-
CNMM 160616	CNMM 544	RCMX 1003M0	-
CNMM 190612	CNMM 643	RCMX 1204M0	-
CNMM 190616	CNMM 644	RCMX 1606M0	-
CNMM 190624	CNMM 645	RCMX 2006M0	-
CNMX 120408	CNMX 432	RCMX 2507M0	-
CNMX 190612	CNMX 643	RCMX 3209M0	-
CNMX 190616	CNMX 644	SCGT 120408	SCGT 432
DCGT 070202	DCGT 2 (1.5) (.5)	SCGW 09T304	SCGW 3 (2.5) 1
DCGT 070204	DCGT 2 (1.5) 1	SCGW 09T308	SCGW 3 (2.5) 2
DCGT 11T302	DCGT 3 (2.5) (.5)	SCGW 120404	SCGW 431
DCGT 11T304	DCGT 3 (2.5) 1	SCGW 120408	SCGW 432
DCGT 11T308	DCGT 3 (2.5) 2		

ISO	ANSI	ISO	ANSI
SCMT 09T304	SCMT 3 (2.5) 1	TNMA 160404	TNMA 331
SCMT 09T308	SCMT 3 (2.5) 2	TNMA 160408	TNMA 332
SCMT 120404	SCMT 431	TNMA 160412	TNMA 333
SCMT 120408	SCMT 432	TNMA 220412	TNMA 433
SCMT 120412	SCMT 433	TNMG 160404	TNMG 331
SCMW 09T304	SCMW 3 (2.5) 1	TNMG 160408	TNMG 332
SCMW 120404	SCMW 431	TNMG 160412	TNMG 333
SNGA 120404	SNGA 431	TNMG 220408	TNMG 432
SNGA 120408	SNGA 432	TNMG 220412	TNMG 433
SNMA 120408	SNMA 432	TNMG 220416	TNMG 434
SNMA 120412	SNMA 433	TNMM 160408	TNMM 332
SNMA 190612	SNMA 643	TNMM 160412	TNMM 333
SNMA 190616	SNMA 644	TNMM 220408	TNMM 432
SNMG 090304	SNMG 321	TNMM 220412	TNMM 433
SNMG 120404	SNMG 431	TNMX 220412	TNMX 433
SNMG 120408	SNMG 432	TNUN 160408	TNUN 332
SNMG 120412	SNMG 433	TNUN 160412	TNUN 333
SNMG 120416	SNMG 434	TPGR 110304	TPGR 221
SNMG 150608	SNMG 542	TPGR 160308	TPGR 322
SNMG 150612	SNMG 543	TPMR 090204	TPMR 1.8 (1.5) 1
SNMG 150616	SNMG 544	TPMR 110304	TPMR 221
SNMG 190612	SNMG 643	TPMR 110308	TPMR 222
SNMG 190616	SNMG 644	TPMR 160304	TPMR 321
SNMM 120408	SNMM 432	TPMR 160308	TPMR 322
SNMM 120412	SNMM 433	TPMX 220412	-
SNMM 150612	SNMM 543	TPUN 110304	TPUN 221
SNMM 190612	SNMM 643	TPUN 110308	TPUN 222
SNMM 190616	SNMM 644	TPUN 160304	TPUN 321
SNMM 190624	SNMM 646	TPUN 160308	TPUN 322
SNMM 250716	SNMM 854	TPUN 160312	TPUN 323
SNMM 250724	SNMM 856	TPUN 220408	TPUN 432
SNMX 120408	SNMX 432	TPUN 220412	TPUN 433
SNMX 120412	SNMX 433	VBMT 160404	VBMT 331
SNUN 120412	SNUN 433	VBMT 160408	VBMT 332
SPMR 090304	SPMR 321	VBMT 160412	VBMT 333
SPMR 090308	SPMR 322	VCGT 110302	VCGT 220
SPMR 120304	SPMR 421	VCGT 110304	VCGT 221
SPMR 120308	SPMR 422	VCGT 160402	VCGT 330
SPMR 120312	SPMR 423	VCGT 160404	VCGT 331
SPUN 090308	SPUN 322	VCGT 160408	VCGT 332
SPUN 120304	SPUN 421	VCGT 160412	VCGT 333
SPUN 120308	SPUN 422	VCGT 220530	-
SPUN 120312	SPUN 423	VCMT 110302	VCMT 220
SPUN 150412	SPUN 533	VCMT 110304	VCMT 221
SPUN 190400	-	VCMT 160404	VCMT 331
SPUN 250620	SPUN 845	VCMT 160408	VCMT 332
TCGT 110204	TCGT 2 (1.5) 1	VCMT 160412	VCMT 333
TCGT 16T304	TCGT 3 (1.5) 1	VNMG 160404	VNMG 331
TCGW 110204	TCGW 2 (1.5) 1	VNMG 160408	VNMG 332
TCMT 110202	TCMT 2 (1.5) (.5)	VNMG 160408	VNMG 332
TCMT 110204	TCMT 2 (1.5) 1	VNMG 160412	VNMG 333
TCMT 110208	TCMT 2 (1.5) 2	VPGT 110304	VPGT 221
TCMT 16T304	TCMT 3 (2.5) 1	VPGT 160412	VPGT 333
TCMT 16T308	TCMT 3 (2.5) 2	VPGT 220516	-
TCMW 110202	TCMW 2 (1.5) (.5)	WCGT 06T302	WCGT 3 (2.5) (.5)
TCMW 110204	TCMW 2 (1.5) 1	WCGT 06T304	WCGT 3 (2.5) 1
TCMW 16T304	TCMW 3 (2.5) 1	WCGT 06T308	WCGT 3 (2.5) 2
TCMW 16T308	TCMW 3 (2.5) 2	WCGT 080404	WCGT 431
		WCGT 080408	WCGT 432

Zugfestigkeit Rm Tensile strength Rm N/mm ²	Vickers- härte Vickers hardness HV	Brinell- härte Brinell hardness HB	Rockwell- härte Rockwell hardness HRC
255	80	76	
270	85	80,7	
285	90	85,5	
305	95	90,2	
320	100	95	
335	105	99,8	
350	110	105	
370	115	109	
385	120	114	
400	125	119	
415	130	124	
430	135	128	
450	140	133	
465	145	138	
480	150	143	
495	155	147	
510	160	152	
530	165	156	
545	170	162	
560	175	166	
575	180	171	
595	185	176	
610	190	181	
625	195	185	
640	200	190	
660	205	195	
675	210	199	
690	215	204	
705	220	209	
720	225	214	
740	230	219	
755	235	223	
770	240	228	20,3
785	245	233	21,3
800	250	238	22,2
820	255	242	23,1
835	260	247	24
850	265	252	24,8
865	270	257	25,6
880	275	261	26,4
900	280	266	27,1
915	285	271	27,8
930	290	276	28,5
950	295	280	29,2
965	300	285	29,8
995	310	295	31
1030	320	304	32,2
1060	330	314	33,3
1095	340	323	34,4

Zugfestigkeit Rm Tensile strength Rm N/mm ²	Vickers- härte Vickers hardness HV	Brinell- härte Brinell hardness HB	Rockwell- härte Rockwell hardness HRC
1125	350	333	35,5
1155	360	342	36,6
1190	370	352	37,7
1220	380	361	38,8
1155	390	371	39,8
1290	400	380	40,8
1320	410	390	41,8
1350	420	399	42,7
1385	430	409	43,6
1420	440	418	44,5
1455	450	428	45,3
1485	460	437	46,1
1520	470	447	46,9
1555	480	(456)	47,7
1595	490	(466)	48,4
1630	500	(475)	49,1
1665	510	(485)	49,8
1700	520	(494)	50,5
1740	530	(504)	51,1
1775	540	(513)	51,7
1810	550	(523)	52,3
1845	560	(532)	53,0
1880	570	(542)	53,6
1920	580	(551)	54,1
1955	590	(561)	54,7
1995	600	(570)	55,2
2030	610	(580)	55,7
2070	620	(589)	56,3
2105	630	(599)	56,8
2145	640	(608)	57,3
2180	650	(618)	57,8
	660		58,3
	670		58,8
	680		59,2
	690		59,7
	700		60,1
	720		61
	740		61,8
	760		62,5
	780		63,3
	800		64
	820		64,7
	840		65,3
	860		65,9
	880		66,4
	900		67
	920		67,5
	940		68

Zugfestigkeit Tensile strength	N/mm ²	Rm
Vickershärte Vickers hardness	Diamantpyramide 136 , Prüfkraft F ≥ 98 N Diamond pyramid 136 , Test force F ≥ 98 N	HV
Brinellhärte Brinell hardness	0,102 x F/D ² = 30 N/mm ²	HB
Kalkuliert mit: Calculated from: HB = 0,95 x HV	F = Prüfkraft in N, D = Kegeldurchmesser in mm F = Test force in N, D = Cone diameter in mm	
Härte Rockwell C Hardness Rockwell C	Diamantkegel 120°, Gesamtprüfkraft 1471 ± 9 N Diamond cone 120°, Total test force 1471 ± 9 N	HRC

