



**VHM-FRÄSWERKZEUGE**  
SOLID CARBIDE MILLS

**2020/2021**



**DAS WERKZEUG  
HORN TOOLS**

## Die neuen Kataloge von HORN – Maßstäbe für Ihre Produktivität

Von der Einzelteil- bis zur Serienfertigung, bei Standard- oder Sonderanwendungen: Unsere Werkzeuge bieten Ihnen schnelle, wirtschaftliche und qualitativ hochwertige Lösungen.

Die aktuellen HORN-Kataloge sind in folgende Themen aufgegliedert:

- Stechdrehen
- Supermini und Mini Innenbearbeitung
- Modulare Haltersysteme
- Hochharte Schneidstoffe
- Frässysteme
- Bohren und Reiben
- VHM-Fräswerkzeuge
- Boehlerit Drehen
- Boehlerit Fräsen

Bei der Wahl der individuellen Schnittparameter unterstützen Sie unsere Tabellen mit praxiserprobten Erfahrungswerten. Nutzen Sie das Fachwissen unserer Innen- und Außendienstmitarbeiter. Denn wir kennen den Markt und haben für Ihre Aufgaben und Herausforderungen die passenden Lösungen.



Lothar Horn  
Geschäftsführer  
Paul Horn GmbH



Markus Horn  
Geschäftsführer  
Paul Horn GmbH



Matthias Rommel  
Geschäftsführer  
Paul Horn GmbH

## New catalogues from HORN - benchmarks for productivity

From single part to series production, for standard or special applications: our tools offer you fast, economical and high quality solutions.

The current HORN catalogues are divided into the following sections:

- Grooving
- Supermini & Mini Internal Machining
- Modular Holder Systems
- Ultra Hard Cutting Materials
- Milling Systems
- Drilling / Reaming
- Solid Carbide Mills
- Milling Catalogue Boehlerit
- Turning Catalogue Boehlerit

To assist you when choosing cutting parameters, our tables provide proven empirical values. Take advantage of the expertise of our office staff and sales engineers, because we know the market well and have the right solutions for your applications and challenges.



Lothar Horn  
Geschäftsführer  
Paul Horn GmbH



Markus Horn  
Geschäftsführer  
Paul Horn GmbH



Matthias Rommel  
Geschäftsführer  
Paul Horn GmbH

## **A System DP**

Vollhartmetall-Schaftfräser für alle gängigen Stahlwerkstoffe  
Solid Carbide End Mills for all common steel materials

## **B System DS**

Vollhartmetall-Schaftfräser für:

- hochfeste Stähle
- gehärtete Stähle
- Kobalt-Chrom-Legierungen
- Titan
- Aluminium

Solid Carbide End Mills for:

- high tensile steels
- hardened steels
- Cobalt Chromium Steels
- Titanium
- Aluminium

## **C System DG**

Fräserschäfte mit wechselbaren Schneidköpfen für:

- Bohrnutenfräsen
- Fasen und Anbohren
- Kopierfräsen
- Hochvorschubsfräsen
- Verzahnungsfräsen

Milling shanks with exchangeable cutter heads for:

- Centre Cutting and Groove Milling
- Chamfering and Centering
- Copy Milling
- High Feed Milling
- Gear Milling

## **D Toodle Schnellaufspindeln**

Toodle High Speed Spindle



	Werkstoff	Material			Härte / Hardness
<b>P1.1</b>	Kohlenstoffstahl	Carbon steel	0,2% C		140 HB
<b>P1.2</b>	Kohlenstoffstahl	Carbon steel	0,4% C		180 HB
<b>P1.3</b>	Kohlenstoffstahl	Carbon steel	0,6% C		200 HB
<b>P2.1</b>	Legierter Stahl	Alloyed steel	geglüht	annealed	180 HB
<b>P2.2</b>	Legierter Stahl	Alloyed steel	vergütet	quenched	280 HB
<b>P2.3</b>	Legierter Stahl	Alloyed steel	vergütet	quenched	350 HB
<b>P3.1</b>	hochlegierter Stahl	high alloyed steel	geglüht	annealed	200 HB
<b>P3.2</b>	hochlegierter Stahl	high alloyed steel	vergütet	quenched	325 HB
<b>M1.1</b>	Rostfreier Stahl	Stainless steel	martensitisch, ferritisch	martensitic, ferritic	200 HB
<b>M2.1</b>	Rostfreier Stahl	Stainless steel	austenitisch	austenitic	180 HB
<b>M3.1</b>	Rostfreier Stahl	Stainless steel	austenitisch, ferritisch	austenitic, ferritic	260 HB
<b>K1.1</b>	Grauguss	Grey cast iron	niedrige Festigkeit	low tensile strength	180 HB
<b>K1.2</b>	Grauguss	Grey cast iron	hohe Festigkeit	high tensile strength	250 HB
<b>K2.1</b>	Kugelgraphitguss	Spheroidal graphite cast iron	ferritisch	ferritic	160 HB
<b>K2.2</b>	Kugelgraphitguss	Spheroidal graphite cast iron	perlitisch	perlitic	250 HB
<b>K3.1</b>	Temperguss	Malleable cast iron	ferritisch	ferritic	125 HB
<b>K3.2</b>	Temperguss	Malleable cast iron	perlitisch	perlitic	225 HB
<b>N1.1</b>	Aluminium-Legierungen	Aluminum alloys	nicht vergütbar	not heat treatable	80 HB
<b>N1.2</b>	Aluminium-Legierungen	Aluminum alloys	vergütbar	heat treatable	120 HB
<b>N2.1</b>	Aluminiumguss	cast Aluminum	< 6% Si	< 6% Si	
<b>N2.2</b>	Aluminiumguss	cast Aluminum	6 - 10% Si	6 - 10% Si	
<b>N2.3</b>	Aluminiumguss	cast Aluminum	10 - 15% Si	10 - 15% Si	
<b>N3.1</b>	Kupfer-Legierungen	Copper alloys	nicht vergütbar	not heat treatable	90 HB
<b>N3.2</b>	Kupfer-Legierungen	Copper alloys	vergütbar	heat treatable	100 HB
<b>N4.1</b>	Kunststoffe	Synthetics			
<b>S1.1</b>	Titan-Legierungen	Titanium alloys			280 HB
<b>S2.1</b>	Nickel-Basis-Legierung	Nickel-base alloys			450 HB
<b>S3.1</b>	Cobalt-Basis-Legierung	Cobalt-base alloys			450 HB
<b>H1.1</b>	Gehärtete Stähle	hardened steels			50-55 HRC
<b>H1.2</b>	Gehärtete Stähle	hardened steels			56-59 HRC
<b>H1.3</b>	Gehärtete Stähle	hardened steels			60-63 HRC
<b>H1.4</b>	Gehärtete Stähle	hardened steels			> 63 HRC

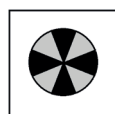

Zentrumsschneidend  
Centre cutting

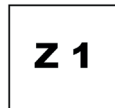

**Z 1**

Zähnezahl  
Number of teeth

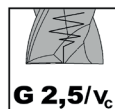

**G 2,5/v<sub>c</sub>**

Wuchtgüte  
Balance quality

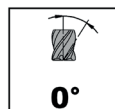

**0°**

Drallwinkel  
Helix angle

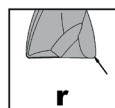

**r**

Eckenradius  
Corner radius



**r<sub>th</sub>**

Radius theoretisch  
Radius theoretic

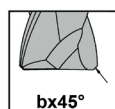

**bx45°**

Eckfase  
Corner chamfer

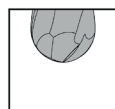

Vollradius  
Full radius

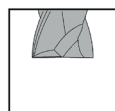

Scharfkantig  
Sharp



Vollnut  
Slot milling



Eckfräsen  
Corner milling



Kopierfräsen  
Copy milling

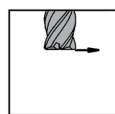

Eintauchen horizontal  
Diving horizontal

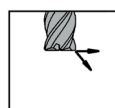

Eintauchen, Rampe, Helix,  
Diving, ramping, helical

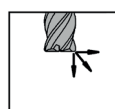

Eintauchen, Rampe, Helix, vertikal  
Diving, ramping, helical, vertical

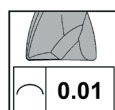

**0.01**

Formtoleranz  
Form tolerance



**øh11**

Toleranz  
Tolerance

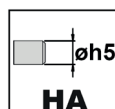

**øh5**

**HA**

Schaft DIN 6535 HA  
Shank DIN 6535 HA

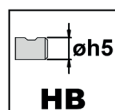

**øh5**

**HB**

Schaft DIN 6535 HB  
Shank DIN 6535 HB

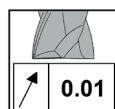

**0.01**

Rundlauf  
Run-out



**IK**

Innenkühlung  
Internal cooling

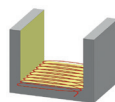







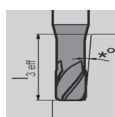







Trochoidalfräsen  
Trochoidal milling



Eintauchen  
Diving



Effektive Nutzlänge  
Effective neck length

	DPSG.3	Schruppfräser Roughing End Mill	Ø 2 – Ø 20	Z 3	A4 – A5
	DPSG.4	Schruppfräser Roughing End Mill	Ø 2 – Ø 20	Z 4	A6 – A7
	DPSV	Schafffräser HPC End Mill HPC	Ø 4 – Ø 20	Z 4	A8 – A9
	DPX	Schafffräser HPC End Mill HPC	Ø 3 – Ø 16	Z 4	A10 – A13
	DPSB	Schruppfräser, Spanbrecher Roughing End Mill, chip breaker	Ø 4 – Ø 20	Z 4	A14 – A15
	DPS	Kordelschruppfräser Roughing End Mill with ripper profile	Ø 4 – Ø 20	Z 3-6	A16 – A17
	DPT	Schafffräser, scharfkantig End Mill, sharp	Ø 1 – Ø 16	Z 4	A18 – A19
	DPTR.2	Torusfräser Torus End Mill	Ø 3 – Ø 20	Z 2	A20 – A21
	DPTR.4	Torusfräser Torus End Mill	Ø 3 – Ø 20	Z 4	A22 – A23
	DPM	Schafffräser Mehrschneider End Mill multiple fluted	Ø 6 – Ø 20	Z 6-8	A24 – A25
	DPK.2	Schafffräser Vollradius Ball Nose End Mill	Ø 1 – Ø 16	Z 2	A26 – A27
	DPK.3	Schafffräser Vollradius Ball Nose End Mill	Ø 1,5 – Ø 20	Z 3	A28 – A29
	DPK.4	Schafffräser Vollradius Ball Nose End Mill	Ø 1 – Ø 20	Z 4	A30 – A31
	DPFF	Fasfräser Chamfering End Mill	Ø 4 – Ø 12	Z 4	A32 – A33

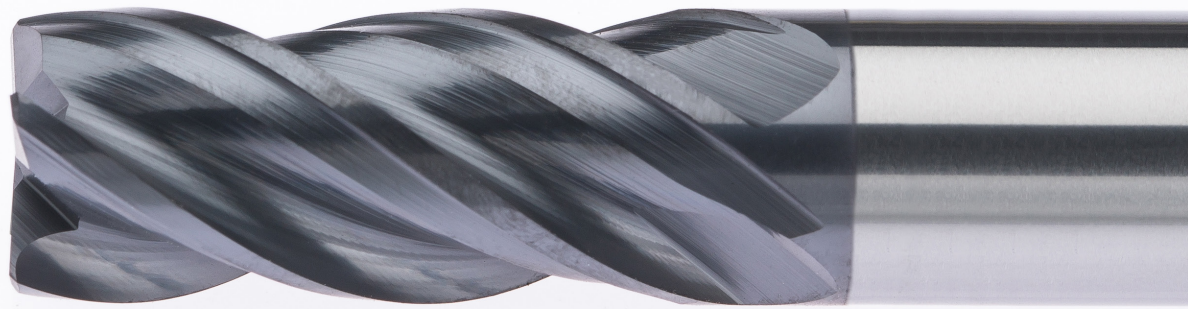

**Vollhartmetall-Schaftfräser**

abgestimmt für:

- alle gängigen Stahlwerkstoffe

**Solid Carbide End Mills**

designed for:

- all common steel materials



### DPSG

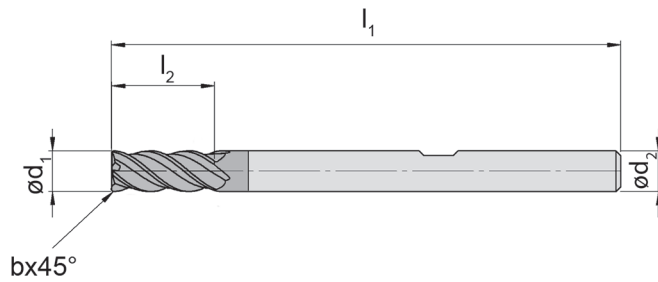
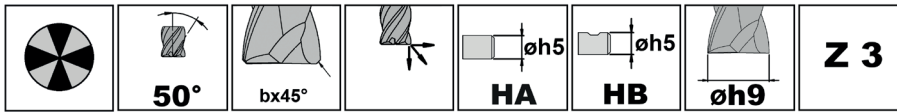

Bestellnummer Part number	d <sub>1</sub>	b	l <sub>2</sub>	d <sub>2</sub>	l <sub>1</sub>	Z	Ausführung Version	TF2K
DPSG.3.02.010.03.08	2	0,10	8	3	40	3	HA	▲
DPSG.3.03.010.03.10	3	0,10	10	3	40	3	HA	▲
DPSG.3.04.010.04.12	4	0,10	12	4	50	3	HA	▲
DPSG.3.05.015.05.15	5	0,15	15	5	50	3	HA	▲
DPSG.3.06.015.06.15	6	0,15	15	6	65	3	HB	▲
DPSG.3.08.020.08.20	8	0,20	20	8	65	3	HB	▲
DPSG.3.10.020.10.22	10	0,20	22	10	70	3	HB	▲
DPSG.3.12.025.12.25	12	0,25	25	12	80	3	HB	▲
DPSG.3.16.025.16.35	16	0,25	35	16	90	3	HB	▲
DPSG.3.20.025.20.40	20	0,25	40	20	102	3	HB	▲

▲ ab Lager / on stock Δ 4 Wochen / 4 weeks x auf Anfrage / upon request

● empfohlen / recommended

o bedingt einsetzbar / alternative recommendation

- nicht geeignet / not suitable

■ unbeschichtete HM-Sorten / uncoated grades

■ beschichtete HM-Sorten / coated grades

■ bestückt/Cermet / brazed/Cermet

Abmessungen in mm

Dimensions in mm

P	●
M	○
K	○
N	○
S	○
H	-

HM-Sorten  
Carbide grades



# Schnittdaten DPSG Ø 2 - 20 mm

## Cutting Data DPSG Ø 2 - 20 mm

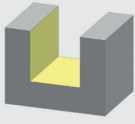
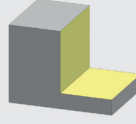

A

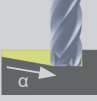
	 $v_c = \text{m/min}$	 $v_c = \text{m/min}$
P1.1	130	160
P1.2	120	140
P1.3	120	140
P2.1	110	130
P2.2	110	130
P2.3	110	130
P3.1	100	120
P3.2	100	120

$d_1$							
		$f_z$	$a_e$	$a_p$	$f_z$	$a_e$	$a_p$
2	5°	0,007	2	2	0,011	0,50	4,00
3	5°	0,011	3	3	0,017	0,75	6,00
4	5°	0,015	4	4	0,024	1,00	8,00
5	5°	0,019	5	5	0,030	1,25	10,00
6	5°	0,023	6	6	0,037	1,50	12,00
8	5°	0,031	8	8	0,050	2,00	16,00
10	5°	0,039	10	10	0,062	2,50	20,00
12	5°	0,047	12	12	0,075	3,00	24,00
16	5°	0,063	16	16	0,101	4,00	32,00
20	5°	0,079	20	20	0,127	5,00	40,00

Abmessungen in mm  
Dimensions in mm

### DPSG

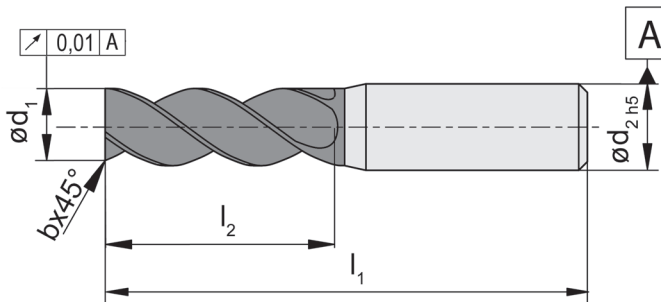
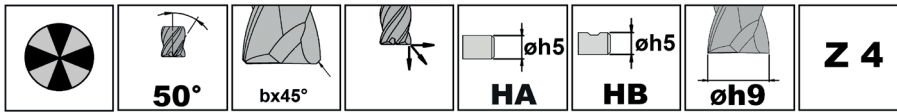

Bestellnummer Part number	d <sub>1</sub>	b	l <sub>2</sub>	d <sub>2</sub>	l <sub>1</sub>	Z	Ausführung Version	TF2K
DPSG.4.03.010.03.10	3	0,10	10	3	40	4	HA	▲
DPSG.4.04.010.04.12	4	0,10	12	4	50	4	HA	▲
DPSG.4.05.015.05.15	5	0,15	15	5	50	4	HA	▲
DPSG.4.06.015.06.15	6	0,15	15	6	65	4	HB	▲
DPSG.4.08.020.08.20	8	0,20	20	8	65	4	HB	▲
DPSG.4.10.020.10.22	10	0,20	22	10	70	4	HB	▲
DPSG.4.12.025.12.25	12	0,25	25	12	80	4	HB	▲
DPSG.4.16.025.16.35	16	0,25	35	16	90	4	HB	▲
DPSG.4.20.025.20.40	20	0,25	42	20	102	4	HB	▲

▲ ab Lager / on stock Δ 4 Wochen / 4 weeks x auf Anfrage / upon request

● empfohlen / recommended

o bedingt einsetzbar / alternative recommendation

- nicht geeignet / not suitable

■ unbeschichtete HM-Sorten / uncoated grades

■ beschichtete HM-Sorten / coated grades

■ bestückt/Cermet / brazed/Cermet

Abmessungen in mm

Dimensions in mm

P	●
M	○
K	○
N	○
S	○
H	-

HM-Sorten  
Carbide grades



# Schnittdaten DPSG Ø 3 - 20 mm

## Cutting Data DPSG Ø 3 - 20 mm

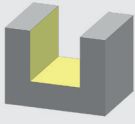
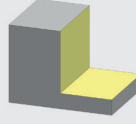

A

	 $v_c = \text{m/min}$	 $v_c = \text{m/min}$
P1.1	130	160
P1.2	120	140
P1.3	120	140
P2.1	110	130
P2.2	110	130
P2.3	110	130
P3.1	100	120
P3.2	100	120

$d_1$							
		$f_z$	$a_e$	$a_p$	$f_z$	$a_e$	$a_p$
3	4°	0,007	3	3	0,010	0,75	4,00
4	4°	0,011	4	4	0,017	1,00	6,00
5	4°	0,015	5	5	0,023	1,25	8,00
6	4°	0,019	6	6	0,030	1,50	10,00
8	4°	0,027	8	8	0,043	2,00	12,00
10	4°	0,035	10	10	0,055	2,50	16,00
12	4°	0,043	12	12	0,068	3,00	20,00
16	4°	0,059	16	16	0,094	4,00	24,00
20	4°	0,075	20	20	0,120	5,00	32,00
20	5°	0,079	20	20	0,127	5,00	40,00

Abmessungen in mm  
Dimensions in mm



### DPSV

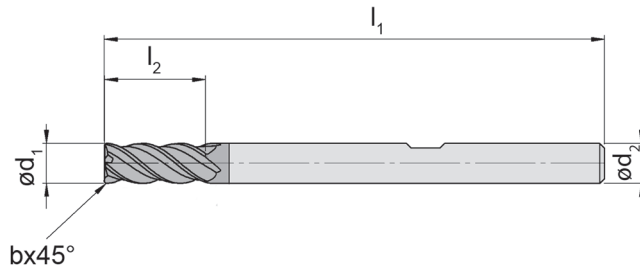
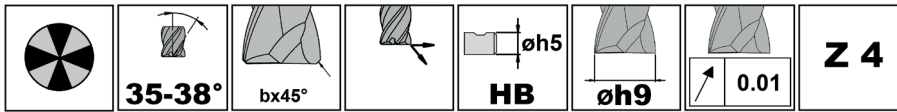

Bestellnummer Part number	d <sub>1</sub>	b	l <sub>2</sub>	d <sub>2</sub>	l <sub>1</sub>	Z	Ausführung Version	TF2K
DPSV.4.04.025.06.11	4	0,25	11	6	57	4	HB	▲
DPSV.4.05.025.06.13	5	0,25	13	6	57	4	HB	▲
DPSV.4.06.025.06.13	6	0,25	13	6	57	4	HB	▲
DPSV.4.08.025.08.19	8	0,25	19	8	63	4	HB	▲
DPSV.4.10.025.10.22	10	0,25	22	10	72	4	HB	▲
DPSV.4.12.025.12.26	12	0,25	26	12	83	4	HB	▲
DPSV.4.16.025.16.32	16	0,25	32	16	92	4	HB	▲
DPSV.4.20.040.20.38	20	0,40	38	20	104	4	HB	▲

▲ ab Lager / on stock Δ 4 Wochen / 4 weeks x auf Anfrage / upon request

● empfohlen / recommended

o bedingt einsetzbar / alternative recommendation

- nicht geeignet / not suitable

■ unbeschichtete HM-Sorten / uncoated grades

■ beschichtete HM-Sorten / coated grades

■ bestückt/Cermet / brazed/Cermet

Abmessungen in mm

Dimensions in mm

P	●
M	○
K	○
N	○
S	○
H	-

HM-Sorten  
Carbide grades



# Schnittdaten DPSV Ø 4 - 20 mm

## Cutting Data DPSV Ø 4 - 20 mm

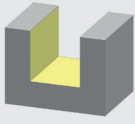
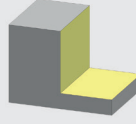

A

	 $v_c = \text{m/min}$	 $v_c = \text{m/min}$
P1.1	150	180
P1.2	140	170
P1.3	130	160
P2.1	120	140
P2.2	120	140
P2.3	110	130
P3.1	110	130
P3.2	110	130

$d_1$							
		$f_z$	$a_e$	$a_p$	$f_z$	$a_e$	$a_p$
4	4°	0,011	4	4	0,017	1,00	8,00
5	4°	0,015	5	5	0,023	1,25	10,00
6	4°	0,019	6	6	0,030	1,50	12,00
8	4°	0,027	8	8	0,043	2,00	16,00
10	4°	0,035	10	10	0,055	2,50	20,00
12	4°	0,043	12	12	0,068	3,00	24,00
16	4°	0,059	16	16	0,094	4,00	32,00
20	4°	0,075	20	20	0,120	5,00	38,00

Abmessungen in mm  
Dimensions in mm

# DPX

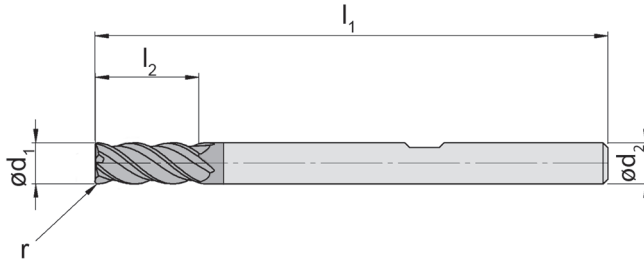
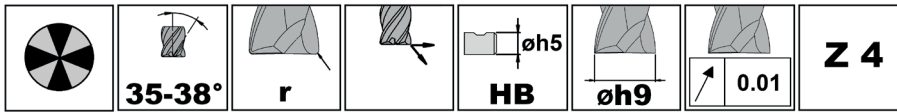

Bestellnummer Part number	d <sub>1</sub>	r	l <sub>2</sub>	d <sub>2</sub>	l <sub>1</sub>	Z	Ausführung Version	TF2K
DPX.4.03.025.06.11	3	0,25	11	6	57	4	HB	▲
DPX.4.03.050.06.13	3	0,50	11	6	57	4	HB	▲
DPX.4.04.050.06.13	4	0,50	13	6	57	4	HB	▲
DPX.4.05.050.06.13	5	0,50	13	6	57	4	HB	▲
DPX.4.06.050.06.13	6	0,50	13	6	57	4	HB	▲
DPX.4.06.100.06.13	6	1,00	13	6	57	4	HB	▲
DPX.4.06.150.06.13	6	1,50	13	6	57	4	HB	▲
DPX.4.08.050.08.19	8	0,50	19	8	63	4	HB	▲
DPX.4.08.100.08.19	8	1,00	19	8	63	4	HB	▲
DPX.4.08.150.08.19	8	1,50	19	8	63	4	HB	▲
DPX.4.10.050.10.22	10	0,50	22	10	72	4	HB	▲
DPX.4.10.100.10.22	10	1,00	22	10	72	4	HB	▲
DPX.4.10.150.10.22	10	1,50	22	10	72	4	HB	▲
DPX.4.12.050.12.26	12	0,50	26	12	83	4	HB	▲
DPX.4.12.150.12.26	12	1,50	26	12	83	4	HB	▲
DPX.4.16.150.16.32	16	1,50	32	16	92	4	HB	▲
DPX.4.16.300.16.32	16	3,00	32	16	92	4	HB	▲

▲ ab Lager / on stock Δ 4 Wochen / 4 weeks x auf Anfrage / upon request

● empfohlen / recommended

o bedingt einsetzbar / alternative recommendation

- nicht geeignet / not suitable

■ unbeschichtete HM-Sorten / uncoated grades

■ beschichtete HM-Sorten / coated grades

■ bestückt/Cermet / brazed/Cermet

Abmessungen in mm

Dimensions in mm

P	•
M	○
K	○
N	○
S	○
H	-

HM-Sorten  
Carbide grades



# Schnittdaten DPX Ø 3 - 16 mm

Cutting Data DPX Ø 3 - 16 mm

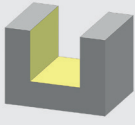
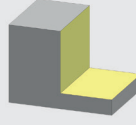

A

	 $v_c = \text{m/min}$	 $v_c = \text{m/min}$
P1.1	150	180
P1.2	140	170
P1.3	130	160
P2.1	120	140
P2.2	120	140
P2.3	110	130
P3.1	110	130
P3.2	110	130

$d_1$							
		$f_z$	$a_e$	$a_p$	$f_z$	$a_e$	$a_p$
3	3°	0,007	3	3	0,010	0,75	6,00
3	3°	0,007	3	3	0,010	0,75	6,00
4	4°	0,011	4	4	0,017	1,00	8,00
5	4°	0,015	5	5	0,023	1,25	10,00
6	4°	0,019	6	6	0,030	1,50	12,00
6	4°	0,019	6	6	0,030	1,50	12,00
6	4°	0,019	6	6	0,030	1,50	12,00
8	4°	0,027	8	8	0,043	2,00	16,00
8	4°	0,027	8	8	0,043	2,00	16,00
8	4°	0,027	8	8	0,043	2,00	16,00
10	4°	0,035	10	10	0,055	2,50	20,00
10	4°	0,035	10	10	0,055	2,50	20,00
10	4°	0,035	10	10	0,055	2,50	20,00
12	4°	0,043	12	12	0,068	3,00	24,00
12	4°	0,043	12	12	0,068	3,00	24,00
16	4°	0,059	16	16	0,094	4,00	32,00
16	4°	0,059	16	16	0,094	4,00	32,00

Abmessungen in mm

Dimensions in mm



### DPX

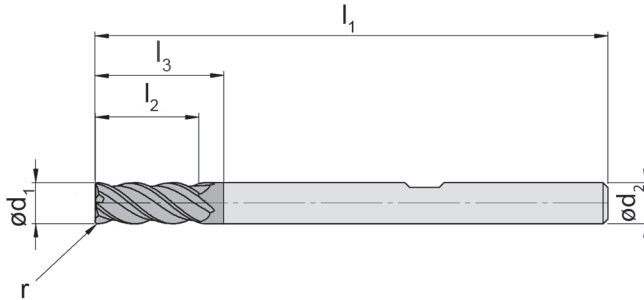
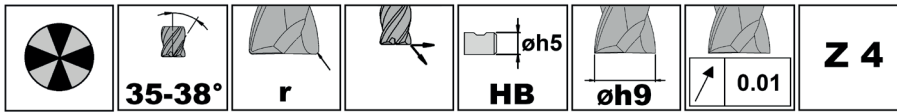

Bestellnummer Part number	d <sub>1</sub>	r	l <sub>2</sub>	l <sub>3</sub>	d <sub>2</sub>	l <sub>1</sub>	Z	Ausführung Type	TF2K
DPX.4.03.025.06.A21	3	0,25	11	21	6	57	4	HB	▲
DPX.4.03.050.06.A21	3	0,50	13	21	6	57	4	HB	▲
DPX.4.04.050.06.A21	4	0,50	13	21	6	57	4	HB	▲
DPX.4.05.050.06.A21	5	0,50	13	21	6	57	4	HB	▲
DPX.4.06.050.06.A21	6	0,50	13	21	6	57	4	HB	▲
DPX.4.06.100.06.A21	6	1,00	13	21	6	57	4	HB	▲
DPX.4.06.150.06.A21	6	1,50	13	21	6	57	4	HB	▲
DPX.4.08.050.08.A28	8	0,50	19	28	8	63	4	HB	▲
DPX.4.08.100.08.A28	8	1,00	19	28	8	63	4	HB	▲
DPX.4.08.150.08.A28	8	1,50	19	28	8	63	4	HB	▲
DPX.4.10.050.10.A32	10	0,50	22	32	10	72	4	HB	▲
DPX.4.10.100.10.A32	10	1,00	22	32	10	72	4	HB	▲
DPX.4.10.150.10.A32	10	1,50	22	32	10	72	4	HB	▲
DPX.4.12.050.12.A38	12	0,50	26	38	12	83	4	HB	▲
DPX.4.12.150.12.A38	12	1,50	26	38	12	83	4	HB	▲
DPX.4.16.150.16.A44	16	1,50	32	44	16	92	4	HB	▲
DPX.4.16.300.16.A44	16	3,00	32	44	16	92	4	HB	▲

▲ ab Lager / on stock Δ 4 Wochen / 4 weeks x auf Anfrage / upon request

● empfohlen / recommended

o bedingt einsetzbar / alternative recommendation

- nicht geeignet / not suitable

■ unbeschichtete HM-Sorten / uncoated grades

■ beschichtete HM-Sorten / coated grades

■ bestückt/Cermet / brazed/Cermet

Abmessungen in mm

Dimensions in mm

P	●
M	○
K	○
N	○
S	○
H	-

HM-Sorten  
Carbide grades



# Schnittdaten DPX Ø 3 - 16 mm

Cutting Data DPX Ø 3 - 16 mm

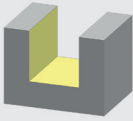
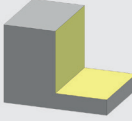

A

	 $v_c = \text{m/min}$	 $v_c = \text{m/min}$
P1.1	150	180
P1.2	140	170
P1.3	130	160
P2.1	120	140
P2.2	120	140
P2.3	110	130
P3.1	110	130
P3.2	110	130

$d_1$							
		$f_z$	$a_e$	$a_p$	$f_z$	$a_e$	$a_p$
3	3°	0,007	3	3	0,010	0,75	6,00
3	3°	0,007	3	3	0,010	0,75	6,00
4	4°	0,011	4	4	0,017	1,00	8,00
5	4°	0,015	5	5	0,023	1,25	10,00
6	4°	0,019	6	6	0,030	1,50	12,00
6	4°	0,019	6	6	0,030	1,50	12,00
6	4°	0,019	6	6	0,030	1,50	12,00
8	4°	0,027	8	8	0,043	2,00	16,00
8	4°	0,027	8	8	0,043	2,00	16,00
8	4°	0,027	8	8	0,043	2,00	16,00
10	4°	0,035	10	10	0,055	2,50	20,00
10	4°	0,035	10	10	0,055	2,50	20,00
10	4°	0,035	10	10	0,055	2,50	20,00
12	4°	0,043	12	12	0,068	3,00	24,00
12	4°	0,043	12	12	0,068	3,00	24,00
16	4°	0,059	16	16	0,094	4,00	32,00
16	4°	0,059	16	16	0,094	4,00	32,00

Abmessungen in mm  
Dimensions in mm

# A Schruppfräser, Spanbrecher

## Roughing End Mill, chip breaker



### DPSB

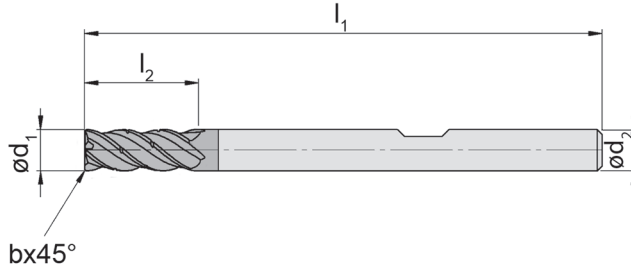
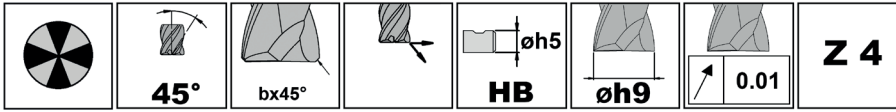

Bestellnummer Part number	d <sub>1</sub>	b	l <sub>2</sub>	d <sub>2</sub>	l <sub>1</sub>	Z	Ausführung Version	TF2K
DPSB.4.04.025.06.11	4	0,25	11	6	57	4	HB	▲
DPSB.4.06.025.06.13	6	0,25	13	6	57	4	HB	▲
DPSB.4.08.025.08.19	8	0,25	19	8	63	4	HB	▲
DPSB.4.10.025.10.22	10	0,25	22	10	72	4	HB	▲
DPSB.4.12.025.12.26	12	0,25	26	12	83	4	HB	▲
DPSB.4.16.025.16.32	16	0,25	32	16	92	4	HB	▲
DPSB.4.20.040.20.38	20	0,40	38	20	104	4	HB	▲

▲ ab Lager / on stock Δ 4 Wochen / 4 weeks x auf Anfrage / upon request

● empfohlen / recommended

o bedingt einsetzbar / alternative recommendation

- nicht geeignet / not suitable

□ unbeschichtete HM-Sorten / uncoated grades

■ beschichtete HM-Sorten / coated grades

■ bestückt/Cermet / brazed/Cermet

Abmessungen in mm

Dimensions in mm

P	●
M	○
K	○
N	○
S	○
H	-

HM-Sorten  
Carbide grades



# Schnittdaten DPSB Ø 4 - 20 mm

## Cutting Data DPSB Ø 4 - 20 mm

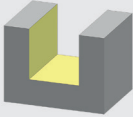
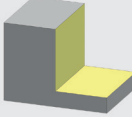

A

	 $v_c = \text{m/min}$	 $v_c = \text{m/min}$
P1.1	130	160
P1.2	120	140
P1.3	120	140
P2.1	110	130
P2.2	110	130
P2.3	110	130
P3.1	100	120
P3.2	100	120

$d_1$	 $\alpha$						
		$f_z$	$a_e$	$a_p$	$f_z$	$a_e$	$a_p$
4	4°	0,011	4	4	0,015	1,20	8,00
6	4°	0,019	6	6	0,027	1,80	12,00
8	4°	0,027	8	8	0,039	2,40	16,00
10	4°	0,035	10	10	0,051	3,00	20,00
12	4°	0,043	12	12	0,062	3,60	24,00
16	4°	0,059	16	16	0,086	4,80	32,00
20	4°	0,075	20	20	0,110	6,00	38,00

Abmessungen in mm  
Dimensions in mm

# Kordelschruppfräser

## Roughing End Mill with ripper profile

### DPS

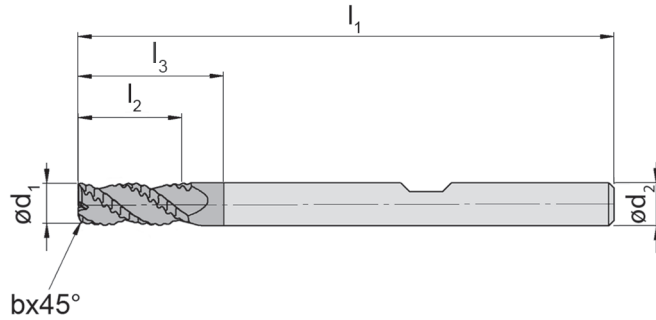
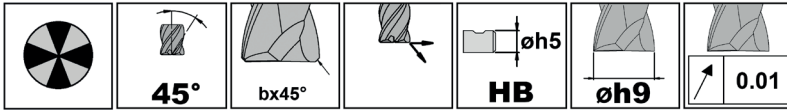

Bestellnummer Part number	d <sub>1</sub>	b	l <sub>2</sub>	l <sub>3</sub>	d <sub>2</sub>	l <sub>1</sub>	Z	Ausführung Version	TF2K
DPS.3.04.025.06.11	4	0,25	11	-	6	57	3	HB	▲
DPS.4.05.025.06.13	5	0,25	13	-	6	57	4	HB	▲
DPS.4.06.025.06.13	6	0,25	13	-	6	57	4	HB	▲
DPS.4.06.025.06.A21	6	0,25	13	21	6	57	4	HB	▲
DPS.4.08.025.08.19	8	0,25	19	-	8	63	4	HB	▲
DPS.4.08.025.08.A27	8	0,25	19	27	8	63	4	HB	▲
DPS.4.10.025.10.22	10	0,25	22	-	10	72	4	HB	▲
DPS.4.10.025.10.A32	10	0,25	22	32	10	72	4	HB	▲
DPS.4.12.025.12.26	12	0,25	26	-	12	83	4	HB	▲
DPS.4.12.025.12.A38	12	0,25	26	38	12	83	4	HB	▲
DPS.5.16.025.16.32	16	0,25	32	-	16	92	5	HB	▲
DPS.5.16.025.16.A44	16	0,25	32	44	16	92	5	HB	▲
DPS.6.20.040.20.38	20	0,40	38	-	20	104	6	HB	▲
DPS.6.20.040.20.A54	20	0,40	38	54	20	104	6	HB	▲

▲ ab Lager / on stock Δ 4 Wochen / 4 weeks x auf Anfrage / upon request

● empfohlen / recommended

o bedingt einsetzbar / alternative recommendation

- nicht geeignet / not suitable

■ unbeschichtete HM-Sorten / uncoated grades

■ beschichtete HM-Sorten / coated grades

■ bestückt/Cermet / brazed/Cermet

Abmessungen in mm

Dimensions in mm

P	●
M	○
K	○
N	○
S	○
H	-

HM-Sorten  
Carbide grades



# Schnittdaten DPS Ø 4 - 20 mm

## Cutting Data DPS Ø 4 - 20 mm

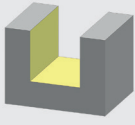
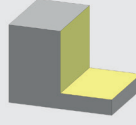

A

	 $v_c = \text{m/min}$	 $v_c = \text{m/min}$
P1.1	130	160
P1.2	120	140
P1.3	120	140
P2.1	110	130
P2.2	110	130
P2.3	110	130
P3.1	100	120
P3.2	100	120

$d_1$							
		$f_z$	$a_e$	$a_p$	$f_z$	$a_e$	$a_p$
4	4°	0,011	4	4	0,013	1,60	8,00
5	4°	0,015	5	5	0,018	2,00	10,00
6	4°	0,019	6	6	0,023	2,40	12,00
6	4°	0,019	6	6	0,023	2,40	12,00
8	4°	0,027	8	8	0,034	3,20	16,00
8	4°	0,027	8	8	0,034	3,20	16,00
10	4°	0,035	10	10	0,044	4,00	20,00
10	4°	0,035	10	10	0,044	4,00	20,00
12	4°	0,043	12	12	0,054	4,80	24,00
12	4°	0,043	12	12	0,054	4,80	24,00
16	3°	0,057	16	16	0,071	6,40	32,00
16	3°	0,057	16	16	0,071	6,40	32,00
20	3°	0,072	20	20	0,089	8,00	38,00
20	3°	0,072	20	20	0,089	8,00	38,00

Abmessungen in mm  
Dimensions in mm

# A Schafffräser, scharfkantig

## End Mill, sharp



### DPT

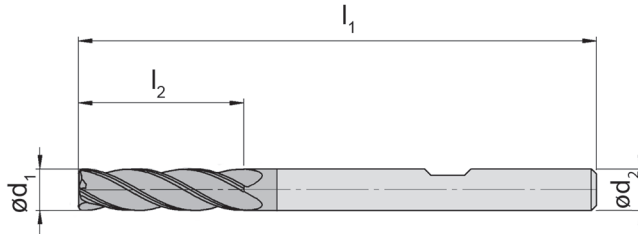
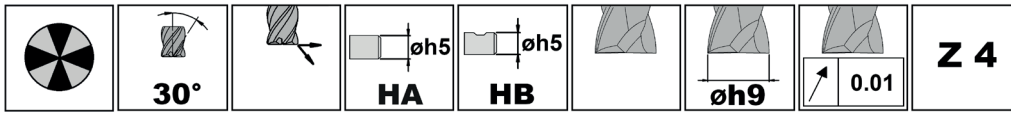

Bestellnummer Part number	d <sub>1</sub>	l <sub>2</sub>	d <sub>2</sub>	l <sub>1</sub>	Z	Ausführung Version	TF2K
DPT.4.01.00.03.03	1,0	3	3	40	4	HA	▲
DPT.4.15.00.03.05	1,5	5	3	40	4	HA	▲
DPT.4.02.00.03.07	2,0	7	3	40	4	HA	▲
DPT.4.25.00.03.07	2,5	7	3	40	4	HA	▲
DPT.4.03.00.03.10	3,0	10	3	40	4	HA	▲
DPT.4.35.00.04.12	3,5	12	4	50	4	HA	▲
DPT.4.04.00.04.15	4,0	15	4	50	4	HA	▲
DPT.4.45.00.05.15	4,5	15	5	50	4	HA	▲
DPT.4.05.00.05.15	5,0	15	5	50	4	HA	▲
DPT.4.06.00.06.20	6,0	20	6	65	4	HB	▲
DPT.4.07.00.08.20	7,0	20	8	65	4	HB	▲
DPT.4.08.00.08.20	8,0	20	8	65	4	HB	▲
DPT.4.09.00.10.22	9,0	22	10	70	4	HB	▲
DPT.4.10.00.10.22	10,0	22	10	70	4	HB	▲
DPT.4.11.00.11.25	11,0	25	11	70	4	HA	▲
DPT.4.12.00.12.25	12,0	25	12	80	4	HB	▲
DPT.4.14.00.14.30	14,0	30	14	90	4	HA	▲
DPT.4.16.00.16.32	16,0	32	16	90	4	HB	▲

▲ ab Lager / on stock Δ 4 Wochen / 4 weeks x auf Anfrage / upon request

● empfohlen / recommended

o bedingt einsetzbar / alternative recommendation

- nicht geeignet / not suitable

■ unbeschichtete HM-Sorten / uncoated grades

■ beschichtete HM-Sorten / coated grades

■ bestückt/Cermet / brazed/Cermet

Abmessungen in mm

Dimensions in mm

P	●
M	○
K	○
N	○
S	○
H	-

HM-Sorten  
Carbide grades







# Schnittdaten DPT Ø 1 - 16 mm

## Cutting Data DPT Ø 1 - 16 mm

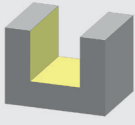
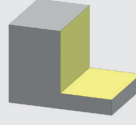

A

	 $v_c = \text{m/min}$	 $v_c = \text{m/min}$
P1.1	130	160
P1.2	120	140
P1.3	120	140
P2.1	110	130
P2.2	110	130
P2.3	110	130
P3.1	100	120
P3.2	100	120

$d_1$							
		$f_z$	$a_e$	$a_p$	$f_z$	$a_e$	$a_p$
1,0	4°	0,006	1	1	0,010	0,25	2,00
1,5	4°	0,007	2	2	0,013	0,38	3,00
2,0	4°	0,009	2	2	0,016	0,50	4,00
2,5	4°	0,011	3	3	0,019	0,63	5,00
3,0	4°	0,012	3	3	0,022	0,75	6,00
3,5	4°	0,014	4	4	0,024	0,88	7,00
4,0	4°	0,016	4	4	0,027	1,00	8,00
4,5	4°	0,017	5	5	0,030	1,13	9,00
5,0	4°	0,019	5	5	0,033	1,25	10,00
6,0	4°	0,022	6	6	0,038	1,50	12,00
7,0	4°	0,026	7	7	0,044	1,75	14,00
8,0	4°	0,029	8	8	0,049	2,00	16,00
9,0	4°	0,032	9	9	0,055	2,25	18,00
10,0	4°	0,036	10	10	0,060	2,50	20,00
11,0	4°	0,039	11	11	0,066	2,75	22,00
12,0	4°	0,042	12	12	0,072	3,00	24,00
14,0	4°	0,049	14	14	0,083	3,50	28,00
16,0	4°	0,056	16	16	0,094	4,00	32,00

Abmessungen in mm  
Dimensions in mm

### DPTR

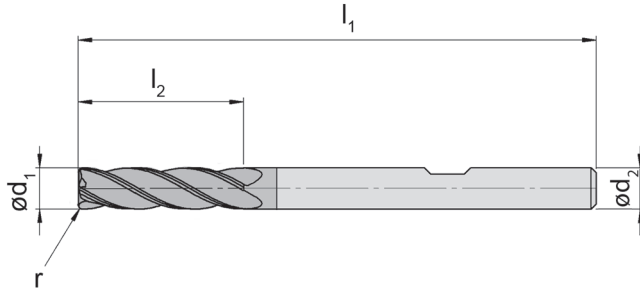
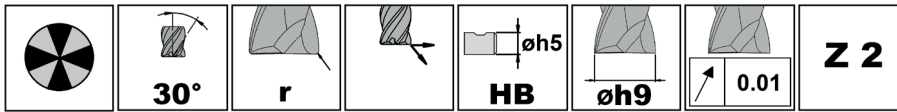

Bestellnummer Part number	d <sub>1</sub>	r	l <sub>2</sub>	d <sub>2</sub>	l <sub>1</sub>	Z	Ausführung Version	TF2K
DPTR.2.03.03.06.12	3	0,3	12	6	50	2	HB	▲
DPTR.2.04.03.06.15	4	0,3	15	6	50	2	HB	▲
DPTR.2.04.05.06.15	4	0,5	15	6	50	2	HB	▲
DPTR.2.05.03.06.20	5	0,3	20	6	60	2	HB	▲
DPTR.2.05.05.06.20	5	0,5	20	6	60	2	HB	▲
DPTR.2.06.03.06.20	6	0,3	20	6	60	2	HB	▲
DPTR.2.06.05.06.20	6	0,5	20	6	60	2	HB	▲
DPTR.2.06.10.06.20	6	1,0	20	6	60	2	HB	▲
DPTR.2.08.03.08.25	8	0,3	25	8	70	2	HB	▲
DPTR.2.08.05.08.25	8	0,5	25	8	70	2	HB	▲
DPTR.2.08.10.08.25	8	1,0	25	8	70	2	HB	▲
DPTR.2.08.15.08.25	8	1,5	25	8	70	2	HB	▲
DPTR.2.08.20.08.25	8	2,0	25	8	70	2	HB	▲
DPTR.2.10.03.10.30	10	0,3	30	10	90	2	HB	▲
DPTR.2.10.05.10.30	10	0,5	30	10	90	2	HB	▲
DPTR.2.10.10.10.30	10	1,0	30	10	90	2	HB	▲
DPTR.2.10.15.10.30	10	1,5	30	10	90	2	HB	▲
DPTR.2.10.20.10.30	10	2,0	30	10	90	2	HB	▲
DPTR.2.12.05.12.30	12	0,5	30	12	90	2	HB	▲
DPTR.2.12.10.12.30	12	1,0	30	12	90	2	HB	▲
DPTR.2.12.20.12.30	12	2,0	30	12	90	2	HB	▲
DPTR.2.16.05.16.50	16	0,5	50	16	110	2	HB	▲
DPTR.2.16.10.16.50	16	1,0	50	16	110	2	HB	▲
DPTR.2.16.15.16.50	16	1,5	50	16	110	2	HB	▲
DPTR.2.16.20.16.50	16	2,0	50	16	110	2	HB	▲
DPTR.2.20.05.20.50	20	0,5	50	20	110	2	HB	▲
DPTR.2.20.10.20.50	20	1,0	50	20	110	2	HB	▲
DPTR.2.20.15.20.50	20	1,5	50	20	110	2	HB	▲
DPTR.2.20.20.20.50	20	2,0	50	20	110	2	HB	▲

▲ ab Lager / on stock Δ 4 Wochen / 4 weeks x auf Anfrage / upon request

● empfohlen / recommended

○ bedingt einsetzbar / alternative recommendation

- nicht geeignet / not suitable

■ unbeschichtete HM-Sorten / uncoated grades

■ beschichtete HM-Sorten / coated grades

■ bestückt/Cermet / brazed/Cermet

Abmessungen in mm

Dimensions in mm

P	●
M	○
K	○
N	○
S	○
H	-

HM-Sorten  
Carbide grades



# Schnittdaten DPTR Ø 3 - 20 mm

## Cutting Data DPTR Ø 3 - 20 mm

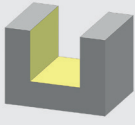
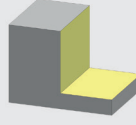

A

	 $v_c = \text{m/min}$	 $v_c = \text{m/min}$
P1.1	130	160
P1.2	120	140
P1.3	120	140
P2.1	110	130
P2.2	110	130
P2.3	110	130
P3.1	100	120
P3.2	100	120

$d_1$							
		$f_z$	$a_e$	$a_p$	$f_z$	$a_e$	$a_p$
3	5°	0,019	3	3	0,036	0,75	6,00
4	5°	0,023	4	4	0,041	1,00	8,00
4	5°	0,023	4	4	0,041	1,00	8,00
5	5°	0,026	5	5	0,047	1,25	10,00
5	5°	0,026	5	5	0,047	1,25	10,00
6	5°	0,029	6	6	0,052	1,50	12,00
6	5°	0,029	6	6	0,052	1,50	12,00
6	5°	0,029	6	6	0,052	1,50	12,00
8	5°	0,036	8	8	0,063	2,00	16,00
8	5°	0,036	8	8	0,063	2,00	16,00
8	5°	0,036	8	8	0,063	2,00	16,00
8	5°	0,036	8	8	0,063	2,00	16,00
8	5°	0,036	8	8	0,063	2,00	16,00
10	5°	0,043	10	10	0,074	2,50	20,00
10	5°	0,043	10	10	0,074	2,50	20,00
10	5°	0,043	10	10	0,074	2,50	20,00
10	5°	0,043	10	10	0,074	2,50	20,00
10	5°	0,043	10	10	0,074	2,50	20,00
12	5°	0,049	12	12	0,086	3,00	24,00
12	5°	0,049	12	12	0,086	3,00	24,00
12	5°	0,049	12	12	0,086	3,00	24,00
16	5°	0,063	16	16	0,108	4,00	32,00
16	5°	0,063	16	16	0,108	4,00	32,00
16	5°	0,063	16	16	0,108	4,00	32,00
16	5°	0,063	16	16	0,108	4,00	32,00
20	5°	0,076	20	20	0,130	5,00	40,00
20	5°	0,076	20	20	0,130	5,00	40,00
20	5°	0,076	20	20	0,130	5,00	40,00
20	5°	0,076	20	20	0,130	5,00	40,00

Abmessungen in mm  
Dimensions in mm

### DPTR

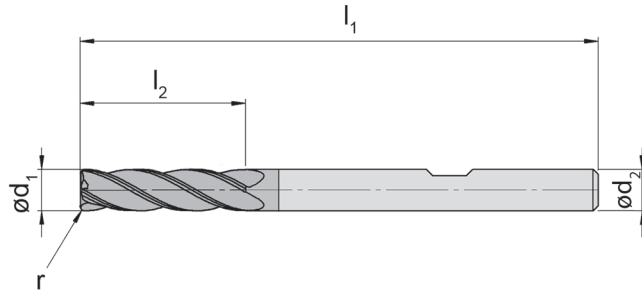
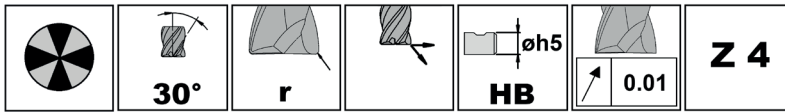

Bestellnummer Part number	d <sub>1</sub>	r	l <sub>2</sub>	d <sub>2</sub>	l <sub>1</sub>	Z	Ausführung Version	TF2K
DPTR.4.03.03.06.12	3	0,3	12	6	50	4	HB	▲
DPTR.4.04.03.06.15	4	0,3	15	6	50	4	HB	▲
DPTR.4.04.05.06.15	4	0,5	15	6	50	4	HB	▲
DPTR.4.05.03.06.20	5	0,3	20	6	60	4	HB	▲
DPTR.4.05.05.06.20	5	0,5	20	6	60	4	HB	▲
DPTR.4.06.03.06.20	6	0,3	20	6	60	4	HB	▲
DPTR.4.06.05.06.20	6	0,5	20	6	60	4	HB	▲
DPTR.4.06.10.06.20	6	1,0	20	6	60	4	HB	▲
DPTR.4.08.03.08.25	8	0,3	25	8	70	4	HB	▲
DPTR.4.08.05.08.25	8	0,5	25	8	70	4	HB	▲
DPTR.4.08.10.08.25	8	1,0	25	8	70	4	HB	▲
DPTR.4.08.15.08.25	8	1,5	25	8	70	4	HB	▲
DPTR.4.08.20.08.25	8	2,0	25	8	70	4	HB	▲
DPTR.4.10.03.10.30	10	0,3	30	10	90	4	HB	▲
DPTR.4.10.05.10.30	10	0,5	30	10	90	4	HB	▲
DPTR.4.10.10.10.30	10	1,0	30	10	90	4	HB	▲
DPTR.4.10.15.10.30	10	1,5	30	10	90	4	HB	▲
DPTR.4.10.20.10.30	10	2,0	30	10	90	4	HB	▲
DPTR.4.12.05.12.30	12	0,5	30	12	90	4	HB	▲
DPTR.4.12.10.12.30	12	1,0	30	12	90	4	HB	▲
DPTR.4.12.15.12.30	12	1,5	30	12	90	4	HB	▲
DPTR.4.12.20.12.30	12	2,0	30	12	90	4	HB	▲
DPTR.4.16.05.16.50	16	0,5	50	16	110	4	HB	▲
DPTR.4.16.10.16.50	16	1,0	50	16	110	4	HB	▲
DPTR.4.16.15.16.50	16	1,5	50	16	110	4	HB	▲
DPTR.4.16.20.16.50	16	2,0	50	16	110	4	HB	▲
DPTR.4.20.05.20.50	20	0,5	50	20	110	4	HB	▲
DPTR.4.20.10.20.50	20	1,0	50	20	110	4	HB	▲
DPTR.4.20.15.20.50	20	1,5	50	20	110	4	HB	▲
DPTR.4.20.20.20.50	20	2,0	50	20	110	4	HB	▲

▲ ab Lager / on stock Δ 4 Wochen / 4 weeks x auf Anfrage / upon request

● empfohlen / recommended

○ bedingt einsetzbar / alternative recommendation

- nicht geeignet / not suitable

■ unbeschichtete HM-Sorten / uncoated grades

■ beschichtete HM-Sorten / coated grades

■ bestückt/Cermet / brazed/Cermet

Abmessungen in mm

Dimensions in mm

P	●
M	○
K	○
N	○
S	○
H	-

HM-Sorten  
Carbide grades



# Schnittdaten DPTR Ø 3 - 20 mm

## Cutting Data DPTR Ø 3 - 20 mm

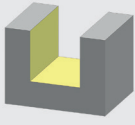
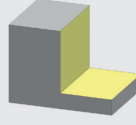

A

	 $v_c = \text{m/min}$	 $v_c = \text{m/min}$
P1.1	130	160
P1.2	120	140
P1.3	120	140
P2.1	110	130
P2.2	110	130
P2.3	110	130
P3.1	100	120
P3.2	100	120

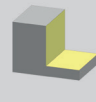
$d_1$							
		$f_z$	$a_e$	$a_p$	$f_z$	$a_e$	$a_p$
3	4°	0,012	3	3	0,022	0,75	6,00
4	4°	0,016	4	4	0,027	1,00	8,00
4	4°	0,016	4	4	0,027	1,00	8,00
5	4°	0,019	5	5	0,033	1,25	10,00
5	4°	0,019	5	5	0,033	1,25	10,00
6	4°	0,022	6	6	0,038	1,50	12,00
6	4°	0,022	6	6	0,038	1,50	12,00
6	4°	0,022	6	6	0,038	1,50	12,00
8	4°	0,029	8	8	0,049	2,00	16,00
8	4°	0,029	8	8	0,049	2,00	16,00
8	4°	0,029	8	8	0,049	2,00	16,00
8	4°	0,029	8	8	0,049	2,00	16,00
8	4°	0,029	8	8	0,049	2,00	16,00
10	4°	0,036	10	10	0,060	2,50	20,00
10	4°	0,036	10	10	0,060	2,50	20,00
10	4°	0,036	10	10	0,060	2,50	20,00
10	4°	0,036	10	10	0,060	2,50	20,00
10	4°	0,036	10	10	0,060	2,50	20,00
12	4°	0,042	12	12	0,072	3,00	24,00
12	4°	0,042	12	12	0,072	3,00	24,00
12	4°	0,042	12	12	0,072	3,00	24,00
12	4°	0,042	12	12	0,072	3,00	24,00
16	4°	0,056	16	16	0,094	4,00	32,00
16	4°	0,056	16	16	0,094	4,00	32,00
16	4°	0,056	16	16	0,094	4,00	32,00
16	4°	0,056	16	16	0,094	4,00	32,00
20	4°	0,069	20	20	0,116	5,00	40,00
20	4°	0,069	20	20	0,116	5,00	40,00
20	4°	0,069	20	20	0,116	5,00	40,00
20	4°	0,069	20	20	0,116	5,00	40,00

Abmessungen in mm  
Dimensions in mm

# A Schafffräser Mehrschneider

## End Mill multiple fluted



### DPM

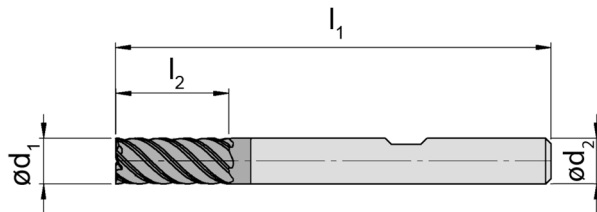
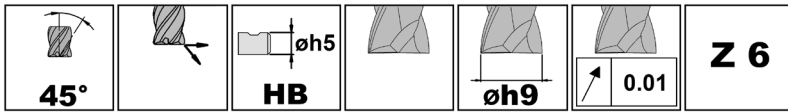

Bestellnummer Part number	d <sub>1</sub>	l <sub>2</sub>	d <sub>2</sub>	l <sub>1</sub>	Z	Ausführung Version	TF2K
DPM.6.06.00.06.13	6	13	6	58	6	HB	▲
DPM.6.08.00.08.19	8	19	8	65	6	HB	▲
DPM.6.10.00.10.22	10	22	10	72	6	HB	▲
DPM.6.12.00.12.26	12	26	12	83	6	HB	▲
DPM.6.16.00.16.32	16	32	16	92	6	HB	▲
DPM.8.20.00.20.38	20	38	20	103	8	HB	▲

▲ ab Lager / on stock Δ 4 Wochen / 4 weeks x auf Anfrage / upon request

● empfohlen / recommended

o bedingt einsetzbar / alternative recommendation

- nicht geeignet / not suitable

□ unbeschichtete HM-Sorten / uncoated grades

■ beschichtete HM-Sorten / coated grades

■ bestückt/Cermet / brazed/Cermet

Abmessungen in mm

Dimensions in mm

P	●
M	○
K	○
N	○
S	○
H	-

HM-Sorten  
Carbide grades



# Schnittdaten DPM Ø 6 - 20 mm

## Cutting Data DPM Ø 6 - 20 mm

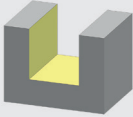
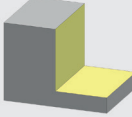

A

	 $v_c = \text{m/min}$	 $v_c = \text{m/min}$
<b>P1.1</b>	130	160
<b>P1.2</b>	120	140
<b>P1.3</b>	120	140
<b>P2.1</b>	110	130
<b>P2.2</b>	110	130
<b>P2.3</b>	110	130
<b>P3.1</b>	100	120
<b>P3.2</b>	100	120

$d_1$							
		$f_z$	$a_e$	$a_p$	$f_z$	$a_e$	$a_p$
6	3°	0,010	0,60	12,00	0,018	0,06	12,00
8	3°	0,015	0,80	16,00	0,035	0,08	16,00
10	3°	0,021	1,00	20,00	0,053	0,10	20,00
12	3°	0,027	1,20	24,00	0,070	0,12	24,00
16	3°	0,038	1,60	32,00	0,104	0,16	32,00
20	3°	0,040	2,00	40,00	0,110	0,20	38,00

Abmessungen in mm  
Dimensions in mm



### DPK

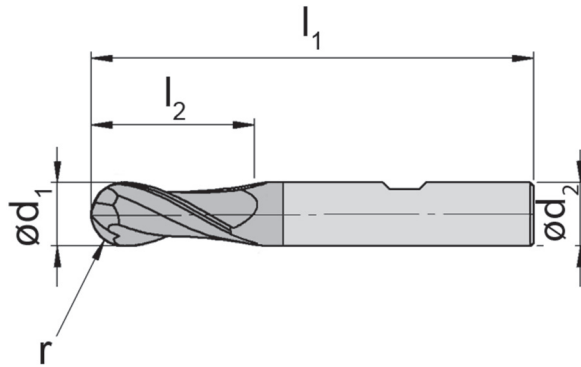
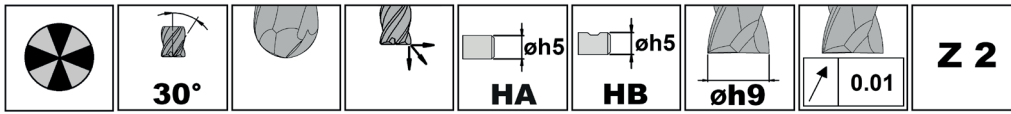

Bestellnummer Part number	d <sub>1</sub>	r	l <sub>2</sub>	d <sub>2</sub>	l <sub>1</sub>	Z	Ausführung Type	TF2K
DPK.2.010.03.03	1,0	0,50	3	3	40	2	HA	▲
DPK.2.015.03.05	1,5	0,75	5	3	40	2	HA	▲
DPK.2.020.03.07	2,0	1,00	7	3	40	2	HA	▲
DPK.2.025.03.07	2,5	1,25	7	3	40	2	HA	▲
DPK.2.030.03.10	3,0	1,50	10	3	40	2	HA	▲
DPK.2.035.04.12	3,5	1,75	12	4	50	2	HA	▲
DPK.2.040.04.15	4,0	2,00	15	4	50	2	HA	▲
DPK.2.045.05.15	4,5	2,25	15	5	50	2	HA	▲
DPK.2.050.05.15	5,0	2,50	15	5	50	2	HA	▲
DPK.2.060.06.20	6,0	3,00	20	6	65	2	HB	▲
DPK.2.080.08.20	8,0	4,00	20	8	65	2	HB	▲
DPK.2.100.10.22	10,0	5,00	22	10	70	2	HB	▲
DPK.2.120.12.25	12,0	6,00	25	12	80	2	HB	▲
DPK.2.160.16.32	16,0	8,00	32	16	90	2	HB	▲

▲ ab Lager / on stock Δ 4 Wochen / 4 weeks x auf Anfrage / upon request

● empfohlen / recommended

o bedingt einsetzbar / alternative recommendation

- nicht geeignet / not suitable

■ unbeschichtete HM-Sorten / uncoated grades

■ beschichtete HM-Sorten / coated grades

■ bestückt/Cermet / brazed/Cermet

Abmessungen in mm

Dimensions in mm

P	●
M	○
K	○
N	○
S	○
H	-

HM-Sorten  
Carbide grades



# Schnittdaten DPK Ø 1 - 16 mm

## Cutting Data DPK Ø 1 - 16 mm

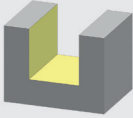
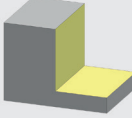

A

	 $v_c = \text{m/min}$	 $v_c = \text{m/min}$
P1.1	130	160
P1.2	120	140
P1.3	120	140
P2.1	110	130
P2.2	110	130
P2.3	110	130
P3.1	100	120
P3.2	100	120

$d_1$							
		$f_z$	$a_e$	$a_p$	$f_z$	$a_e$	$a_p$
1,0	5°	0,016	0,30	0,30	0,023	0,02	0,05
1,5	5°	0,019	0,45	0,45	0,027	0,02	0,08
2,0	5°	0,022	0,60	0,60	0,031	0,03	0,10
2,5	5°	0,025	0,75	0,75	0,034	0,04	0,13
3,0	5°	0,028	0,90	0,90	0,038	0,05	0,15
3,5	5°	0,031	1,05	1,05	0,042	0,05	0,18
4,0	5°	0,034	1,20	1,20	0,045	0,06	0,20
4,5	5°	0,037	1,35	1,35	0,049	0,07	0,23
5,0	5°	0,040	1,50	1,50	0,053	0,08	0,25
6,0	5°	0,046	1,80	1,80	0,060	0,09	0,30
8,0	5°	0,058	2,40	2,40	0,075	0,12	0,40
10,0	5°	0,070	3,00	3,00	0,090	0,15	0,50
12,0	5°	0,081	3,60	3,60	0,105	0,18	0,60
16,0	5°	0,105	4,80	4,80	0,134	0,24	0,80

Abmessungen in mm  
Dimensions in mm

### DPK

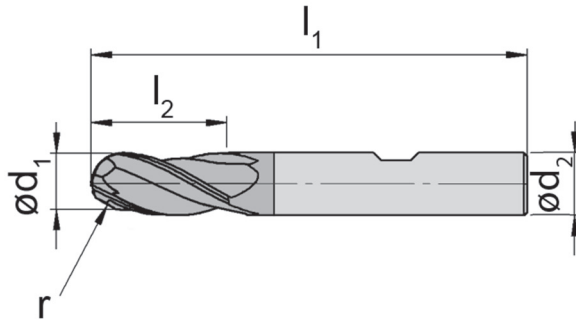
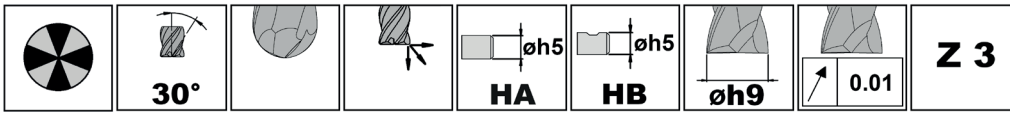

Bestellnummer Part number	d <sub>1</sub>	r	l <sub>2</sub>	d <sub>2</sub>	l <sub>1</sub>	Z	Ausführung Type	TF2K
DPK.3.015.03.05	1,5	0,75	5	3	40	3	HA	▲
DPK.3.020.03.07	2,0	1,00	7	3	40	3	HA	▲
DPK.3.025.03.07	2,5	1,25	7	3	40	3	HA	▲
DPK.3.030.03.10	3,0	1,50	10	3	40	3	HA	▲
DPK.3.035.04.12	3,5	1,75	12	4	50	3	HA	▲
DPK.3.040.04.15	4,0	2,00	15	4	50	3	HA	▲
DPK.3.045.05.15	4,5	2,25	15	5	50	3	HA	▲
DPK.3.050.05.15	5,0	2,50	15	5	50	3	HA	▲
DPK.3.060.06.20	6,0	3,00	20	6	65	3	HB	▲
DPK.3.080.08.20	8,0	4,00	20	8	65	3	HB	▲
DPK.3.100.10.22	10,0	5,00	22	10	70	3	HB	▲
DPK.3.120.12.25	12,0	6,00	25	12	80	3	HB	▲
DPK.3.140.14.30	14,0	7,00	30	14	90	3	HA	▲
DPK.3.160.16.32	16,0	8,00	32	16	90	3	HB	▲
DPK.3.200.20.38	20,0	10,00	38	20	100	3	HB	▲

▲ ab Lager / on stock   Δ 4 Wochen / 4 weeks   x auf Anfrage / upon request

● empfohlen / recommended

○ bedingt einsetzbar / alternative recommendation

- nicht geeignet / not suitable

□ unbeschichtete HM-Sorten / uncoated grades

■ beschichtete HM-Sorten / coated grades

■ bestückt/Cermet / brazed/Cermet

Abmessungen in mm

Dimensions in mm

P	●
M	○
K	○
N	○
S	○
H	-

HM-Sorten  
Carbide grades



# Schnittdaten DPK Ø 1,5 - 20 mm

## Cutting Data DPK Ø 1,5 - 20 mm

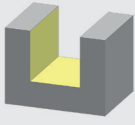
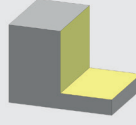

A

	 $v_c = \text{m/min}$	 $v_c = \text{m/min}$
<b>P1.1</b>	130	160
<b>P1.2</b>	120	140
<b>P1.3</b>	120	140
<b>P2.1</b>	110	130
<b>P2.2</b>	110	130
<b>P2.3</b>	110	130
<b>P3.1</b>	100	120
<b>P3.2</b>	100	120

$d_1$							
		$f_z$	$a_e$	$a_p$	$f_z$	$a_e$	$a_p$
1,5	5°	0,010	0,45	0,45	0,016	0,02	0,08
2,0	5°	0,013	0,60	0,60	0,020	0,03	0,10
2,5	5°	0,016	0,75	0,75	0,024	0,04	0,13
3,0	5°	0,019	0,90	0,90	0,027	0,05	0,15
3,5	5°	0,022	1,05	1,05	0,031	0,05	0,18
4,0	5°	0,024	1,20	1,20	0,035	0,06	0,20
4,5	5°	0,027	1,35	1,35	0,038	0,07	0,23
5,0	5°	0,030	1,50	1,50	0,042	0,08	0,25
6,0	5°	0,036	1,80	1,80	0,050	0,09	0,30
8,0	5°	0,048	2,40	2,40	0,064	0,12	0,40
10,0	5°	0,060	3,00	3,00	0,079	0,15	0,50
12,0	5°	0,072	3,60	3,60	0,094	0,18	0,60
14,0	5°	0,084	4,20	4,20	0,109	0,21	0,70
16,0	5°	0,095	4,80	4,80	0,124	0,24	0,80
20,0	5°	0,119	6,00	6,00	0,153	0,30	1,00

Abmessungen in mm  
Dimensions in mm

### DPK

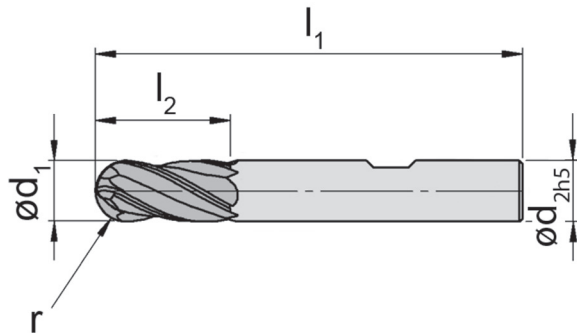
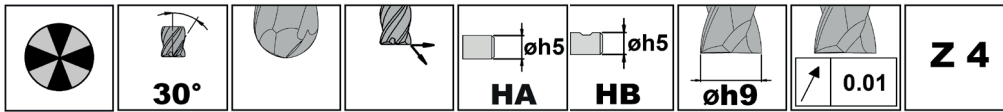

Bestellnummer Part number	d <sub>1</sub>	r	l <sub>2</sub>	d <sub>2</sub>	l <sub>1</sub>	Z	Ausführung Version	TF2K
DPK.4.010.03.03	1,0	0,50	3	3	40	4	HA	▲
DPK.4.015.03.05	1,5	0,75	5	3	40	4	HA	▲
DPK.4.020.03.07	2,0	1,00	7	3	40	4	HA	▲
DPK.4.025.03.07	2,5	1,25	7	3	40	4	HA	▲
DPK.4.030.03.10	3,0	1,50	10	3	40	4	HA	▲
DPK.4.035.04.12	3,5	1,75	12	4	50	4	HA	▲
DPK.4.040.04.15	4,0	2,00	15	4	50	4	HA	▲
DPK.4.050.05.15	5,0	2,50	15	5	50	4	HA	▲
DPK.4.060.06.20	6,0	3,00	20	6	65	4	HB	▲
DPK.4.080.08.20	8,0	4,00	20	8	65	4	HB	▲
DPK.4.100.10.22	10,0	5,00	22	10	70	4	HB	▲
DPK.4.120.12.25	12,0	6,00	25	12	80	4	HB	▲
DPK.4.160.16.32	16,0	8,00	32	16	90	4	HB	▲
DPK.4.200.20.38	20,0	10,00	38	20	100	4	HB	▲

▲ ab Lager / on stock Δ 4 Wochen / 4 weeks x auf Anfrage / upon request

● empfohlen / recommended

o bedingt einsetzbar / alternative recommendation

- nicht geeignet / not suitable

■ unbeschichtete HM-Sorten / uncoated grades

■ beschichtete HM-Sorten / coated grades

■ bestückt/Cermet / brazed/Cermet

Abmessungen in mm

Dimensions in mm

P	●
M	○
K	○
N	○
S	○
H	-

HM-Sorten  
Carbide grades



# Schnittdaten DPK Ø 1 - 20 mm

## Cutting Data DPK Ø 1 - 20 mm

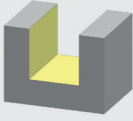
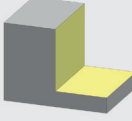

A

	 $v_c = \text{m/min}$	 $v_c = \text{m/min}$
P1.1	130	160
P1.2	120	140
P1.3	120	140
P2.1	110	130
P2.2	110	130
P2.3	110	130
P3.1	100	120
P3.2	100	120

$d_1$							
		$f_z$	$a_e$	$a_p$	$f_z$	$a_e$	$a_p$
1,0	4°	0,002	0,30	0,30	0,007	0,02	0,05
1,5	4°	0,005	0,45	0,45	0,011	0,02	0,08
2,0	4°	0,008	0,60	0,60	0,015	0,03	0,10
2,5	4°	0,011	0,75	0,75	0,018	0,04	0,13
3,0	4°	0,014	0,90	0,90	0,022	0,05	0,15
3,5	4°	0,017	1,05	1,05	0,026	0,05	0,18
4,0	4°	0,020	1,20	1,20	0,029	0,06	0,20
5,0	4°	0,026	1,50	1,50	0,037	0,08	0,25
6,0	4°	0,032	1,80	1,80	0,044	0,09	0,30
8,0	4°	0,043	2,40	2,40	0,059	0,12	0,40
10,0	4°	0,055	3,00	3,00	0,074	0,15	0,50
12,0	4°	0,067	3,60	3,60	0,089	0,18	0,60
16,0	4°	0,091	4,80	4,80	0,118	0,24	0,80
20,0	4°	0,114	6,00	6,00	0,148	0,30	1,00

Abmessungen in mm  
Dimensions in mm

# DPFF

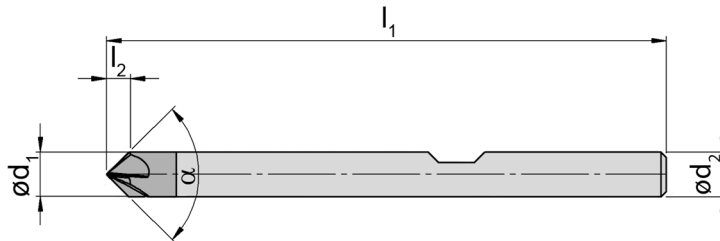
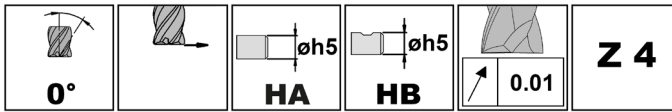

Bestellnummer Part number	d <sub>1</sub>	α	l <sub>2</sub>	l <sub>3</sub>	d <sub>2</sub>	l <sub>1</sub>	Z	Ausführung Type	TF2K
DPFF.4.04.035.060	4	60°	3,5	3,5	4	51	4	HA	▲
DPFF.4.06.052.060	6		5,2	5,2	6	64	4	HB	▲
DPFF.4.08.069.060	8		6,9	6,9	8	64	4	HB	▲
DPFF.4.10.087.060	10		8,7	8,7	10	70	4	HB	▲
DPFF.4.12.104.060	12		10,4	10,4	12	78	4	HB	▲
DPFF.4.04.020.090	4	90°	2,0	2,0	4	51	4	HA	▲
DPFF.4.06.030.090	6		3,0	3,0	6	64	4	HB	▲
DPFF.4.08.040.090	8		4,0	4,0	8	64	4	HB	▲
DPFF.4.10.050.090	10		5,0	5,0	10	70	4	HB	▲
DPFF.4.12.060.090	12		6,0	6,0	12	78	4	HB	▲
DPFF.4.04.011.120	4	120°	1,1	1,1	4	51	4	HA	▲
DPFF.4.06.017.120	6		1,7	1,7	6	64	4	HB	▲
DPFF.4.08.023.120	8		2,3	2,3	8	64	4	HB	▲
DPFF.4.10.028.120	10		2,8	2,8	10	70	4	HB	▲
DPFF.4.12.034.120	12		3,4	3,4	12	78	4	HB	▲

▲ ab Lager / on stock Δ 4 Wochen / 4 weeks x auf Anfrage / upon request

● empfohlen / recommended

o bedingt einsetzbar / alternative recommendation

- nicht geeignet / not suitable

■ unbeschichtete HM-Sorten / uncoated grades

■ beschichtete HM-Sorten / coated grades

■ bestückt/Cermet / brazed/Cermet

Abmessungen in mm

Dimensions in mm

P	●
M	○
K	○
N	○
S	○
H	-

HM-Sorten  
Carbide grades





# Schnittdaten DPFF Ø 4 - 12 mm

## Cutting Data DPFF Ø 4 - 12 mm

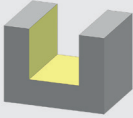
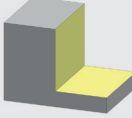

A

	 $v_c = \text{m/min}$	 $v_c = \text{m/min}$
P1.1	130	160
P1.2	120	140
P1.3	120	140
P2.1	110	130
P2.2	110	130
P2.3	110	130
P3.1	100	120
P3.2	100	120

$d_1$						
	$f_z$	$a_e$	$a_p$	$f_z$	$a_e$	$a_p$
4	0,021	1,00	1,00	0,038	0,10	0,10
6	0,026	1,50	1,50	0,062	0,09	0,30
8	0,031	2,00	2,00	0,059	0,20	0,20
10	0,036	2,50	2,50	0,089	0,15	0,50
12	0,041	3,00	3,00	0,080	0,30	0,30
4	0,021	1,00	1,00	0,049	0,06	0,20
6	0,026	1,50	1,50	0,048	0,15	0,15
8	0,031	2,00	2,00	0,076	0,12	0,40
10	0,036	2,50	2,50	0,069	0,25	0,25
12	0,041	3,00	3,00	0,103	0,18	0,60
4	0,021	1,00	1,00	0,038	0,10	0,10
6	0,026	1,50	1,50	0,062	0,09	0,30
8	0,031	2,00	2,00	0,059	0,20	0,20
10	0,036	2,50	2,50	0,089	0,15	0,50
12	0,041	3,00	3,00	0,080	0,30	0,30

Abmessungen in mm  
Dimensions in mm





Abgestimmt für:/designed for:

Seite/page

**hochfeste Stähle**  
high tensile steels

**B2-B71**

**gehärtete Stähle**  
hardened steels

**B72-B115**

**Kobalt-Chrom-Stähle**  
Cobalt chromium steels

**B116-B125**

**Titan**  
Titanium

**B126-B151**

**Aluminium / Kunststoffe**  
Aluminum / Synthetics





**B152-B187**

# Vollhartmetall-Schaftfräser

Solid Carbide End Mills



B

	DSKM	Schaftfräser Vollradius Mikro Ball Nose End Mill Micro	Ø 0,1 – Ø 3	Z 2	B4 – B7
	DSTM.2	Torusfräser Mikro Torus End Mill Micro	Ø 0,1 – Ø 3	Z 2	B8 – B17
	DSTM.4	Torusfräser Mikro Torus End Mill Micro	Ø 0,2 – Ø 3	Z 4	B18 – B27
	DSK	Schaftfräser Vollradius Ball Nose End Mill	Ø 3,5 – Ø 16	Z 2	B28 – B29
	DST.2	Torusfräser Torus End Mill	Ø 3,5 – Ø 16	Z 2	B30 – B37
	DST.4	Torusfräser Torus End Mill	Ø 3,5 – Ø 16	Z 4	B38 – B45
	DSM	Schaftfräser Mehrschneider End Mill multiple fluted	Ø 2 – Ø 20	Z 6-8	B46 – B49
	DSMR	Schaftfräser Mehrschneider, Eckenradius End Mill multiple fluted, corner radius	Ø 2 – Ø 20	Z 6-8	B50– B57
	DSR.3	Schrupfräser, Eckradius Roughing End Mill, corner radius	Ø 2 – Ø 16	Z 3	B58 – B59
	DSF.3	Schrupfräser, Eckfase Roughing End Mill, corner bevel	Ø 2 – Ø 16	Z 3	B60 – B61
	DSF.4	Schrupfräser, Eckfase Roughing End Mill, corner bevel	Ø 4 – Ø 16	Z 4	B62 – B63
	DSFT	Schaftfräser Trochoidalfräsen End Mill Trochoidal Milling	Ø 2 – Ø 20	Z 4-7	B64 – B67
	DSH	Hochvorschubfräser High Feed End Mill	Ø 2 – Ø 16	Z 4	B68 – B69
	DSFF	Fasfräser 90° Chamfering End Mill 90°	Ø 4 – Ø 12,0	Z 4	B70 – B71

**DS**

**B**



**abgestimmt für:**

**- hochfeste Stähle**

**designed for:**

**- high tensile steels**

# Schaftfräser Vollradius Mikro

Ball Nose End Mill Micro



## DSKM

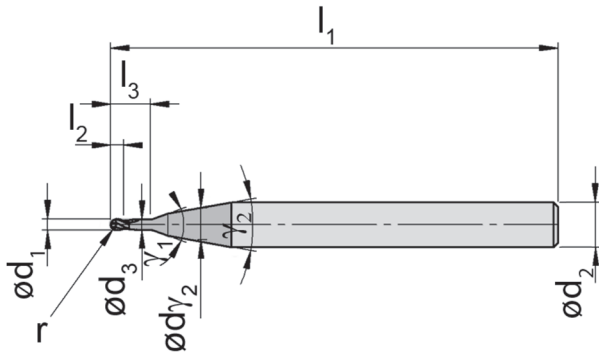
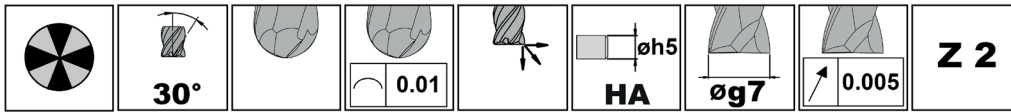

Bis Ø 3 mm vormontiert lieferbar für Toodle Schnelllaufspindel (siehe Seite D2)  
Pre-assembled available up to Ø 3 mm for Toodle high-speed spindle (see page D2)

Bestellnummer Part number	d <sub>1</sub>	r	l <sub>2</sub>	l <sub>3</sub>	d <sub>3</sub>	d <sub>2</sub>	l <sub>1</sub>	Z	γ <sub>1</sub>	γ <sub>2</sub>	TS3K
DSKM.2.010.030	0,1	0,05	0,2	0,3	0,08	4	50	2	20°	-	▲
DSKM.2.010.050	0,1	0,05	0,2	0,5	0,08	4	50	2	40°	20°	▲
DSKM.2.010.070	0,1	0,05	0,2	0,7	0,08	4	50	2	40°	20°	▲
DSKM.2.020.030	0,2	0,10	0,4	0,6	0,18	4	50	2	20°	-	▲
DSKM.2.020.050	0,2	0,10	0,4	1,0	0,18	4	50	2	40°	20°	▲
DSKM.2.020.070	0,2	0,10	0,4	1,4	0,18	4	50	2	40°	20°	▲
DSKM.2.030.030	0,3	0,15	0,6	0,9	0,28	4	50	2	20°	-	▲
DSKM.2.030.050	0,3	0,15	0,6	1,5	0,28	4	50	2	40°	20°	▲
DSKM.2.030.070	0,3	0,15	0,6	2,1	0,28	4	50	2	40°	20°	▲
DSKM.2.040.030	0,4	0,20	0,8	1,2	0,35	4	50	2	20°	-	▲
DSKM.2.040.050	0,4	0,20	0,8	2,0	0,35	4	50	2	40°	20°	▲
DSKM.2.040.070	0,4	0,20	0,8	2,8	0,35	4	50	2	40°	20°	▲
DSKM.2.050.030	0,5	0,25	1,0	1,5	0,47	4	50	2	20°	-	▲
DSKM.2.050.050	0,5	0,25	1,0	2,5	0,47	4	50	2	40°	20°	▲
DSKM.2.050.070	0,5	0,25	1,0	3,5	0,47	4	50	2	40°	20°	▲
DSKM.2.060.030	0,6	0,30	1,2	1,8	0,55	4	50	2	20°	-	▲
DSKM.2.060.050	0,6	0,30	1,2	3,0	0,55	4	50	2	40°	20°	▲
DSKM.2.060.070	0,6	0,30	1,2	4,2	0,55	4	50	2	40°	20°	▲
DSKM.2.070.030	0,7	0,35	1,4	2,1	0,65	4	50	2	20°	-	▲
DSKM.2.070.050	0,7	0,35	1,4	3,5	0,65	4	50	2	40°	20°	▲
DSKM.2.070.070	0,7	0,35	1,4	4,9	0,65	4	50	2	40°	20°	▲
DSKM.2.080.030	0,8	0,40	1,6	2,4	0,75	4	50	2	20°	-	▲
DSKM.2.080.050	0,8	0,40	1,6	4,0	0,75	4	50	2	40°	20°	▲
DSKM.2.080.070	0,8	0,40	1,6	5,6	0,75	4	50	2	40°	20°	▲

▲ ab Lager / on stock Δ 4 Wochen / 4 weeks x auf Anfrage / upon request

● empfohlen / recommended

o bedingt einsetzbar / alternative recommendation

- nicht geeignet / not suitable

■ unbeschichtete HM-Sorten / uncoated grades

■ beschichtete HM-Sorten / coated grades

■ bestückt/Cermet / brazed/Cermet

Abmessungen in mm

Dimensions in mm



P	●
M	○
K	○
N	-
S	○
H	○



HM-Sorten  
Carbide grades

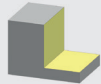

# Schnittdaten DSKM Ø 0,1 - 0,8 mm

## Cutting Data DSKM Ø 0,1 - 0,8 mm

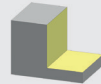

	 $vc = m/min$	 $vc = m/min$
P1.1	160	190
P1.2	160	190
P1.3	150	180
P2.1	140	170
P2.2	140	170
P2.3	140	170
P3.1	120	140
P3.2	110	130
M1.1	90	110
M2.1	80	100
M3.1	60	70

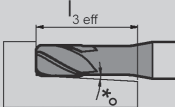
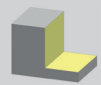
	 $vc = m/min$	 $vc = m/min$
K1.1	140	170
K1.2	130	160
K2.1	120	140
K2.2	100	120
K3.1	80	100
K3.2	70	80
S1	70	80
S2	55	70
S3	40	50
-	-	-
-	-	-

$d_1$	 $\alpha$	 $l_{3\text{eff}}$					$f_z$	$a_e$	$a_p$	 $f_z$			 $a_e$		
		0°	0,5°	1°	2°	3°				$f_z$	$a_e$	$a_p$			
0,1	5°	0,3	0,3	0,3	0,3	0,4	0,004	0,01	0,02	0,005	0,01	0,01			
0,1	5°	0,5	0,5	0,5	0,5	0,5	0,003	0,01	0,02	0,005	0,01	0,01			
0,1	3°	0,7	0,7	0,7	0,7	0,8	0,003	0,01	0,01	0,004	0,01	0,01			
0,2	5°	0,6	0,6	0,6	0,7	0,8	0,004	0,02	0,04	0,006	0,01	0,02			
0,2	5°	1,0	1,0	1,0	1,1	1,1	0,004	0,02	0,03	0,005	0,01	0,02			
0,2	3°	1,4	1,4	1,4	1,5	1,6	0,003	0,02	0,02	0,005	0,01	0,01			
0,3	5°	0,9	0,9	0,9	1,0	1,2	0,005	0,03	0,06	0,007	0,02	0,03			
0,3	5°	1,5	1,5	1,5	1,6	1,7	0,004	0,03	0,05	0,006	0,02	0,02			
0,3	3°	2,1	2,1	2,2	2,3	2,4	0,004	0,03	0,03	0,006	0,02	0,02			
0,4	5°	1,2	1,2	1,2	1,3	1,5	0,006	0,04	0,08	0,008	0,02	0,04			
0,4	5°	2,0	2,0	2,0	2,1	2,2	0,005	0,04	0,06	0,007	0,02	0,03			
0,4	3°	2,8	2,8	2,9	3,0	3,1	0,004	0,04	0,04	0,006	0,02	0,02			
0,5	5°	1,5	1,5	1,6	1,8	2,0	0,006	0,05	0,10	0,009	0,03	0,05			
0,5	5°	2,5	2,5	2,6	2,7	2,8	0,006	0,05	0,08	0,008	0,03	0,04			
0,5	3°	3,5	3,5	3,6	3,8	4,0	0,005	0,05	0,05	0,007	0,03	0,03			
0,6	5°	1,8	1,8	1,9	2,1	2,4	0,007	0,06	0,12	0,010	0,03	0,06			
0,6	5°	3,0	3,0	3,1	3,2	3,4	0,006	0,06	0,09	0,009	0,03	0,05			
0,6	3°	4,2	4,3	4,4	4,6	4,8	0,005	0,06	0,06	0,008	0,03	0,04			
0,7	5°	2,1	2,1	2,2	2,4	2,7	0,007	0,07	0,14	0,010	0,04	0,07			
0,7	5°	3,5	3,5	3,6	3,7	3,9	0,007	0,07	0,11	0,009	0,04	0,06			
0,7	3°	4,9	5,0	5,1	5,3	5,5	0,006	0,07	0,07	0,008	0,04	0,04			
0,8	5°	2,4	2,5	2,6	2,9	3,2	0,008	0,08	0,16	0,011	0,04	0,08			
0,8	5°	4,0	4,0	4,1	4,3	4,6	0,007	0,08	0,12	0,010	0,04	0,06			
0,8	3°	5,6	5,7	5,8	6,1	6,4	0,006	0,08	0,08	0,009	0,04	0,05			

Abmessungen in mm  
Dimensions in mm

B



# Schaftfräser Vollradius Mikro

Ball Nose End Mill Micro



## DSKM

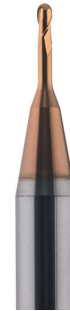
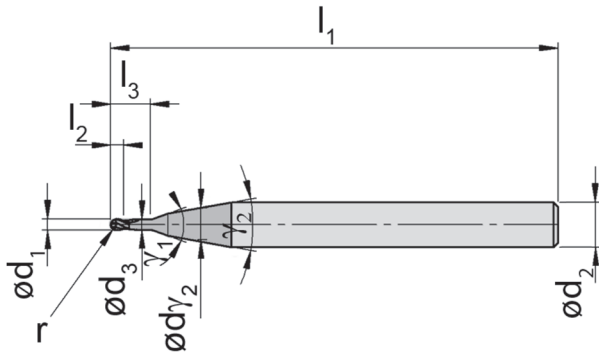
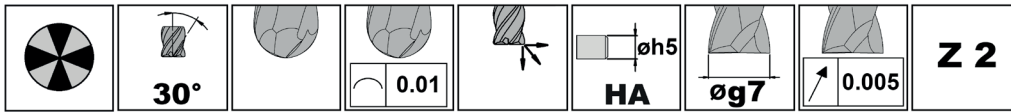

Bis Ø 3 mm vormontiert lieferbar für Toodle Schnelllaufspindel (siehe Seite D2)  
Pre-assembled available up to Ø 3 mm for Toodle high-speed spindle (see page D2)

Bestellnummer Part number	d <sub>1</sub>	r	l <sub>2</sub>	l <sub>3</sub>	d <sub>3</sub>	d <sub>2</sub>	l <sub>1</sub>	Z	γ <sub>1</sub>	γ <sub>2</sub>	TS3K
DSKM.2.090.030	0,9	0,45	1,8	2,7	0,85	4	50	2	20°	-	▲
DSKM.2.090.050	0,9	0,45	1,8	4,5	0,85	4	50	2	40°	20°	▲
DSKM.2.090.070	0,9	0,45	1,8	6,3	0,85	4	50	2	40°	20°	▲
DSKM.2.100.030	1,0	0,50	2,0	3,0	0,95	4	50	2	20°	-	▲
DSKM.2.100.050	1,0	0,50	2,0	5,0	0,95	4	50	2	40°	20°	▲
DSKM.2.100.070	1,0	0,50	2,0	7,0	0,95	4	50	2	40°	20°	▲
DSKM.2.120.030	1,2	0,60	2,4	3,6	1,15	4	50	2	20°	-	▲
DSKM.2.120.050	1,2	0,60	2,4	6,0	1,15	4	50	2	40°	20°	▲
DSKM.2.120.070	1,2	0,60	2,4	8,4	1,15	4	50	2	40°	20°	▲
DSKM.2.150.030	1,5	0,75	3,0	4,5	1,45	4	50	2	20°	-	▲
DSKM.2.150.050	1,5	0,75	3,0	7,5	1,45	4	50	2	40°	20°	▲
DSKM.2.150.070	1,5	0,75	3,0	10,5	1,45	4	50	2	40°	20°	▲
DSKM.2.200.030	2,0	1,00	4,0	6,0	1,90	4	50	2	20°	-	▲
DSKM.2.200.050	2,0	1,00	4,0	10,0	1,90	4	50	2	40°	20°	▲
DSKM.2.200.070	2,0	1,00	4,0	14,0	1,90	4	50	2	40°	20°	▲
DSKM.2.250.030	2,5	1,25	5,0	7,5	2,40	4	50	2	20°	-	▲
DSKM.2.250.050	2,5	1,25	5,0	12,5	2,40	4	50	2	40°	20°	▲
DSKM.2.250.070	2,5	1,25	5,0	17,5	2,40	4	60	2	40°	20°	▲
DSKM.2.300.030	3,0	1,50	6,0	9,0	2,90	4	50	2	20°	-	▲
DSKM.2.300.050	3,0	1,50	6,0	15,0	2,90	4	50	2	40°	20°	▲
DSKM.2.300.070	3,0	1,50	6,0	21,0	2,90	4	60	2	40°	20°	▲

- ▲ ab Lager / on stock   Δ 4 Wochen / 4 weeks   x auf Anfrage / upon request
- empfohlen / recommended
- o bedingt einsetzbar / alternative recommendation
- nicht geeignet / not suitable
- unbeschichtete HM-Sorten / uncoated grades
- beschichtete HM-Sorten / coated grades
- bestückt/Cermet / brazed/Cermet

P	●
M	○
K	○
N	-
S	○
H	○



Abmessungen in mm  
Dimensions in mm



HM-Sorten  
Carbide grades

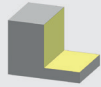

# Schnittdaten DSKM Ø 0,9 - 3 mm

## Cutting Data DSKM Ø 0,9 - 3 mm

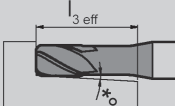

	 $vc = m/min$	 $vc = m/min$
P1.1	160	190
P1.2	160	190
P1.3	150	180
P2.1	140	170
P2.2	140	170
P2.3	140	170
P3.1	120	140
P3.2	110	130
M1.1	90	110
M2.1	80	100
M3.1	60	70

	 $vc = m/min$	 $vc = m/min$
K1.1	140	170
K1.2	130	160
K2.1	120	140
K2.2	100	120
K3.1	80	100
K3.2	70	80
S1	70	80
S2	55	70
S3	40	50
-	-	-
-	-	-

$d_1$	 $\alpha$	 $l_{3\text{eff}}$										
		0°	0,5°	1°	2°	3°	$f_z$	$a_e$	$a_p$	$f_z$	$a_e$	$a_p$
0,9	5°	2,7	2,8	2,9	3,2	3,5	0,009	0,09	0,18	0,012	0,05	0,09
0,9	5°	4,5	4,5	4,6	4,8	5,1	0,008	0,09	0,14	0,011	0,05	0,07
0,9	3°	6,3	6,4	6,5	6,8	7,1	0,007	0,09	0,09	0,010	0,05	0,05
1,0	5°	3,0	3,1	3,2	3,6	4	0,009	0,10	0,20	0,013	0,05	0,10
1,0	5°	5,0	5,1	5,2	5,4	5,7	0,008	0,10	0,15	0,012	0,05	0,08
1,0	3°	7,0	7	7,1	7,3	7,4	0,007	0,10	0,10	0,011	0,05	0,06
1,2	5°	3,6	3,7	3,9	4,3	4,8	0,011	0,12	0,24	0,015	0,06	0,12
1,2	5°	6,0	6,1	6,2	6,5	6,9	0,010	0,12	0,18	0,013	0,06	0,10
1,2	3°	8,4	8,5	8,7	9,2	9,8	0,008	0,12	0,12	0,012	0,06	0,07
1,5	5°	4,5	4,7	4,9	5,4	6,1	0,012	0,15	0,30	0,018	0,08	0,15
1,5	5°	7,5	7,6	7,8	8,2	8,6	0,011	0,15	0,23	0,016	0,08	0,12
1,5	3°	10,5	10,7	10,9	11,5	12,3	0,010	0,15	0,15	0,014	0,08	0,09
2,0	5°	6,0	6,2	6,5	7,2	8,1	0,016	0,20	0,40	0,022	0,10	0,20
2,0	5°	10,0	10,2	10,4	10,9	11,5	0,014	0,20	0,30	0,020	0,10	0,16
2,0	3°	14,0	14,3	14,6	15,3	17,2	0,013	0,20	0,20	0,018	0,10	0,12
2,5	5°	7,5	7,8	8,1	9	10,1	0,019	0,25	0,50	0,027	0,13	0,25
2,5	5°	12,5	12,7	13	13,7	∞	0,017	0,25	0,38	0,024	0,13	0,20
2,5	3°	17,5	17,9	18,3	19,5	∞	0,015	0,25	0,25	0,021	0,13	0,15
3,0	5°	9,0	9,3	9,8	10,8	∞	0,022	0,30	0,60	0,031	0,15	0,30
3,0	5°	15,0	15,3	15,6	∞	∞	0,020	0,30	0,45	0,028	0,15	0,24
3,0	3°	21,0	21,4	22,1	∞	∞	0,018	0,30	0,30	0,025	0,15	0,18

Abmessungen in mm  
Dimensions in mm

B

### DSTM

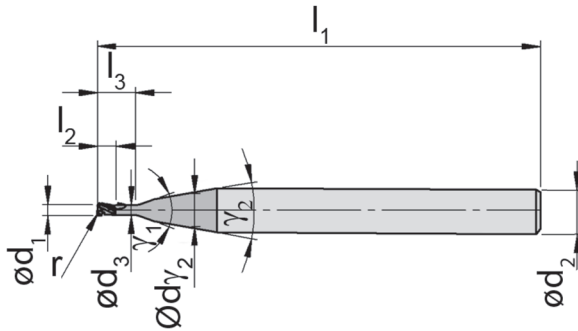
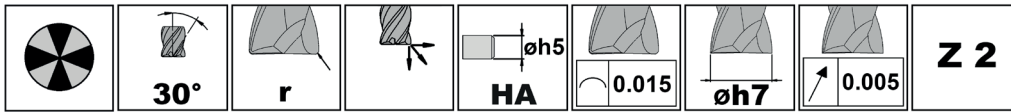

Bis Ø 3 mm vormontiert lieferbar für Toodle Schnelllaufspindel (siehe Seite D2)  
Pre-assembled available up to Ø 3 mm for Toodle high-speed spindle (see page D2)

Bestellnummer Part number	d <sub>1</sub>	r	l <sub>2</sub>	l <sub>3</sub>	d <sub>3</sub>	d <sub>2</sub>	l <sub>1</sub>	Z	γ <sub>1</sub>	γ <sub>2</sub>	d <sub>2</sub>	TS3K
DSTM.2.010.000.030	0,1	0	0,2	0,3	0,08	4	50	2	20°	-	-	▲
DSTM.2.010.000.050	0,1	0	0,2	0,5	0,08	4	50	2	40°	20°	1,5	▲
DSTM.2.010.000.070	0,1	0	0,2	0,7	0,08	4	50	2	40°	20°	1,5	▲
DSTM.2.020.000.030	0,2	0	0,4	0,6	0,18	4	50	2	20°	-	-	▲
DSTM.2.020.000.050	0,2	0	0,4	1,0	0,18	4	50	2	40°	20°	1,5	▲
DSTM.2.020.000.070	0,2	0	0,4	1,4	0,18	4	50	2	40°	20°	1,5	▲
DSTM.2.030.000.030	0,3	0	0,6	0,9	0,28	4	50	2	20°	-	-	▲
DSTM.2.030.000.050	0,3	0	0,6	1,5	0,28	4	50	2	40°	20°	1,5	▲
DSTM.2.030.000.070	0,3	0	0,6	2,1	0,28	4	50	2	40°	20°	1,5	▲
DSTM.2.040.000.030	0,4	0	0,7	1,2	0,38	4	50	2	20°	-	-	▲
DSTM.2.040.000.050	0,4	0	0,7	2,0	0,38	4	50	2	40°	20°	1,5	▲
DSTM.2.040.000.070	0,4	0	0,7	2,8	0,38	4	50	2	40°	20°	1,5	▲
DSTM.2.050.000.030	0,5	0	1,0	1,5	0,47	4	50	2	20°	-	-	▲
DSTM.2.050.000.050	0,5	0	1,0	2,5	0,47	4	50	2	40°	20°	1,5	▲
DSTM.2.050.000.070	0,5	0	1,0	3,5	0,47	4	50	2	40°	20°	1,5	▲
DSTM.2.050.010.030	0,5	0,1	1,0	1,5	0,47	4	50	2	20°	-	-	▲
DSTM.2.050.010.050	0,5	0,1	1,0	2,5	0,47	4	50	2	40°	20°	1,5	▲
DSTM.2.050.010.070	0,5	0,1	1,0	3,5	0,47	4	50	2	40°	20°	1,5	▲
DSTM.2.060.000.030	0,6	0	1,2	1,8	0,60	4	50	2	20°	-	-	▲
DSTM.2.060.000.050	0,6	0	1,2	3,0	0,55	4	50	2	40°	20°	1,5	▲
DSTM.2.060.000.070	0,6	0	1,2	4,2	0,55	4	50	2	40°	20°	1,5	▲
DSTM.2.060.010.030	0,6	0,1	1,2	1,8	0,55	4	50	2	20°	-	-	▲
DSTM.2.060.010.050	0,6	0,1	1,2	3,0	0,55	4	50	2	40°	20°	1,5	▲
DSTM.2.060.010.070	0,6	0,1	1,2	4,2	0,55	4	50	2	40°	20°	1,5	▲

▲ ab Lager / on stock Δ 4 Wochen / 4 weeks x auf Anfrage / upon request

● empfohlen / recommended

o bedingt einsetzbar / alternative recommendation

- nicht geeignet / not suitable

■ unbeschichtete HM-Sorten / uncoated grades

■ beschichtete HM-Sorten / coated grades

■ bestückt/Cermet / brazed/Cermet

Abmessungen in mm

Dimensions in mm



P	●
M	○
K	○
N	-
S	○
H	○



HM-Sorten  
Carbide grades

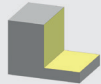

# Schnittdaten DSTM Ø 0,1 - 0,6 mm

## Cutting Data DSTM Ø 0,1 - 0,6 mm

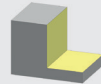

	 $vc = m/min$	 $vc = m/min$
P1.1	160	190
P1.2	160	190
P1.3	150	180
P2.1	140	170
P2.2	140	170
P2.3	140	170
P3.1	120	140
P3.2	110	130
M1.1	90	110
M2.1	80	100
M3.1	60	70

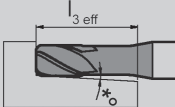
	 $vc = m/min$	 $vc = m/min$
K1.1	140	170
K1.2	130	160
K2.1	120	140
K2.2	100	120
K3.1	80	100
K3.2	70	80
S1	70	80
S2	55	70
S3	40	50
-	-	-
-	-	-

$d_1$	 $\alpha$	 $l_{3\text{eff}}$										
		0°	0,5°	1°	2°	3°	$f_z$	$a_e$	$a_p$	$f_z$	$a_e$	$a_p$
0,1	5°	0,3	0,3	0,3	0,3	0,4	0,004	0,01	0,02	0,005	0,01	0,01
0,1	5°	0,5	0,5	0,5	0,5	0,5	0,003	0,01	0,02	0,005	0,01	0,01
0,1	3°	0,7	0,7	0,7	0,8	0,9	0,003	0,01	0,01	0,004	0,01	0,01
0,2	5°	0,6	0,6	0,6	0,7	0,8	0,004	0,02	0,04	0,006	0,01	0,02
0,2	5°	1,0	1	1	1,1	1,1	0,004	0,02	0,03	0,005	0,01	0,02
0,2	3°	1,4	1,4	1,4	1,5	1,6	0,003	0,02	0,02	0,005	0,01	0,01
0,3	5°	0,9	0,9	0,9	1,1	1,2	0,005	0,03	0,06	0,007	0,02	0,03
0,3	5°	1,5	1,5	1,5	1,6	1,7	0,004	0,03	0,05	0,006	0,02	0,02
0,3	3°	2,1	2,1	2,2	2,3	2,4	0,004	0,03	0,03	0,006	0,02	0,02
0,4	5°	1,2	1,2	1,2	1,4	1,5	0,006	0,04	0,08	0,008	0,02	0,04
0,4	5°	2,0	2	2	2,1	2,2	0,005	0,04	0,06	0,007	0,02	0,03
0,4	3°	2,8	2,8	2,9	3	3,1	0,004	0,04	0,04	0,006	0,02	0,02
0,5	5°	1,5	1,5	1,6	1,8	2,1	0,006	0,05	0,10	0,009	0,03	0,05
0,5	5°	2,5	2,5	2,6	2,7	2,9	0,006	0,05	0,08	0,008	0,03	0,04
0,5	3°	3,5	3,5	3,6	3,8	4	0,005	0,05	0,05	0,007	0,03	0,03
0,5	5°	1,5	1,5	1,6	1,8	2	0,006	0,05	0,10	0,009	0,03	0,05
0,5	5°	2,5	2,5	2,6	2,7	2,9	0,006	0,05	0,08	0,008	0,03	0,04
0,5	3°	3,5	3,5	3,6	3,8	4	0,005	0,05	0,05	0,007	0,03	0,03
0,6	5°	1,8	1,8	1,9	2,2	2,5	0,007	0,06	0,12	0,010	0,03	0,06
0,6	5°	3,0	3	3,1	3,3	3,5	0,006	0,06	0,09	0,009	0,03	0,05
0,6	3°	4,2	4,2	4,4	4,6	4,9	0,005	0,06	0,06	0,008	0,03	0,04
0,6	5°	1,8	1,8	1,9	2,2	2,5	0,007	0,06	0,12	0,010	0,03	0,06
0,6	5°	3,0	3	3,1	3,3	3,4	0,006	0,06	0,09	0,009	0,03	0,05
0,6	3°	4,2	4,2	4,4	4,6	4,8	0,005	0,06	0,06	0,008	0,03	0,04

Abmessungen in mm  
Dimensions in mm

B

### DSTM

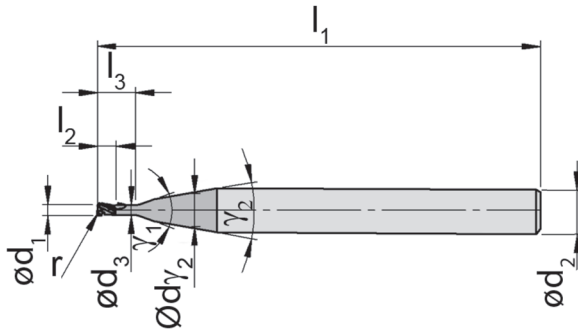
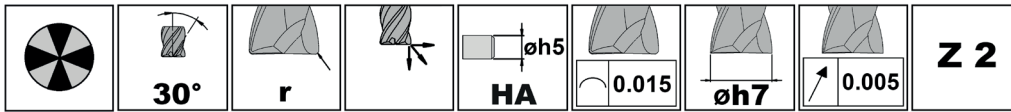

Bis Ø 3 mm vormontiert lieferbar für Toodle Schnelllaufspindel (siehe Seite D2)  
Pre-assembled available up to Ø 3 mm for Toodle high-speed spindle (see page D2)

Bestellnummer Part number	d <sub>1</sub>	r	l <sub>2</sub>	l <sub>3</sub>	d <sub>3</sub>	d <sub>2</sub>	l <sub>1</sub>	Z	γ <sub>1</sub>	γ <sub>2</sub>	d <sub>v2</sub>	TS3K
DSTM.2.070.000.030	0,7	0	1,4	2,1	0,65	4	50	2	20°	-	-	▲
DSTM.2.070.000.050	0,7	0	1,4	3,5	0,65	4	50	2	40°	20°	1,5	▲
DSTM.2.070.000.070	0,7	0	1,4	4,9	0,65	4	50	2	40°	20°	1,5	▲
DSTM.2.070.010.030	0,7	0,1	1,4	2,1	0,65	4	50	2	20°	-	-	▲
DSTM.2.070.010.050	0,7	0,1	1,4	3,5	0,65	4	50	2	40°	20°	1,5	▲
DSTM.2.070.010.070	0,7	0,1	1,4	4,9	0,65	4	50	2	40°	20°	1,5	▲
DSTM.2.080.000.030	0,8	0	1,6	2,4	0,75	4	50	2	20°	-	-	▲
DSTM.2.080.000.050	0,8	0	1,6	4,0	0,75	4	50	2	40°	20°	1,5	▲
DSTM.2.080.000.070	0,8	0	1,6	5,6	0,75	4	50	2	40°	20°	1,5	▲
DSTM.2.080.010.030	0,8	0,1	1,6	2,4	0,75	4	50	2	20°	-	-	▲
DSTM.2.080.010.050	0,8	0,1	1,6	4,0	0,75	4	50	2	40°	20°	1,5	▲
DSTM.2.080.010.070	0,8	0,1	1,6	5,6	0,75	4	50	2	40°	20°	1,5	▲
DSTM.2.090.000.030	0,9	0	1,8	2,7	0,85	4	50	2	20°	-	-	▲
DSTM.2.090.000.050	0,9	0	1,8	4,5	0,85	4	50	2	40°	20°	1,5	▲
DSTM.2.090.000.070	0,9	0	1,8	6,3	0,85	4	50	2	40°	20°	1,5	▲
DSTM.2.090.010.030	0,9	0,1	1,8	2,7	0,85	4	50	2	20°	-	-	▲
DSTM.2.090.010.050	0,9	0,1	1,8	4,5	0,85	4	50	2	40°	20°	1,5	▲
DSTM.2.090.010.070	0,9	0,1	1,8	6,3	0,85	4	50	2	40°	20°	1,5	▲
DSTM.2.100.000.030	1,0	0	2,0	3,0	0,95	4	50	2	20°	-	-	▲
DSTM.2.100.000.050	1,0	0	2,0	5,0	0,95	4	50	2	40°	20°	2,0	▲
DSTM.2.100.000.070	1,0	0	2,0	7,0	0,95	4	50	2	40°	20°	2,0	▲
DSTM.2.100.010.030	1,0	0,1	2,0	3,0	0,95	4	50	2	20°	-	-	▲
DSTM.2.100.010.050	1,0	0,1	2,0	5,0	0,95	4	50	2	40°	20°	2,0	▲
DSTM.2.100.010.070	1,0	0,1	2,0	7,0	0,95	4	50	2	40°	20°	2,0	▲
DSTM.2.100.020.030	1,0	0,2	2,0	3,0	0,95	4	50	2	20°	-	-	▲
DSTM.2.100.020.050	1,0	0,2	2,0	5,0	0,95	4	50	2	40°	20°	2,0	▲
DSTM.2.100.020.070	1,0	0,2	2,0	7,0	0,95	4	50	2	40°	20°	2,0	▲

▲ ab Lager / on stock Δ 4 Wochen / 4 weeks x auf Anfrage / upon request

● empfohlen / recommended

○ bedingt einsetzbar / alternative recommendation

- nicht geeignet / not suitable

■ unbeschichtete HM-Sorten / uncoated grades

■ beschichtete HM-Sorten / coated grades

■ bestückt/Cermet / brazed/Cermet

Abmessungen in mm

Dimensions in mm



P	●
M	○
K	○
N	-
S	○
H	○



HM-Sorten  
Carbide grades

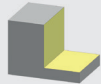

# Schnittdaten DSTM Ø 0,7 - 1 mm

## Cutting Data DSTM Ø 0,7 - 1 mm

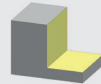

		
	vc = m/min	vc = m/min
P1.1	160	190
P1.2	160	190
P1.3	150	180
P2.1	140	170
P2.2	140	170
P2.3	140	170
P3.1	120	140
P3.2	110	130
M1.1	90	110
M2.1	80	100
M3.1	60	70

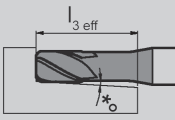
		
	vc = m/min	vc = m/min
K1.1	140	170
K1.2	130	160
K2.1	120	140
K2.2	100	120
K3.1	80	100
K3.2	70	80
S1	70	80
S2	55	70
S3	40	50
-	-	-
-	-	-

d <sub>1</sub>												
		0°	0,5°	1°	2°	3°	f <sub>z</sub>	a <sub>e</sub>	a <sub>p</sub>	f <sub>z</sub>	a <sub>e</sub>	a <sub>p</sub>
0,7	5°	2,1	2,1	2,2	2,5	2,8	0,007	0,07	0,14	0,010	0,04	0,07
0,7	5°	3,5	3,5	3,6	3,8	3,9	0,007	0,07	0,11	0,009	0,04	0,06
0,7	3°	4,9	4,9	5,1	5,3	5,5	0,006	0,07	0,07	0,008	0,04	0,04
0,7	5°	2,1	2,1	2,2	2,5	2,8	0,007	0,07	0,14	0,010	0,04	0,07
0,7	5°	3,5	3,5	3,6	3,8	3,9	0,007	0,07	0,11	0,009	0,04	0,06
0,7	3°	4,9	4,9	5,1	5,3	5,5	0,006	0,07	0,07	0,008	0,04	0,04
0,8	5°	2,4	2,5	2,6	2,9	3,3	0,008	0,08	0,16	0,011	0,04	0,08
0,8	5°	4,0	4	4,2	4,4	4,6	0,007	0,08	0,12	0,010	0,04	0,06
0,8	3°	5,6	5,7	5,8	6,1	6,5	0,006	0,08	0,08	0,009	0,04	0,05
0,8	5°	2,4	2,5	2,6	2,9	3,3	0,008	0,08	0,16	0,011	0,04	0,08
0,8	5°	4,0	4	4,2	4,4	4,6	0,007	0,08	0,12	0,010	0,04	0,06
0,8	3°	5,6	5,7	5,8	6,1	6,5	0,006	0,08	0,08	0,009	0,04	0,05
0,9	5°	2,7	2,8	2,9	3,2	3,6	0,009	0,09	0,18	0,012	0,05	0,09
0,9	5°	4,5	4,5	4,7	4,9	5,1	0,008	0,09	0,14	0,011	0,05	0,07
0,9	3°	6,3	6,4	6,5	6,8	7,2	0,007	0,09	0,09	0,010	0,05	0,05
0,9	5°	2,7	2,8	2,9	3,2	3,6	0,009	0,09	0,18	0,012	0,05	0,09
0,9	5°	4,5	4,5	4,7	4,9	5,1	0,008	0,09	0,14	0,011	0,05	0,07
0,9	3°	6,3	6,4	6,5	6,8	7,2	0,007	0,09	0,09	0,010	0,05	0,05
1,0	5°	3,0	3,1	3,3	3,7	4,2	0,009	0,10	0,20	0,013	0,05	0,10
1,0	5°	5,0	5,1	5,2	5,5	5,8	0,008	0,10	0,15	0,012	0,05	0,08
1,0	3°	7,0	7,1	7,3	7,7	8,1	0,007	0,10	0,10	0,011	0,05	0,06
1,0	5°	3,0	3,1	3,3	3,7	4,2	0,009	0,10	0,20	0,013	0,05	0,10
1,0	5°	5,0	5,1	5,2	5,5	5,8	0,008	0,10	0,15	0,012	0,05	0,08
1,0	3°	7,0	7,1	7,3	7,7	8,1	0,007	0,10	0,10	0,011	0,05	0,06
1,0	5°	3,0	3,1	3,3	3,7	4,2	0,009	0,10	0,20	0,013	0,05	0,10
1,0	5°	5,0	5,1	5,2	5,5	5,8	0,008	0,10	0,15	0,012	0,05	0,08
1,0	3°	7,0	7,1	7,3	7,7	8,1	0,007	0,10	0,10	0,011	0,05	0,06

Abmessungen in mm  
Dimensions in mm

B

### DSTM

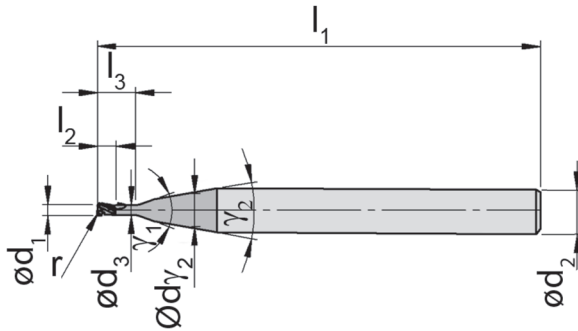
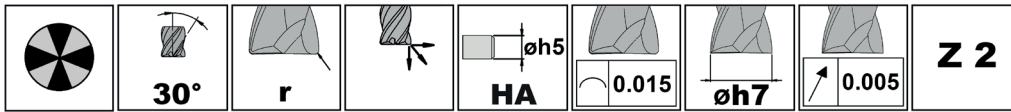

Bis Ø 3 mm vormontiert lieferbar für Toodle Schnelllaufspindel (siehe Seite D2)  
Pre-assembled available up to Ø 3 mm for Toodle high-speed spindle (see page D2)

Bestellnummer Part number	d <sub>1</sub>	r	l <sub>2</sub>	l <sub>3</sub>	d <sub>3</sub>	d <sub>2</sub>	l <sub>1</sub>	Z	γ <sub>1</sub>	γ <sub>2</sub>	d <sub>v2</sub>	TS3K
DSTM.2.120.000.030	1,2	0	2,4	3,6	1,15	4	50	2	20°	-	-	▲
DSTM.2.120.000.050	1,2	0	2,4	6,0	1,15	4	50	2	40°	20°	2,0	▲
DSTM.2.120.000.070	1,2	0	2,4	8,4	1,15	4	50	2	40°	20°	2,0	▲
DSTM.2.120.010.030	1,2	0,1	2,4	3,6	1,15	4	50	2	20°	-	-	▲
DSTM.2.120.010.050	1,2	0,1	2,4	6,0	1,15	4	50	2	40°	20°	2,0	▲
DSTM.2.120.010.070	1,2	0,1	2,4	8,4	1,15	4	50	2	40°	20°	2,0	▲
DSTM.2.120.020.030	1,2	0,2	2,4	3,6	1,15	4	50	2	20°	-	-	▲
DSTM.2.120.020.050	1,2	0,2	2,4	6,0	1,15	4	50	2	40°	20°	2,0	▲
DSTM.2.120.020.070	1,2	0,2	2,4	8,4	1,15	4	50	2	40°	20°	2,0	▲
DSTM.2.150.000.030	1,5	0	3,0	4,5	1,45	4	50	2	20°	-	-	▲
DSTM.2.150.000.050	1,5	0	3,0	7,5	1,45	4	50	2	40°	20°	2,5	▲
DSTM.2.150.000.070	1,5	0	3,0	10,5	1,45	4	50	2	40°	20°	2,5	▲
DSTM.2.150.010.030	1,5	0,1	3,0	4,5	1,45	4	50	2	20°	-	-	▲
DSTM.2.150.010.050	1,5	0,1	3,0	7,5	1,45	4	50	2	40°	20°	2,5	▲
DSTM.2.150.010.070	1,5	0,1	3,0	10,5	1,45	4	50	2	40°	20°	2,5	▲
DSTM.2.150.020.030	1,5	0,2	3,0	4,5	1,45	4	50	2	20°	-	-	▲
DSTM.2.150.020.050	1,5	0,2	3,0	7,5	1,45	4	50	2	40°	20°	2,5	▲
DSTM.2.150.020.070	1,5	0,2	3,0	10,5	1,45	4	50	2	40°	20°	2,5	▲
DSTM.2.150.050.030	1,5	0,5	3,0	4,5	1,45	4	50	2	20°	-	-	▲
DSTM.2.150.050.050	1,5	0,5	3,0	7,5	1,45	4	50	2	40°	20°	2,5	▲
DSTM.2.150.050.070	1,5	0,5	3,0	10,5	1,45	4	50	2	40°	20°	2,5	▲

▲ ab Lager / on stock Δ 4 Wochen / 4 weeks x auf Anfrage / upon request

● empfohlen / recommended

o bedingt einsetzbar / alternative recommendation

- nicht geeignet / not suitable

■ unbeschichtete HM-Sorten / uncoated grades

■ beschichtete HM-Sorten / coated grades

■ bestückt/Cermet / brazed/Cermet

Abmessungen in mm

Dimensions in mm



P	●
M	○
K	○
N	-
S	○
H	○



HM-Sorten  
Carbide grades

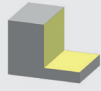

# Schnittdaten DSTM Ø 1,2 - 1,5 mm

## Cutting Data DSTM Ø 1,2 - 1,5 mm

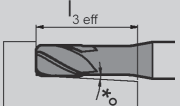
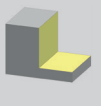

	 $vc = m/min$	 $vc = m/min$
P1.1	160	190
P1.2	160	190
P1.3	150	180
P2.1	140	170
P2.2	140	170
P2.3	140	170
P3.1	120	140
P3.2	110	130
M1.1	90	110
M2.1	80	100
M3.1	60	70

	 $vc = m/min$	 $vc = m/min$
K1.1	140	170
K1.2	130	160
K2.1	120	140
K2.2	100	120
K3.1	80	100
K3.2	70	80
S1	70	80
S2	55	70
S3	40	50
-	-	-
-	-	-

$d_1$	 $\alpha$	 $l_{3\text{eff}}$ , $\alpha_0$										
		0°	0,5°	1°	2°	3°	$f_z$	$a_e$	$a_p$	$f_z$	$a_e$	$a_p$
1,2	5°	3,6	3,7	3,9	4,4	5,1	0,011	0,12	0,24	0,015	0,06	0,12
1,2	5°	6,0	6,1	6,3	6,6	7	0,010	0,12	0,18	0,013	0,06	0,10
1,2	3°	8,4	8,6	8,8	9,2	10	0,008	0,12	0,12	0,012	0,06	0,07
1,2	5°	3,6	3,7	3,9	4,4	5	0,011	0,12	0,24	0,015	0,06	0,12
1,2	5°	6,0	6,1	6,3	6,6	6,9	0,010	0,12	0,18	0,013	0,06	0,10
1,2	3°	8,4	8,6	8,8	9,2	10	0,008	0,12	0,12	0,012	0,06	0,07
1,2	5°	3,6	3,7	3,9	4,4	5	0,011	0,12	0,24	0,015	0,06	0,12
1,2	5°	6,0	6,1	6,2	6,6	6,9	0,010	0,12	0,18	0,013	0,06	0,10
1,2	3°	8,4	8,5	8,8	9,2	10	0,008	0,12	0,12	0,012	0,06	0,07
1,5	5°	4,5	4,7	4,9	5,5	6,3	0,012	0,15	0,30	0,018	0,08	0,15
1,5	5°	7,5	7,6	7,8	8,2	8,7	0,011	0,15	0,23	0,016	0,08	0,12
1,5	3°	10,5	10,7	11	11,6	12,6	0,010	0,15	0,15	0,014	0,08	0,09
1,5	5°	4,5	4,7	4,9	5,5	6,3	0,012	0,15	0,30	0,018	0,08	0,15
1,5	5°	7,5	7,6	7,8	8,2	8,7	0,011	0,15	0,23	0,016	0,08	0,12
1,5	3°	10,5	10,7	11	11,6	12,6	0,010	0,15	0,15	0,014	0,08	0,09
1,5	5°	4,5	4,7	4,9	5,5	6,3	0,012	0,15	0,30	0,018	0,08	0,15
1,5	5°	7,5	7,6	7,8	8,2	8,7	0,011	0,15	0,23	0,016	0,08	0,12
1,5	3°	10,5	10,7	11	11,5	12,5	0,010	0,15	0,15	0,014	0,08	0,09
1,5	5°	4,5	4,7	4,9	5,4	6,2	0,012	0,15	0,30	0,018	0,08	0,15
1,5	5°	7,5	7,6	7,8	8,2	8,6	0,011	0,15	0,23	0,016	0,08	0,12
1,5	3°	10,5	10,7	11	11,5	12,4	0,010	0,15	0,15	0,014	0,08	0,09

Abmessungen in mm  
Dimensions in mm

B



### DSTM

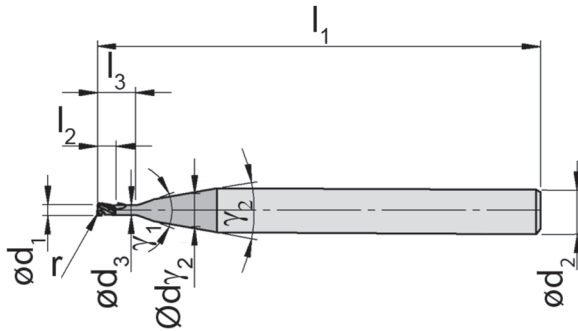
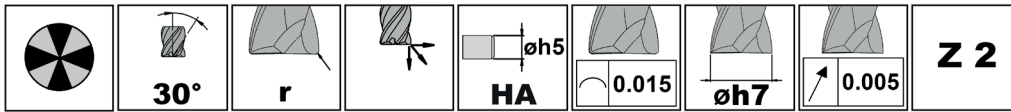

Bis Ø 3 mm vormontiert lieferbar für Toodle Schnelllaufspindel (siehe Seite D2)  
Pre-assembled available up to Ø 3 mm for Toodle high-speed spindle (see page D2)

Bestellnummer Part number	d <sub>1</sub>	r	l <sub>2</sub>	l <sub>3</sub>	d <sub>3</sub>	d <sub>2</sub>	l <sub>1</sub>	Z	γ <sub>1</sub>	γ <sub>2</sub>	d <sub>γ<sub>2</sub></sub>	TS3K
DSTM.2.200.000.030	2,0	0	4	6,0	1,9	4	50	2	20°	-	-	▲
DSTM.2.200.000.050	2,0	0	4	10,0	1,9	4	50	2	40°	20°	3,0	▲
DSTM.2.200.000.070	2,0	0	4	14,0	1,9	4	50	2	40°	20°	3,0	▲
DSTM.2.200.010.030	2,0	0,1	4	6,0	1,9	4	50	2	20°	-	-	▲
DSTM.2.200.010.050	2,0	0,1	4	10,0	1,9	4	50	2	40°	20°	3,0	▲
DSTM.2.200.010.070	2,0	0,1	4	14,0	1,9	4	50	2	40°	20°	3,0	▲
DSTM.2.200.020.030	2,0	0,2	4	6,0	1,9	4	50	2	20°	-	-	▲
DSTM.2.200.020.050	2,0	0,2	4	10,0	1,9	4	50	2	40°	20°	3,0	▲
DSTM.2.200.020.070	2,0	0,2	4	14,0	1,9	4	50	2	40°	20°	3,0	▲
DSTM.2.200.050.030	2,0	0,5	4	6,0	1,9	4	50	2	20°	-	-	▲
DSTM.2.200.050.050	2,0	0,5	4	10,0	1,9	4	50	2	40°	20°	3,0	▲
DSTM.2.200.050.070	2,0	0,5	4	14,0	1,9	4	50	2	40°	20°	3,0	▲
DSTM.2.250.000.030	2,5	0	5	7,5	2,4	4	50	2	20°	-	-	▲
DSTM.2.250.000.050	2,5	0	5	12,5	2,4	4	50	2	40°	20°	3,5	▲
DSTM.2.250.000.070	2,5	0	5	17,5	2,4	4	60	2	40°	20°	3,5	▲
DSTM.2.250.010.030	2,5	0,1	5	7,5	2,4	4	50	2	20°	-	-	▲
DSTM.2.250.010.050	2,5	0,1	5	12,5	2,4	4	50	2	40°	20°	3,5	▲
DSTM.2.250.010.070	2,5	0,1	5	17,5	2,4	4	60	2	40°	20°	3,5	▲
DSTM.2.250.020.030	2,5	0,2	5	7,5	2,4	4	50	2	20°	-	-	▲
DSTM.2.250.020.050	2,5	0,2	5	12,5	2,4	4	50	2	40°	20°	3,5	▲
DSTM.2.250.020.070	2,5	0,2	5	17,5	2,4	4	60	2	40°	20°	3,5	▲
DSTM.2.250.050.030	2,5	0,5	5	7,5	2,4	4	50	2	20°	-	-	▲
DSTM.2.250.050.050	2,5	0,5	5	12,5	2,4	4	50	2	40°	20°	3,5	▲
DSTM.2.250.050.070	2,5	0,5	5	17,5	2,4	4	60	2	40°	20°	3,5	▲

▲ ab Lager / on stock Δ 4 Wochen / 4 weeks x auf Anfrage / upon request

● empfohlen / recommended

o bedingt einsetzbar / alternative recommendation

- nicht geeignet / not suitable

■ unbeschichtete HM-Sorten / uncoated grades

■ beschichtete HM-Sorten / coated grades

■ bestückt/Cermet / brazed/Cermet

Abmessungen in mm

Dimensions in mm



P	●
M	○
K	○
N	-
S	○
H	○



HM-Sorten  
Carbide grades

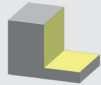

# Schnittdaten DSTM Ø 2 - 2,5 mm

## Cutting Data DSTM Ø 2 - 2,5 mm

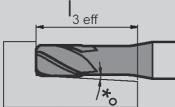

	 $vc = m/min$	 $vc = m/min$
P1.1	160	190
P1.2	160	190
P1.3	150	180
P2.1	140	170
P2.2	140	170
P2.3	140	170
P3.1	120	140
P3.2	110	130
M1.1	90	110
M2.1	80	100
M3.1	60	70

	 $vc = m/min$	 $vc = m/min$
K1.1	140	170
K1.2	130	160
K2.1	120	140
K2.2	100	120
K3.1	80	100
K3.2	70	80
S1	70	80
S2	55	70
S3	40	50
-	-	-
-	-	-

$d_1$	 $\alpha$	 $l_{3\text{eff}}$										
		0°	0,5°	1°	2°	3°	$f_z$	$a_e$	$a_p$	$f_z$	$a_e$	$a_p$
2,0	5°	6,0	6,3	6,6	7,4	8,5	0,016	0,20	0,40	0,022	0,10	0,20
2,0	5°	10,0	10,2	10,5	11	11,9	0,014	0,20	0,30	0,020	0,10	0,16
2,0	3°	14,0	14,3	14,7	15,4	17,6	0,013	0,20	0,20	0,018	0,10	0,12
2,0	5°	6,0	6,3	6,6	7,4	8,5	0,016	0,20	0,40	0,022	0,10	0,20
2,0	5°	10,0	10,2	10,5	11	11,9	0,014	0,20	0,30	0,020	0,10	0,16
2,0	3°	14,0	14,3	14,7	15,4	17,6	0,013	0,20	0,20	0,018	0,10	0,12
2,0	5°	6,0	6,3	6,6	7,4	8,4	0,016	0,20	0,40	0,022	0,10	0,20
2,0	5°	10,0	10,2	10,4	11	11,8	0,014	0,20	0,30	0,020	0,10	0,16
2,0	3°	14,0	14,3	14,7	15,4	17,5	0,013	0,20	0,20	0,018	0,10	0,12
2,0	5°	6,0	6,2	6,6	7,3	8,3	0,016	0,20	0,40	0,022	0,10	0,20
2,0	5°	10,0	11,7	11	10,4	10,2	0,014	0,20	0,30	0,020	0,10	0,16
2,0	3°	14,0	14,3	14,6	15,4	17,4	0,013	0,20	0,20	0,018	0,10	0,12
2,5	5°	7,5	7,8	8,3	9,3	10,6	0,019	0,25	0,50	0,027	0,13	0,25
2,5	5°	12,5	12,8	13,1	13,8	∞	0,017	0,25	0,38	0,024	0,13	0,20
2,5	3°	17,5	17,9	18,3	19,8	∞	0,015	0,25	0,25	0,021	0,13	0,15
2,5	5°	7,5	7,8	8,3	9,3	10,6	0,019	0,25	0,50	0,027	0,13	0,25
2,5	5°	12,5	12,8	13,1	13,8	∞	0,017	0,25	0,38	0,024	0,13	0,20
2,5	3°	17,5	17,9	18,3	19,8	∞	0,015	0,25	0,25	0,021	0,13	0,15
2,5	5°	7,5	7,8	8,3	9,3	10,5	0,019	0,25	0,50	0,027	0,13	0,25
2,5	5°	12,5	12,8	13,1	13,8	∞	0,017	0,25	0,38	0,024	0,13	0,20
2,5	3°	17,5	17,9	18,3	19,7	∞	0,015	0,25	0,25	0,021	0,13	0,15
2,5	5°	7,5	7,8	8,2	9,2	10,4	0,019	0,25	0,50	0,027	0,13	0,25
2,5	5°	12,5	12,7	13,1	13,7	∞	0,017	0,25	0,38	0,024	0,13	0,20
2,5	3°	17,5	17,9	18,3	19,7	∞	0,015	0,25	0,25	0,021	0,13	0,15

Abmessungen in mm  
Dimensions in mm

B

### DSTM

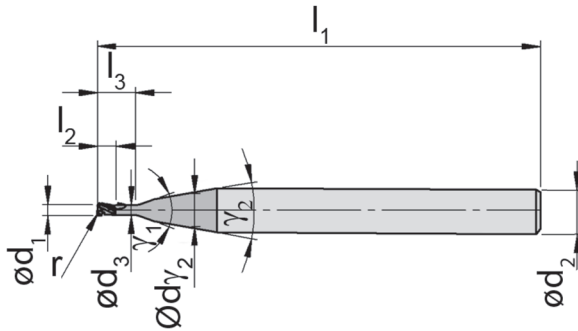
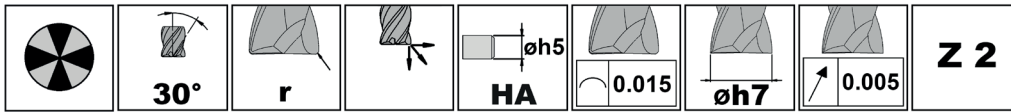

Bis Ø 3 mm vormontiert lieferbar für Toodle Schnelllaufspindel (siehe Seite D2)  
Pre-assembled available up to Ø 3 mm for Toodle high-speed spindle (see page D2)

Bestellnummer Part number	d <sub>1</sub>	r	l <sub>2</sub>	l <sub>3</sub>	d <sub>3</sub>	d <sub>2</sub>	l <sub>1</sub>	Z	γ <sub>1</sub>	γ <sub>2</sub>	d <sub>v2</sub>	TS3K
DSTM.2.300.000.030	3	0	6	9	2,9	4	50	2	20°	-	-	▲
DSTM.2.300.000.050	3	0	6	15	2,9	4	50	2	40°	20°	3,5	▲
DSTM.2.300.000.070	3	0	6	21	2,9	4	60	2	40°	20°	3,5	▲
DSTM.2.300.010.030	3	0,1	6	9	2,9	4	50	2	20°	-	-	▲
DSTM.2.300.010.050	3	0,1	6	15	2,9	4	50	2	40°	20°	3,5	▲
DSTM.2.300.010.070	3	0,1	6	21	2,9	4	60	2	40°	20°	3,5	▲
DSTM.2.300.020.030	3	0,2	6	9	2,9	4	50	2	20°	-	-	▲
DSTM.2.300.020.050	3	0,2	6	15	2,9	4	50	2	40°	20°	3,5	▲
DSTM.2.300.020.070	3	0,2	6	21	2,9	4	60	2	40°	20°	3,5	▲
DSTM.2.300.050.030	3	0,5	6	9	2,9	4	50	2	20°	-	-	▲
DSTM.2.300.050.050	3	0,5	6	15	2,9	4	50	2	40°	20°	3,5	▲
DSTM.2.300.050.070	3	0,5	6	21	2,9	4	60	2	40°	20°	3,5	▲
DSTM.2.300.100.030	3	1,0	6	9	2,9	4	50	2	20°	-	-	▲
DSTM.2.300.100.050	3	1,0	6	15	2,9	4	50	2	40°	20°	3,5	▲
DSTM.2.300.100.070	3	1,0	6	21	2,9	4	60	2	40°	20°	3,5	▲

▲ ab Lager / on stock Δ 4 Wochen / 4 weeks x auf Anfrage / upon request

● empfohlen / recommended

o bedingt einsetzbar / alternative recommendation

- nicht geeignet / not suitable

■ unbeschichtete HM-Sorten / uncoated grades

■ beschichtete HM-Sorten / coated grades

■ bestückt/Cermet / brazed/Cermet

Abmessungen in mm

Dimensions in mm



P	●
M	○
K	○
N	-
S	○
H	○



HM-Sorten  
Carbide grades

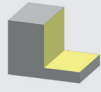

# Schnittdaten DSTM Ø 3 mm

## Cutting Data DSTM Ø 3 mm

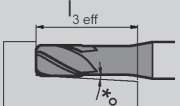
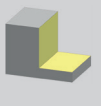

	 $vc = m/min$	 $vc = m/min$
P1.1	160	190
P1.2	160	190
P1.3	150	180
P2.1	140	170
P2.2	140	170
P2.3	140	170
P3.1	120	140
P3.2	110	130
M1.1	90	110
M2.1	80	100
M3.1	60	70

	 $vc = m/min$	 $vc = m/min$
K1.1	140	170
K1.2	130	160
K2.1	120	140
K2.2	100	120
K3.1	80	100
K3.2	70	80
S1	70	80
S2	55	70
S3	40	50
-	-	-
-	-	-

$d_1$	 $\alpha$	 $l_{3\text{eff}}$										
		0°	0,5°	1°	2°	3°	$f_z$	$a_e$	$a_p$	$f_z$	$a_e$	$a_p$
3	5°	9,0	9,4	9,9	11,2	12,7	0,022	0,30	0,60	0,031	0,15	0,30
3	5°	15,0	15,3	15,7	∞	∞	0,020	0,30	0,45	0,028	0,15	0,24
3	3°	21,0	21,5	22,3	∞	∞	0,018	0,30	0,30	0,025	0,15	0,18
3	5°	9,0	9,4	9,9	11,2	12,7	0,022	0,30	0,60	0,031	0,15	0,30
3	5°	15,0	15,3	15,7	∞	∞	0,020	0,30	0,45	0,028	0,15	0,24
3	3°	21,0	21,5	22,3	∞	∞	0,018	0,30	0,30	0,025	0,15	0,18
3	5°	9,0	9,4	9,9	11,1	∞	0,022	0,30	0,60	0,031	0,15	0,30
3	5°	15,0	15,3	15,7	∞	∞	0,020	0,30	0,45	0,028	0,15	0,24
3	3°	21,0	21,5	22,3	∞	∞	0,018	0,30	0,30	0,025	0,15	0,18
3	5°	9,0	9,4	9,9	11,1	∞	0,022	0,30	0,60	0,031	0,15	0,30
3	5°	15,0	15,3	15,7	∞	∞	0,020	0,30	0,45	0,028	0,15	0,24
3	3°	21,0	21,5	22,2	∞	∞	0,018	0,30	0,30	0,025	0,15	0,18
3	5°	9,0	9,4	9,8	10,9	∞	0,022	0,30	0,60	0,031	0,15	0,30
3	5°	15,0	15,3	15,7	∞	∞	0,020	0,30	0,45	0,028	0,15	0,24
3	3°	21,0	21,4	22,2	∞	∞	0,018	0,30	0,30	0,025	0,15	0,18

Abmessungen in mm  
Dimensions in mm

B

### DSTM

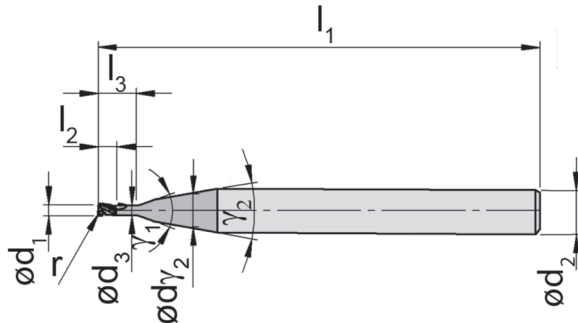
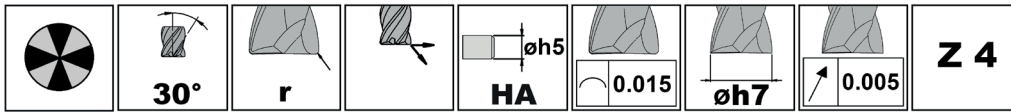

Bis Ø 3 mm vormontiert lieferbar für Toodle Schnelllaufspindel (siehe Seite D2)  
Pre-assembled available up to Ø 3 mm for Toodle high-speed spindle (see page D2)

Bestellnummer Part number	d <sub>1</sub>	r	l <sub>2</sub>	l <sub>3</sub>	d <sub>3</sub>	d <sub>2</sub>	l <sub>1</sub>	Z	γ <sub>1</sub>	γ <sub>2</sub>	d <sub>y2</sub>	TS3K
DSTM.4.020.000.030	0,2	0	0,4	0,6	0,18	4	50	4	20°	-	-	▲
DSTM.4.020.000.050	0,2	0	0,4	1,0	0,18	4	50	4	40°	20°	1,5	▲
DSTM.4.020.000.070	0,2	0	0,4	1,4	0,18	4	50	4	40°	20°	1,5	▲
DSTM.4.030.000.030	0,3	0	0,6	0,9	0,28	4	50	4	20°	-	-	▲
DSTM.4.030.000.050	0,3	0	0,6	1,5	0,28	4	50	4	40°	20°	1,5	▲
DSTM.4.030.000.070	0,3	0	0,6	2,1	0,28	4	50	4	40°	20°	1,5	▲
DSTM.4.040.000.030	0,4	0	0,7	1,2	0,38	4	50	4	20°	-	-	▲
DSTM.4.040.000.050	0,4	0	0,7	2,0	0,38	4	50	4	40°	20°	1,5	▲
DSTM.4.040.000.070	0,4	0	0,7	2,8	0,38	4	50	4	40°	20°	1,5	▲
DSTM.4.050.000.030	0,5	0	1,0	1,5	0,47	4	50	4	20°	-	-	▲
DSTM.4.050.000.050	0,5	0	1,0	2,5	0,47	4	50	4	40°	20°	1,5	▲
DSTM.4.050.000.070	0,5	0	1,0	3,5	0,47	4	50	4	40°	20°	1,5	▲
DSTM.4.050.010.030	0,5	0,1	1,0	1,5	0,47	4	50	4	20°	-	-	▲
DSTM.4.050.010.050	0,5	0,1	1,0	2,5	0,47	4	50	4	40°	20°	1,5	▲
DSTM.4.050.010.070	0,5	0,1	1,0	3,5	0,47	4	50	4	40°	20°	1,5	▲
DSTM.4.060.000.030	0,6	0	1,2	1,8	0,60	4	50	4	20°	-	-	▲
DSTM.4.060.000.050	0,6	0	1,2	3,0	0,55	4	50	4	40°	20°	1,5	▲
DSTM.4.060.000.070	0,6	0	1,2	4,2	0,55	4	50	4	40°	20°	1,5	▲
DSTM.4.060.010.030	0,6	0,1	1,2	1,8	0,55	4	50	4	20°	-	-	▲
DSTM.4.060.010.050	0,6	0,1	1,2	3,0	0,55	4	50	4	40°	20°	1,5	▲
DSTM.4.060.010.070	0,6	0,1	1,2	4,2	0,55	4	50	4	40°	20°	1,5	▲

▲ ab Lager / on stock Δ 4 Wochen / 4 weeks x auf Anfrage / upon request

● empfohlen / recommended

o bedingt einsetzbar / alternative recommendation

- nicht geeignet / not suitable

■ unbeschichtete HM-Sorten / uncoated grades

■ beschichtete HM-Sorten / coated grades

■ bestückt/Cermet / brazed/Cermet

Abmessungen in mm

Dimensions in mm



P	●
M	○
K	○
N	-
S	○
H	○



HM-Sorten  
Carbide grades

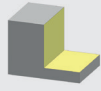

# Schnittdaten DSTM Ø 0,2 - 0,6 mm

## Cutting Data DSTM Ø 0,2 - 0,6 mm

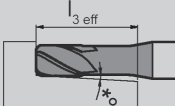

	 vc = m/min	 vc = m/min
P1.1	160	190
P1.2	160	190
P1.3	150	180
P2.1	140	170
P2.2	140	170
P2.3	140	170
P3.1	120	140
P3.2	110	130
M1.1	90	110
M2.1	80	100
M3.1	60	70

	 vc = m/min	 vc = m/min
K1.1	140	170
K1.2	130	160
K2.1	120	140
K2.2	100	120
K3.1	80	100
K3.2	70	80
S1	70	80
S2	55	70
S3	40	50
-	-	-
-	-	-

d <sub>1</sub>												
		0°	0,5°	1°	2°	3°	f <sub>z</sub>	a <sub>e</sub>	a <sub>p</sub>	f <sub>z</sub>	a <sub>e</sub>	a <sub>p</sub>
0,2	4°	0,6	0,6	0,6	0,7	0,8	0,004	0,02	0,04	0,006	0,01	0,02
0,2	4°	1,0	1	1	1,1	1,1	0,004	0,02	0,03	0,005	0,01	0,02
0,2	3°	1,4	1,4	1,4	1,5	1,6	0,003	0,02	0,02	0,004	0,01	0,01
0,3	4°	0,9	0,9	0,9	1,1	1,2	0,005	0,03	0,06	0,006	0,02	0,03
0,3	4°	1,5	1,5	1,5	1,6	1,7	0,004	0,03	0,05	0,006	0,02	0,02
0,3	3°	2,1	2,1	2,2	2,3	2,4	0,004	0,03	0,03	0,005	0,02	0,02
0,4	4°	1,2	1,2	1,2	1,4	1,5	0,005	0,04	0,08	0,007	0,02	0,04
0,4	4°	2,0	2	2	2,1	2,2	0,005	0,04	0,06	0,007	0,02	0,03
0,4	3°	2,8	2,8	2,9	3	3,1	0,004	0,04	0,04	0,006	0,02	0,02
0,5	4°	1,5	1,5	1,6	1,8	2,1	0,006	0,05	0,10	0,008	0,03	0,05
0,5	4°	2,5	2,5	2,6	2,7	2,9	0,005	0,05	0,08	0,007	0,03	0,04
0,5	3°	3,5	3,5	3,6	3,8	4	0,005	0,05	0,05	0,007	0,03	0,03
0,5	4°	1,5	1,5	1,6	1,8	2	0,006	0,05	0,10	0,008	0,03	0,05
0,5	4°	2,5	2,5	2,6	2,7	2,9	0,005	0,05	0,08	0,007	0,03	0,04
0,5	3°	3,5	3,5	3,6	3,8	4	0,005	0,05	0,05	0,007	0,03	0,03
0,6	4°	1,8	1,8	1,9	2,2	2,5	0,006	0,06	0,12	0,009	0,03	0,06
0,6	4°	3,0	3	3,1	3,3	3,5	0,006	0,06	0,09	0,008	0,03	0,05
0,6	3°	4,2	4,2	4,4	4,6	4,9	0,005	0,06	0,06	0,007	0,03	0,04
0,6	4°	1,8	1,8	1,9	2,2	2,5	0,006	0,06	0,12	0,009	0,03	0,06
0,6	4°	3,0	3	3,1	3,3	3,4	0,006	0,06	0,09	0,008	0,03	0,05
0,6	3°	4,2	4,2	4,4	4,6	4,8	0,005	0,06	0,06	0,007	0,03	0,04

Abmessungen in mm  
Dimensions in mm

B

### DSTM

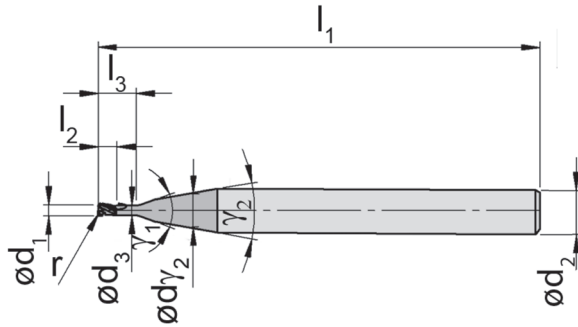
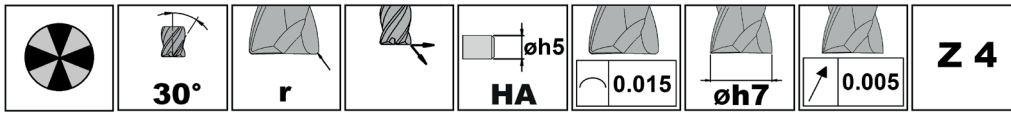

Bis Ø 3 mm vormontiert lieferbar für Toodle Schnelllaufspindel (siehe Seite D2)  
Pre-assembled available up to Ø 3 mm for Toodle high-speed spindle (see page D2)

Bestellnummer Part number	d <sub>1</sub>	r	l <sub>2</sub>	l <sub>3</sub>	d <sub>3</sub>	d <sub>2</sub>	l <sub>1</sub>	Z	γ <sub>1</sub>	γ <sub>2</sub>	d <sub>v2</sub>	TS3K
DSTM.4.070.000.030	0,7	0	1,4	2,1	0,65	4	50	4	20°	-	-	▲
DSTM.4.070.000.050	0,7	0	1,4	3,5	0,65	4	50	4	40°	20°	1,5	▲
DSTM.4.070.000.070	0,7	0	1,4	4,9	0,65	4	50	4	40°	20°	1,5	▲
DSTM.4.070.010.030	0,7	0,1	1,4	2,1	0,65	4	50	4	20°	-	-	▲
DSTM.4.070.010.050	0,7	0,1	1,4	3,5	0,65	4	50	4	40°	20°	1,5	▲
DSTM.4.070.010.070	0,7	0,1	1,4	4,9	0,65	4	50	4	40°	20°	1,5	▲
DSTM.4.080.000.030	0,8	0	1,6	2,4	0,75	4	50	4	20°	-	-	▲
DSTM.4.080.000.050	0,8	0	1,6	4,0	0,75	4	50	4	40°	20°	1,5	▲
DSTM.4.080.000.070	0,8	0	1,6	5,6	0,75	4	50	4	40°	20°	1,5	▲
DSTM.4.080.010.030	0,8	0,1	1,6	2,4	0,75	4	50	4	20°	-	-	▲
DSTM.4.080.010.050	0,8	0,1	1,6	4,0	0,75	4	50	4	40°	20°	1,5	▲
DSTM.4.080.010.070	0,8	0,1	1,6	5,6	0,75	4	50	4	40°	20°	1,5	▲
DSTM.4.090.000.030	0,9	0	1,8	2,7	0,85	4	50	4	20°	-	-	▲
DSTM.4.090.000.050	0,9	0	1,8	4,5	0,85	4	50	4	40°	20°	1,5	▲
DSTM.4.090.000.070	0,9	0	1,8	6,3	0,85	4	50	4	40°	20°	1,5	▲
DSTM.4.090.010.030	0,9	0,1	1,8	2,7	0,85	4	50	4	20°	-	-	▲
DSTM.4.090.010.050	0,9	0,1	1,8	4,5	0,85	4	50	4	40°	20°	1,5	▲
DSTM.4.090.010.070	0,9	0,1	1,8	6,3	0,85	4	50	4	40°	20°	1,5	▲
DSTM.4.100.000.030	1,0	0	2,0	3,0	0,95	4	50	4	20°	-	-	▲
DSTM.4.100.000.050	1,0	0	2,0	5,0	0,95	4	50	4	40°	20°	2,0	▲
DSTM.4.100.000.070	1,0	0	2,0	7,0	0,95	4	50	4	40°	20°	2,0	▲
DSTM.4.100.010.030	1,0	0,1	2,0	3,0	0,95	4	50	4	20°	-	-	▲
DSTM.4.100.010.050	1,0	0,1	2,0	5,0	0,95	4	50	4	40°	20°	2,0	▲
DSTM.4.100.010.070	1,0	0,1	2,0	7,0	0,95	4	50	4	40°	20°	2,0	▲
DSTM.4.100.020.030	1,0	0,2	2,0	3,0	0,95	4	50	4	20°	-	-	▲
DSTM.4.100.020.050	1,0	0,2	2,0	5,0	0,95	4	50	4	40°	20°	2,0	▲
DSTM.4.100.020.070	1,0	0,2	2,0	7,0	0,95	4	50	4	40°	20°	2,0	▲

▲ ab Lager / on stock Δ 4 Wochen / 4 weeks x auf Anfrage / upon request

● empfohlen / recommended

○ bedingt einsetzbar / alternative recommendation

- nicht geeignet / not suitable

■ unbeschichtete HM-Sorten / uncoated grades

■ beschichtete HM-Sorten / coated grades

■ bestückt/Cermet / brazed/Cermet

P	●
M	○
K	○
N	-
S	○
H	○

Abmessungen in mm

Dimensions in mm



B20



HM-Sorten  
Carbide grades

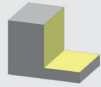

# Schnittdaten DSTM Ø 0,7 - 1 mm

## Cutting Data DSTM Ø 0,7 - 1 mm

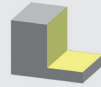

		
	vc = m/min	vc = m/min
P1.1	160	190
P1.2	160	190
P1.3	150	180
P2.1	140	170
P2.2	140	170
P2.3	140	170
P3.1	120	140
P3.2	110	130
M1.1	90	110
M2.1	80	100
M3.1	60	70

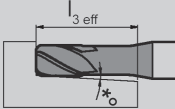
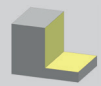
		
	vc = m/min	vc = m/min
K1.1	140	170
K1.2	130	160
K2.1	120	140
K2.2	100	120
K3.1	80	100
K3.2	70	80
S1	70	80
S2	55	70
S3	40	50
-	-	-
-	-	-

d <sub>1</sub>												
		0°	0,5°	1°	2°	3°	f <sub>z</sub>	a <sub>e</sub>	a <sub>p</sub>	f <sub>z</sub>	a <sub>e</sub>	a <sub>p</sub>
0,7	4°	2,1	2,1	2,2	2,5	2,8	0,007	0,07	0,14	0,010	0,04	0,07
0,7	4°	3,5	3,5	3,6	3,8	3,9	0,006	0,07	0,11	0,009	0,04	0,06
0,7	3°	4,9	4,9	5,1	5,3	5,5	0,006	0,07	0,07	0,008	0,04	0,04
0,7	4°	2,1	2,1	2,2	2,5	2,8	0,007	0,07	0,14	0,010	0,04	0,07
0,7	4°	3,5	3,5	3,6	3,8	3,9	0,006	0,07	0,11	0,009	0,04	0,06
0,7	3°	4,9	4,9	5,1	5,3	5,5	0,006	0,07	0,07	0,008	0,04	0,04
0,8	4°	2,4	2,5	2,6	2,9	3,3	0,008	0,08	0,16	0,011	0,04	0,08
0,8	4°	4,0	4	4,2	4,4	4,6	0,007	0,08	0,12	0,010	0,04	0,06
0,8	3°	5,6	5,7	5,8	6,1	6,5	0,006	0,08	0,08	0,009	0,04	0,05
0,8	4°	2,4	2,5	2,6	2,9	3,3	0,008	0,08	0,16	0,011	0,04	0,08
0,8	4°	4,0	4	4,2	4,4	4,6	0,007	0,08	0,12	0,010	0,04	0,06
0,8	3°	5,6	5,7	5,8	6,1	6,5	0,006	0,08	0,08	0,009	0,04	0,05
0,9	4°	2,7	2,8	2,9	3,2	3,6	0,008	0,09	0,18	0,012	0,05	0,09
0,9	4°	4,5	4,5	4,7	4,9	5,1	0,008	0,09	0,14	0,011	0,05	0,07
0,9	3°	6,3	6,4	6,5	6,8	7,2	0,007	0,09	0,09	0,009	0,05	0,05
0,9	4°	2,7	2,8	2,9	3,2	3,6	0,008	0,09	0,18	0,012	0,05	0,09
0,9	4°	4,5	4,5	4,7	4,9	5,1	0,008	0,09	0,14	0,011	0,05	0,07
0,9	3°	6,3	6,4	6,5	6,8	7,2	0,007	0,09	0,09	0,009	0,05	0,05
1,0	4°	3,0	3,1	3,3	3,7	4,2	0,009	0,10	0,20	0,013	0,05	0,10
1,0	4°	5,0	5,1	5,2	5,5	5,8	0,008	0,10	0,15	0,011	0,05	0,08
1,0	3°	7,0	7,1	7,3	7,7	8,1	0,007	0,10	0,10	0,010	0,05	0,06
1,0	4°	3,0	3,1	3,3	3,7	4,2	0,009	0,10	0,20	0,013	0,05	0,10
1,0	4°	5,0	5,1	5,2	5,5	5,8	0,008	0,10	0,15	0,011	0,05	0,08
1,0	3°	7,0	7,1	7,3	7,7	8,1	0,007	0,10	0,10	0,010	0,05	0,06
1,0	4°	3,0	3,1	3,3	3,7	4,2	0,009	0,10	0,20	0,013	0,05	0,10
1,0	4°	5,0	5,1	5,2	5,5	5,8	0,008	0,10	0,15	0,011	0,05	0,08
1,0	3°	7,0	7,1	7,3	7,7	8,1	0,007	0,10	0,10	0,010	0,05	0,06

Abmessungen in mm  
Dimensions in mm

B



### DSTM

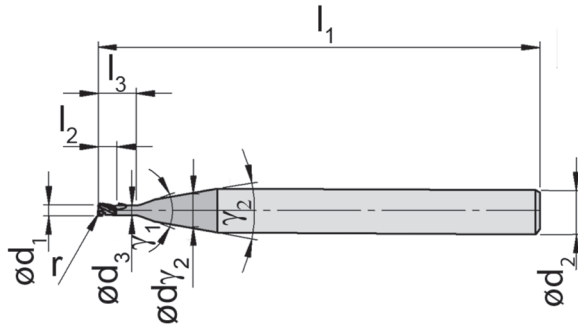
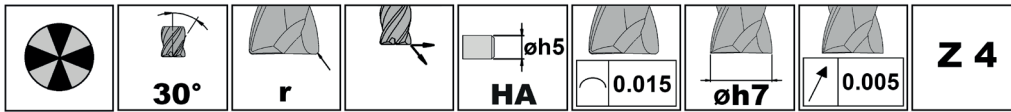

Bis Ø 3 mm vormontiert lieferbar für Toodle Schnelllaufspindel (siehe Seite D2)  
Pre-assembled available up to Ø 3 mm for Toodle high-speed spindle (see page D2)

Bestellnummer Part number	d <sub>1</sub>	r	l <sub>2</sub>	l <sub>3</sub>	d <sub>3</sub>	d <sub>2</sub>	l <sub>1</sub>	Z	γ <sub>1</sub>	γ <sub>2</sub>	d <sub>v2</sub>	TS3K
DSTM.4.120.000.030	1,2	0	2,4	3,6	1,15	4	50	4	20°	-	-	▲
DSTM.4.120.000.050	1,2	0	2,4	6,0	1,15	4	50	4	40°	20°	2,0	▲
DSTM.4.120.000.070	1,2	0	2,4	8,4	1,15	4	50	4	40°	20°	2,0	▲
DSTM.4.120.010.030	1,2	0,1	2,4	3,6	1,15	4	50	4	20°	-	-	▲
DSTM.4.120.010.050	1,2	0,1	2,4	6,0	1,15	4	50	4	40°	20°	2,0	▲
DSTM.4.120.010.070	1,2	0,1	2,4	8,4	1,15	4	50	4	40°	20°	2,0	▲
DSTM.4.120.020.030	1,2	0,2	2,4	3,6	1,15	4	50	4	20°	-	-	▲
DSTM.4.120.020.050	1,2	0,2	2,4	6,0	1,15	4	50	4	40°	20°	2,0	▲
DSTM.4.120.020.070	1,2	0,2	2,4	8,4	1,15	4	50	4	40°	20°	2,0	▲
DSTM.4.150.000.030	1,5	0	3,0	4,5	1,45	4	50	4	20°	-	-	▲
DSTM.4.150.000.050	1,5	0	3,0	7,5	1,45	4	50	4	40°	20°	2,5	▲
DSTM.4.150.000.070	1,5	0	3,0	10,5	1,45	4	50	4	40°	20°	2,5	▲
DSTM.4.150.010.030	1,5	0,1	3,0	4,5	1,45	4	50	4	20°	-	-	▲
DSTM.4.150.010.050	1,5	0,1	3,0	7,5	1,45	4	50	4	40°	20°	2,5	▲
DSTM.4.150.010.070	1,5	0,1	3,0	10,5	1,45	4	50	4	40°	20°	2,5	▲
DSTM.4.150.020.030	1,5	0,2	3,0	4,5	1,45	4	50	4	20°	-	-	▲
DSTM.4.150.020.050	1,5	0,2	3,0	7,5	1,45	4	50	4	40°	20°	2,5	▲
DSTM.4.150.020.070	1,5	0,2	3,0	10,5	1,45	4	50	4	40°	20°	2,5	▲
DSTM.4.150.050.030	1,5	0,5	3,0	4,5	1,45	4	50	4	20°	-	-	▲
DSTM.4.150.050.050	1,5	0,5	3,0	7,5	1,45	4	50	4	40°	20°	2,5	▲
DSTM.4.150.050.070	1,5	0,5	3,0	10,5	1,45	4	50	4	40°	20°	2,5	▲

▲ ab Lager / on stock Δ 4 Wochen / 4 weeks x auf Anfrage / upon request

● empfohlen / recommended

o bedingt einsetzbar / alternative recommendation

- nicht geeignet / not suitable

■ unbeschichtete HM-Sorten / uncoated grades

■ beschichtete HM-Sorten / coated grades

■ bestückt/Cermet / brazed/Cermet

Abmessungen in mm

Dimensions in mm



P	●
M	○
K	○
N	-
S	○
H	○



HM-Sorten  
Carbide grades

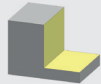

# Schnittdaten DSTM Ø 1,2 - 1,5 mm

## Cutting Data DSTM Ø 1,2 - 1,5 mm

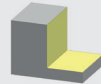

	 $vc = m/min$	 $vc = m/min$
P1.1	160	190
P1.2	160	190
P1.3	150	180
P2.1	140	170
P2.2	140	170
P2.3	140	170
P3.1	120	140
P3.2	110	130
M1.1	90	110
M2.1	80	100
M3.1	60	70

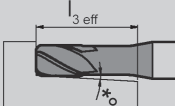
	 $vc = m/min$	 $vc = m/min$
K1.1	140	170
K1.2	130	160
K2.1	120	140
K2.2	100	120
K3.1	80	100
K3.2	70	80
S1	70	80
S2	55	70
S3	40	50
-	-	-
-	-	-

$d_1$	 $\alpha$	 $l_{3\text{eff}}$										
		0°	0,5°	1°	2°	3°	$f_z$	$a_e$	$a_p$	$f_z$	$a_e$	$a_p$
1,2	4°	3,6	3,7	3,9	4,4	5,1	0,010	0,12	0,24	0,014	0,06	0,12
1,2	4°	6,0	6,1	6,3	6,6	7	0,009	0,12	0,18	0,013	0,06	0,10
1,2	3°	8,4	8,6	8,8	9,2	10	0,008	0,12	0,12	0,012	0,06	0,07
1,2	4°	3,6	3,7	3,9	4,4	5	0,010	0,12	0,24	0,014	0,06	0,12
1,2	4°	6,0	6,1	6,3	6,6	6,9	0,009	0,12	0,18	0,013	0,06	0,10
1,2	3°	8,4	8,6	8,8	9,2	10	0,008	0,12	0,12	0,012	0,06	0,07
1,2	4°	3,6	3,7	3,9	4,4	5	0,010	0,12	0,24	0,014	0,06	0,12
1,2	4°	6,0	6,1	6,2	6,6	6,9	0,009	0,12	0,18	0,013	0,06	0,10
1,2	3°	8,4	8,5	8,8	9,2	10	0,008	0,12	0,12	0,012	0,06	0,07
1,5	4°	4,5	4,7	4,9	5,5	6,3	0,012	0,15	0,30	0,017	0,08	0,15
1,5	4°	7,5	7,6	7,8	8,2	8,7	0,011	0,15	0,23	0,015	0,08	0,12
1,5	3°	10,5	10,7	11	11,6	12,6	0,010	0,15	0,15	0,014	0,08	0,09
1,5	4°	4,5	4,7	4,9	5,5	6,3	0,012	0,15	0,30	0,017	0,08	0,15
1,5	4°	7,5	7,6	7,8	8,2	8,7	0,011	0,15	0,23	0,015	0,08	0,12
1,5	3°	10,5	10,7	11	11,6	12,6	0,010	0,15	0,15	0,014	0,08	0,09
1,5	4°	4,5	4,7	4,9	5,5	6,3	0,012	0,15	0,30	0,017	0,08	0,15
1,5	4°	7,5	7,6	7,8	8,2	8,7	0,011	0,15	0,23	0,015	0,08	0,12
1,5	3°	10,5	10,7	11	11,5	12,5	0,010	0,15	0,15	0,014	0,08	0,09
1,5	4°	4,5	4,7	4,9	5,4	6,2	0,012	0,15	0,30	0,017	0,08	0,15
1,5	4°	7,5	7,6	7,8	8,2	8,6	0,011	0,15	0,23	0,015	0,08	0,12
1,5	3°	10,5	10,7	11	11,5	12,4	0,010	0,15	0,15	0,014	0,08	0,09

Abmessungen in mm  
Dimensions in mm

B

### DSTM

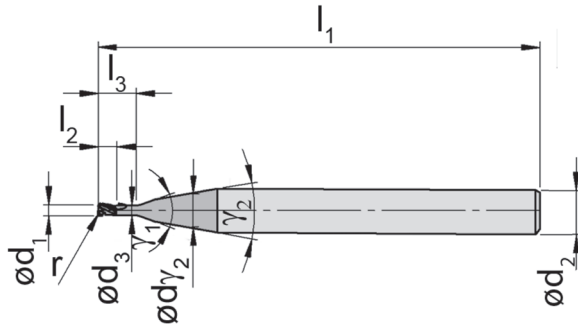
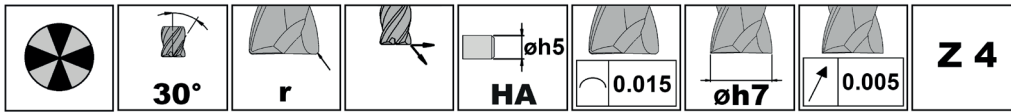

Bis Ø 3 mm vormontiert lieferbar für Toodle Schnelllaufspindel (siehe Seite D2)  
Pre-assembled available up to Ø 3 mm for Toodle high-speed spindle (see page D2)

Bestellnummer Part number	d <sub>1</sub>	r	l <sub>2</sub>	l <sub>3</sub>	d <sub>3</sub>	d <sub>2</sub>	l <sub>1</sub>	Z	γ <sub>1</sub>	γ <sub>2</sub>	d <sub>v2</sub>	TS3K
DSTM.4.200.000.030	2,0	0	4	6,0	1,9	4	50	4	20°	-	-	▲
DSTM.4.200.000.050	2,0	0	4	10,0	1,9	4	50	4	40°	20°	3,0	▲
DSTM.4.200.000.070	2,0	0	4	14,0	1,9	4	50	4	40°	20°	3,0	▲
DSTM.4.200.010.030	2,0	0,1	4	6,0	1,9	4	50	4	20°	-	-	▲
DSTM.4.200.010.050	2,0	0,1	4	10,0	1,9	4	50	4	40°	20°	3,0	▲
DSTM.4.200.010.070	2,0	0,1	4	14,0	1,9	4	50	4	40°	20°	3,0	▲
DSTM.4.200.020.030	2,0	0,2	4	6,0	1,9	4	50	4	20°	-	-	▲
DSTM.4.200.020.050	2,0	0,2	4	10,0	1,9	4	50	4	40°	20°	3,0	▲
DSTM.4.200.020.070	2,0	0,2	4	14,0	1,9	4	50	4	40°	20°	3,0	▲
DSTM.4.200.050.030	2,0	0,5	4	6,0	1,9	4	50	4	20°	-	-	▲
DSTM.4.200.050.050	2,0	0,5	4	10,0	1,9	4	50	4	40°	20°	3,0	▲
DSTM.4.200.050.070	2,0	0,5	4	14,0	1,9	4	50	4	40°	20°	3,0	▲
DSTM.4.250.000.030	2,5	0	5	7,5	2,4	4	50	4	20°	-	-	▲
DSTM.4.250.000.050	2,5	0	5	12,5	2,4	4	50	4	40°	20°	3,5	▲
DSTM.4.250.000.070	2,5	0	5	17,5	2,4	4	60	4	40°	20°	3,5	▲
DSTM.4.250.010.030	2,5	0,1	5	7,5	2,4	4	50	4	20°	-	-	▲
DSTM.4.250.010.050	2,5	0,1	5	12,5	2,4	4	50	4	40°	20°	3,5	▲
DSTM.4.250.010.070	2,5	0,1	5	17,5	2,4	4	60	4	40°	20°	3,5	▲
DSTM.4.250.020.030	2,5	0,2	5	7,5	2,4	4	50	4	20°	-	-	▲
DSTM.4.250.020.050	2,5	0,2	5	12,5	2,4	4	50	4	40°	20°	3,5	▲
DSTM.4.250.020.070	2,5	0,2	5	17,5	2,4	4	60	4	40°	20°	3,5	▲
DSTM.4.250.050.030	2,5	0,5	5	7,5	2,4	4	50	4	20°	-	-	▲
DSTM.4.250.050.050	2,5	0,5	5	12,5	2,4	4	50	4	40°	20°	3,5	▲
DSTM.4.250.050.070	2,5	0,5	5	17,5	2,4	4	60	4	40°	20°	3,5	▲

▲ ab Lager / on stock Δ 4 Wochen / 4 weeks x auf Anfrage / upon request

● empfohlen / recommended

o bedingt einsetzbar / alternative recommendation

- nicht geeignet / not suitable

■ unbeschichtete HM-Sorten / uncoated grades

■ beschichtete HM-Sorten / coated grades

■ bestückt/Cermet / brazed/Cermet

Abmessungen in mm

Dimensions in mm



P	●
M	○
K	○
N	-
S	○
H	○



HM-Sorten  
Carbide grades

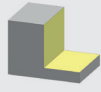

# Schnittdaten DSTM Ø 2 - 2,5 mm

## Cutting Data DSTM Ø 2 - 2,5 mm

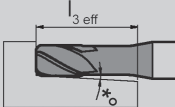

		
	vc = m/min	vc = m/min
P1.1	160	190
P1.2	160	190
P1.3	150	180
P2.1	140	170
P2.2	140	170
P2.3	140	170
P3.1	120	140
P3.2	110	130
M1.1	90	110
M2.1	80	100
M3.1	60	70

		
	vc = m/min	vc = m/min
K1.1	140	170
K1.2	130	160
K2.1	120	140
K2.2	100	120
K3.1	80	100
K3.2	70	80
S1	70	80
S2	55	70
S3	40	50
-	-	-
-	-	-

d <sub>1</sub>												
		0°	0,5°	1°	2°	3°	f <sub>z</sub>	a <sub>e</sub>	a <sub>p</sub>	f <sub>z</sub>	a <sub>e</sub>	a <sub>p</sub>
2,0	4°	6,0	6,3	6,6	7,4	8,5	0,015	0,20	0,40	0,022	0,10	0,20
2,0	4°	10,0	10,2	10,5	11	11,9	0,014	0,20	0,30	0,019	0,10	0,16
2,0	3°	14,0	14,3	14,7	15,4	17,6	0,012	0,20	0,20	0,017	0,10	0,12
2,0	4°	6,0	6,3	6,6	7,4	8,5	0,015	0,20	0,40	0,022	0,10	0,20
2,0	4°	10,0	10,2	10,5	11	11,9	0,014	0,20	0,30	0,019	0,10	0,16
2,0	3°	14,0	14,3	14,7	15,4	17,6	0,012	0,20	0,20	0,017	0,10	0,12
2,0	4°	6,0	6,3	6,6	7,4	8,4	0,015	0,20	0,40	0,022	0,10	0,20
2,0	4°	10,0	10,2	10,4	11	11,8	0,014	0,20	0,30	0,019	0,10	0,16
2,0	3°	14,0	14,3	14,7	15,4	17,5	0,012	0,20	0,20	0,017	0,10	0,12
2,0	4°	6,0	6,2	6,6	7,3	8,3	0,015	0,20	0,40	0,022	0,10	0,20
2,0	4°	10,0	11,7	11	10,4	10,2	0,014	0,20	0,30	0,019	0,10	0,16
2,0	3°	14,0	14,3	14,6	15,4	17,4	0,012	0,20	0,20	0,017	0,10	0,12
2,5	4°	7,5	7,8	8,3	9,3	10,6	0,018	0,25	0,50	0,026	0,13	0,25
2,5	4°	12,5	12,8	13,1	13,8	∞	0,017	0,25	0,38	0,023	0,13	0,20
2,5	3°	17,5	17,9	18,3	19,8	∞	0,015	0,25	0,25	0,021	0,13	0,15
2,5	4°	7,5	7,8	8,3	9,3	10,6	0,018	0,25	0,50	0,026	0,13	0,25
2,5	4°	12,5	12,8	13,1	13,8	∞	0,017	0,25	0,38	0,023	0,13	0,20
2,5	3°	17,5	17,9	18,3	19,8	∞	0,015	0,25	0,25	0,021	0,13	0,15
2,5	4°	7,5	7,8	8,3	9,3	10,5	0,018	0,25	0,50	0,026	0,13	0,25
2,5	4°	12,5	12,8	13,1	13,8	∞	0,017	0,25	0,38	0,023	0,13	0,20
2,5	3°	17,5	17,9	18,3	19,7	∞	0,015	0,25	0,25	0,021	0,13	0,15
2,5	4°	7,5	7,8	8,2	9,2	10,4	0,018	0,25	0,50	0,026	0,13	0,25
2,5	4°	12,5	12,7	13,1	13,7	∞	0,017	0,25	0,38	0,023	0,13	0,20
2,5	3°	17,5	17,9	18,3	19,7	∞	0,015	0,25	0,25	0,021	0,13	0,15

Abmessungen in mm  
Dimensions in mm

B

### DSTM

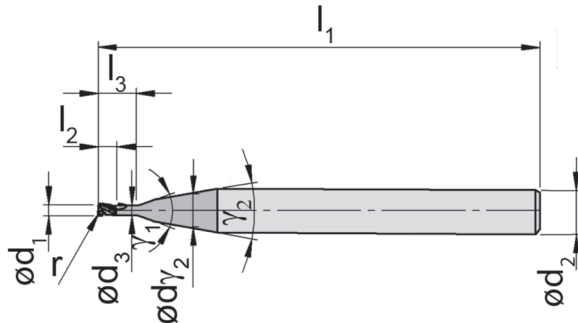
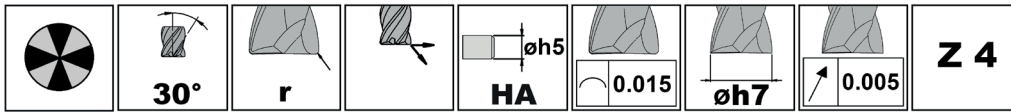

Bis Ø 3 mm vormontiert lieferbar für Toodle Schnelllaufspindel (siehe Seite D2)  
Pre-assembled available up to Ø 3 mm for Toodle high-speed spindle (see page D2)

Bestellnummer Part number	d <sub>1</sub>	r	l <sub>2</sub>	l <sub>3</sub>	d <sub>3</sub>	d <sub>2</sub>	l <sub>1</sub>	Z	γ <sub>1</sub>	γ <sub>2</sub>	d <sub>v2</sub>	TS3K
DSTM.4.300.000.030	3	0	6	9	2,9	4	50	4	20°	-	-	▲
DSTM.4.300.000.050	3	0	6	15	2,9	4	50	4	40°	20°	3,5	▲
DSTM.4.300.000.070	3	0	6	21	2,9	4	60	4	40°	20°	3,5	▲
DSTM.4.300.010.030	3	0,1	6	9	2,9	4	50	4	20°	-	-	▲
DSTM.4.300.010.050	3	0,1	6	15	2,9	4	50	4	40°	20°	3,5	▲
DSTM.4.300.010.070	3	0,1	6	21	2,9	4	60	4	40°	20°	3,5	▲
DSTM.4.300.020.030	3	0,2	6	9	2,9	4	50	4	20°	-	-	▲
DSTM.4.300.020.050	3	0,2	6	15	2,9	4	50	4	40°	20°	3,5	▲
DSTM.4.300.020.070	3	0,2	6	21	2,9	4	60	4	40°	20°	3,5	▲
DSTM.4.300.050.030	3	0,5	6	9	2,9	4	50	4	20°	-	-	▲
DSTM.4.300.050.050	3	0,5	6	15	2,9	4	50	4	40°	20°	3,5	▲
DSTM.4.300.050.070	3	0,5	6	21	2,9	4	60	4	40°	20°	3,5	▲
DSTM.4.300.100.030	3	1,0	6	9	2,9	4	50	4	20°	-	-	▲
DSTM.4.300.100.050	3	1,0	6	15	2,9	4	50	4	40°	20°	3,5	▲
DSTM.4.300.100.070	3	1,0	6	21	2,9	4	60	4	40°	20°	3,5	▲

▲ ab Lager / on stock Δ 4 Wochen / 4 weeks x auf Anfrage / upon request

● empfohlen / recommended

o bedingt einsetzbar / alternative recommendation

- nicht geeignet / not suitable

■ unbeschichtete HM-Sorten / uncoated grades

■ beschichtete HM-Sorten / coated grades

■ bestückt/Cermet / brazed/Cermet

Abmessungen in mm

Dimensions in mm



P	●
M	○
K	○
N	-
S	○
H	○



HM-Sorten  
Carbide grades

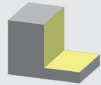

# Schnittdaten DSTM Ø 3 mm

## Cutting Data DSTM Ø 3 mm

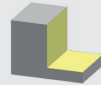

	 $vc = m/min$	 $vc = m/min$
P1.1	160	190
P1.2	160	190
P1.3	150	180
P2.1	140	170
P2.2	140	170
P2.3	140	170
P3.1	120	140
P3.2	110	130
M1.1	90	110
M2.1	80	100
M3.1	60	70

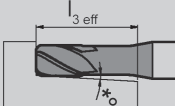
	 $vc = m/min$	 $vc = m/min$
K1.1	140	170
K1.2	130	160
K2.1	120	140
K2.2	100	120
K3.1	80	100
K3.2	70	80
S1	70	80
S2	55	70
S3	40	50
-	-	-
-	-	-

$d_1$	 $\alpha$	 $l_{3\text{eff}}$										
		0°	0,5°	1°	2°	3°	$f_z$	$a_e$	$a_p$	$f_z$	$a_e$	$a_p$
3	4°	9,0	9,4	9,9	11,2	12,7	0,022	0,30	0,60	0,031	0,15	0,30
3	4°	15,0	15,3	15,7	∞	∞	0,019	0,30	0,45	0,028	0,15	0,24
3	3°	21,0	21,5	22,3	∞	∞	0,017	0,30	0,30	0,024	0,15	0,18
3	4°	9,0	9,4	9,9	11,2	12,7	0,022	0,30	0,60	0,031	0,15	0,30
3	4°	15,0	15,3	15,7	∞	∞	0,019	0,30	0,45	0,028	0,15	0,24
3	3°	21,0	21,5	22,3	∞	∞	0,017	0,30	0,30	0,024	0,15	0,18
3	4°	9,0	9,4	9,9	11,1	∞	0,022	0,30	0,60	0,031	0,15	0,30
3	4°	15,0	15,3	15,7	∞	∞	0,019	0,30	0,45	0,028	0,15	0,24
3	3°	21,0	21,5	22,3	∞	∞	0,017	0,30	0,30	0,024	0,15	0,18
3	4°	9,0	9,4	9,9	11,1	∞	0,022	0,30	0,60	0,031	0,15	0,30
3	4°	15,0	15,3	15,7	∞	∞	0,019	0,30	0,45	0,028	0,15	0,24
3	3°	21,0	21,5	22,2	∞	∞	0,017	0,30	0,30	0,024	0,15	0,18
3	4°	9,0	9,4	9,8	10,9	∞	0,022	0,30	0,60	0,031	0,15	0,30
3	4°	15,0	15,3	15,7	∞	∞	0,019	0,30	0,45	0,028	0,15	0,24
3	3°	21,0	21,4	22,2	∞	∞	0,017	0,30	0,30	0,024	0,15	0,18

Abmessungen in mm  
Dimensions in mm



# Schaftfräser Vollradius

Ball Nose End Mill



## DSK

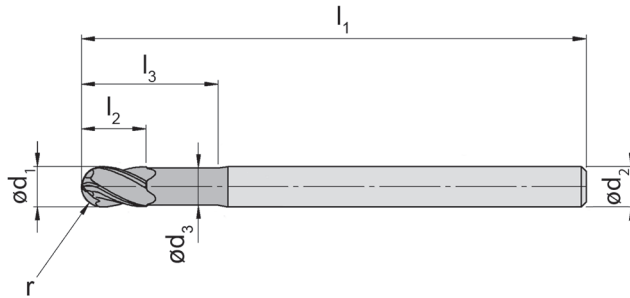
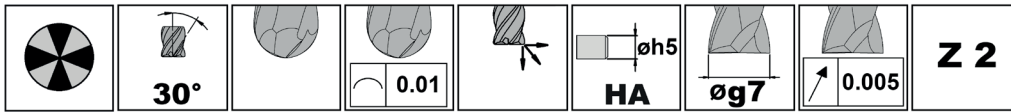

Bestellnummer Part number	d <sub>1</sub>	r	l <sub>2</sub>	l <sub>3</sub>	d <sub>3</sub>	d <sub>2</sub>	l <sub>1</sub>	Z	γ	Ausführung Type	TS3K
DSK.2.035.030	3,5	1,75	7	10,5	3,4	6	64	2	40°	HA	▲
DSK.2.035.050	3,5	1,75	7	17,5	3,4	6	64	2	40°	HA	▲
DSK.2.035.070	3,5	1,75	7	24,5	3,4	6	64	2	40°	HA	▲
DSK.2.040.030	4,0	2,00	8	12,0	3,8	6	64	2	40°	HA	▲
DSK.2.040.050	4,0	2,00	8	20,0	3,8	6	64	2	40°	HA	▲
DSK.2.040.070	4,0	2,00	8	28,0	3,8	6	78	2	40°	HA	▲
DSK.2.050.030	5,0	2,50	10	15,0	4,7	6	64	2	40°	HA	▲
DSK.2.050.050	5,0	2,50	10	25,0	4,7	6	64	2	40°	HA	▲
DSK.2.050.070	5,0	2,50	10	35,0	4,7	6	78	2	40°	HA	▲
DSK.2.060.030	6,0	3,00	12	18,0	5,7	6	64	2	-	HA	▲
DSK.2.060.050	6,0	3,00	12	30,0	5,7	6	78	2	-	HA	▲
DSK.2.060.070	6,0	3,00	12	42,0	5,7	6	100	2	-	HA	▲
DSK.2.080.030	8,0	4,00	16	24,0	7,6	8	64	2	-	HA	▲
DSK.2.080.050	8,0	4,00	16	40,0	7,6	8	100	2	-	HA	▲
DSK.2.080.070	8,0	4,00	16	56,0	7,6	8	100	2	-	HA	▲
DSK.2.100.030	10,0	5,00	20	30,0	9,6	10	78	2	-	HA	▲
DSK.2.100.050	10,0	5,00	20	50,0	9,6	10	100	2	-	HA	▲
DSK.2.100.070	10,0	5,00	20	70,0	9,6	10	120	2	-	HA	▲
DSK.2.120.030	12,0	6,00	24	36,0	11,6	12	100	2	-	HA	▲
DSK.2.120.050	12,0	6,00	24	60,0	11,6	12	120	2	-	HA	▲
DSK.2.120.070	12,0	6,00	24	84,0	11,6	12	140	2	-	HA	▲
DSK.2.160.030	16,0	8,00	32	48,0	15,4	16	100	2	-	HA	▲
DSK.2.160.050	16,0	8,00	32	80,0	15,4	16	140	2	-	HA	▲
DSK.2.160.070	16,0	8,00	32	112,0	15,4	16	163	2	-	HA	▲

▲ ab Lager / on stock Δ 4 Wochen / 4 weeks x auf Anfrage / upon request

● empfohlen / recommended

○ bedingt einsetzbar / alternative recommendation

- nicht geeignet / not suitable

■ unbeschichtete HM-Sorten / uncoated grades

■ beschichtete HM-Sorten / coated grades

■ bestückt/Cermet / brazed/Cermet

Abmessungen in mm

Dimensions in mm



P	●
M	○
K	○
N	-
S	○
H	○



HM-Sorten  
Carbide grades

# Schnittdaten DSK Ø 3,5 - 16 mm

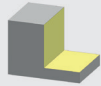

## Cutting Data DSK Ø 3,5 - 16 mm

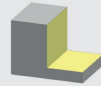

		
	vc = m/min	vc = m/min
P1.1	160	190
P1.2	160	190
P1.3	150	180
P2.1	140	170
P2.2	140	170
P2.3	140	170
P3.1	120	140
P3.2	110	130
M1.1	90	110
M2.1	80	100
M3.1	60	70

		
	vc = m/min	vc = m/min
K1.1	140	170
K1.2	130	160
K2.1	120	140
K2.2	100	120
K3.1	80	100
K3.2	70	80
S1	70	80
S2	55	70
S3	40	50
-	-	-
-	-	-



d <sub>1</sub>							
		f <sub>z</sub>	a <sub>e</sub>	a <sub>p</sub>	f <sub>z</sub>	a <sub>e</sub>	a <sub>p</sub>
3,5	5°	0,03	0,35	0,70	0,04	0,18	0,35
3,5	5°	0,03	0,35	0,70	0,04	0,18	0,35
3,5	5°	0,03	0,35	0,70	0,04	0,18	0,35
4,0	5°	0,03	0,40	0,80	0,04	0,20	0,40
4,0	5°	0,03	0,40	0,80	0,04	0,20	0,40
4,0	5°	0,03	0,50	1,00	0,05	0,25	0,50
5,0	5°	0,03	0,50	1,00	0,05	0,25	0,50
5,0	5°	0,03	0,50	1,00	0,05	0,25	0,50
5,0	5°	0,03	0,50	1,00	0,05	0,25	0,50
6,0	5°	0,04	0,60	1,20	0,06	0,30	0,60
6,0	5°	0,04	0,60	1,20	0,06	0,30	0,60
6,0	5°	0,05	0,80	1,60	0,08	0,40	0,80
8,0	5°	0,05	0,80	1,60	0,08	0,40	0,80
8,0	5°	0,05	0,80	1,60	0,08	0,40	0,80
8,0	5°	0,05	0,80	1,60	0,08	0,40	0,80
10,0	5°	0,07	1,00	2,00	0,09	0,50	1,00
10,0	5°	0,07	1,00	2,00	0,09	0,50	1,00
10,0	5°	0,08	1,20	2,40	0,11	0,60	1,20
12,0	5°	0,08	1,20	2,40	0,11	0,60	1,20
12,0	5°	0,08	1,20	2,40	0,11	0,60	1,20
12,0	5°	0,08	1,20	2,40	0,11	0,60	1,20
16,0	5°	0,10	1,60	3,20	0,15	0,80	1,60
16,0	5°	0,10	1,60	3,20	0,15	0,80	1,60
16,0	5°	0,10	1,60	3,20	0,15	0,80	1,60

Abmessungen in mm  
Dimensions in mm



### DST

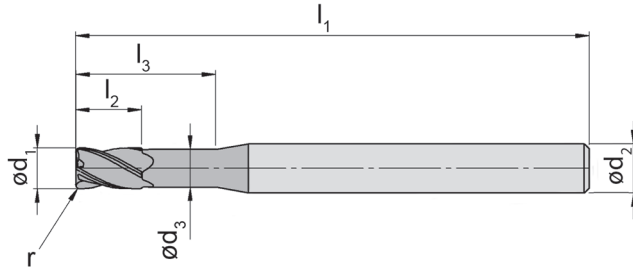
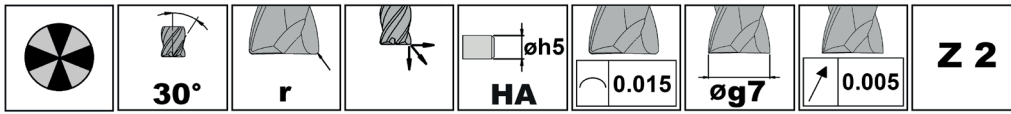

Bestellnummer Part number	d <sub>1</sub>	r	l <sub>2</sub>	l <sub>3</sub>	d <sub>3</sub>	d <sub>2</sub>	l <sub>1</sub>	Z	γ	Ausführung Type	TS3K
DST.2.035.020.030	3,5	0,2	7	10,5	3,4	6	64	2	40°	HA	▲
DST.2.035.020.050	3,5	0,2	7	17,5	3,4	6	64	2	40°	HA	▲
DST.2.035.020.070	3,5	0,2	7	24,5	3,4	6	64	2	40°	HA	▲
DST.2.035.050.030	3,5	0,5	7	10,5	3,4	6	64	2	40°	HA	▲
DST.2.035.050.050	3,5	0,5	7	17,5	3,4	6	64	2	40°	HA	▲
DST.2.035.050.070	3,5	0,5	7	24,5	3,4	6	64	2	40°	HA	▲
DST.2.035.100.030	3,5	1,0	7	10,5	3,4	6	64	2	40°	HA	▲
DST.2.035.100.050	3,5	1,0	7	17,5	3,4	6	64	2	40°	HA	▲
DST.2.035.100.070	3,5	1,0	7	24,5	3,4	6	64	2	40°	HA	▲
DST.2.040.020.030	4,0	0,2	8	12,0	3,8	6	64	2	40°	HA	▲
DST.2.040.020.050	4,0	0,2	8	20,0	3,8	6	64	2	40°	HA	▲
DST.2.040.020.070	4,0	0,2	8	28,0	3,8	6	78	2	40°	HA	▲
DST.2.040.050.030	4,0	0,5	8	12,0	3,8	6	64	2	40°	HA	▲
DST.2.040.050.050	4,0	0,5	8	20,0	3,8	6	64	2	40°	HA	▲
DST.2.040.050.070	4,0	0,5	8	28,0	3,8	6	78	2	40°	HA	▲
DST.2.040.100.030	4,0	1,0	8	12,0	3,8	6	64	2	40°	HA	▲
DST.2.040.100.050	4,0	1,0	8	20,0	3,8	6	64	2	40°	HA	▲
DST.2.040.100.070	4,0	1,0	8	28,0	3,8	6	78	2	40°	HA	▲
DST.2.050.020.030	5,0	0,2	10	15,0	4,7	6	64	2	40°	HA	▲
DST.2.050.020.050	5,0	0,2	10	25,0	4,7	6	64	2	40°	HA	▲
DST.2.050.020.070	5,0	0,2	10	35,0	4,7	6	78	2	40°	HA	▲
DST.2.050.050.030	5,0	0,5	10	15,0	4,7	6	64	2	40°	HA	▲
DST.2.050.050.050	5,0	0,5	10	25,0	4,7	6	64	2	40°	HA	▲
DST.2.050.050.070	5,0	0,5	10	35,0	4,7	6	78	2	40°	HA	▲
DST.2.050.100.030	5,0	1,0	10	15,0	4,7	6	64	2	40°	HA	▲
DST.2.050.100.050	5,0	1,0	10	25,0	4,7	6	64	2	40°	HA	▲
DST.2.050.100.070	5,0	1,0	10	35,0	4,7	6	78	2	40°	HA	▲

▲ ab Lager / on stock Δ 4 Wochen / 4 weeks x auf Anfrage / upon request

● empfohlen / recommended

○ bedingt einsetzbar / alternative recommendation

- nicht geeignet / not suitable

■ unbeschichtete HM-Sorten / uncoated grades

■ beschichtete HM-Sorten / coated grades



■ bestückt/Cermet / brazed/Cermet



P	●
M	○
K	○
N	-
S	○
H	○

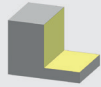

# Schnittdaten DST Ø 3,5 - 5 mm

## Cutting Data DST Ø 3,5 - 5 mm

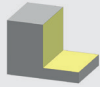

	 $vc = m/min$	 $vc = m/min$
P1.1	160	190
P1.2	160	190
P1.3	150	180
P2.1	140	170
P2.2	140	170
P2.3	140	170
P3.1	120	140
P3.2	110	130
M1.1	90	110
M2.1	80	100
M3.1	60	70

	 $vc = m/min$	 $vc = m/min$
K1.1	140	170
K1.2	130	160
K2.1	120	140
K2.2	100	120
K3.1	80	100
K3.2	70	80
S1	70	80
S2	55	70
S3	40	50
-	-	-
-	-	-

$d_1$	 $\alpha$						
		$f_z$	$a_e$	$a_p$	$f_z$	$a_e$	$a_p$
3,5	5°	0,025	0,35	0,70	0,036	0,18	0,35
3,5	5°	0,025	0,35	0,70	0,036	0,18	0,35
3,5	5°	0,025	0,35	0,70	0,036	0,18	0,35
3,5	5°	0,025	0,35	0,70	0,036	0,18	0,35
3,5	5°	0,025	0,35	0,70	0,036	0,18	0,35
3,5	5°	0,025	0,35	0,70	0,036	0,18	0,35
3,5	5°	0,025	0,35	0,70	0,036	0,18	0,35
3,5	5°	0,025	0,35	0,70	0,036	0,18	0,35
3,5	5°	0,025	0,35	0,70	0,036	0,18	0,35
3,5	5°	0,025	0,35	0,70	0,036	0,18	0,35
4,0	5°	0,028	0,40	0,80	0,040	0,20	0,40
4,0	5°	0,028	0,40	0,80	0,040	0,20	0,40
4,0	5°	0,028	0,40	0,80	0,040	0,20	0,40
4,0	5°	0,028	0,40	0,80	0,040	0,20	0,40
4,0	5°	0,028	0,40	0,80	0,040	0,20	0,40
4,0	5°	0,028	0,40	0,80	0,040	0,20	0,40
4,0	5°	0,028	0,40	0,80	0,040	0,20	0,40
4,0	5°	0,028	0,40	0,80	0,040	0,20	0,40
4,0	5°	0,028	0,40	0,80	0,040	0,20	0,40
4,0	5°	0,028	0,40	0,80	0,040	0,20	0,40
5,0	5°	0,035	0,50	1,00	0,049	0,25	0,50
5,0	5°	0,035	0,50	1,00	0,049	0,25	0,50
5,0	5°	0,035	0,50	1,00	0,049	0,25	0,50
5,0	5°	0,035	0,50	1,00	0,049	0,25	0,50
5,0	5°	0,035	0,50	1,00	0,049	0,25	0,50
5,0	5°	0,035	0,50	1,00	0,049	0,25	0,50
5,0	5°	0,035	0,50	1,00	0,049	0,25	0,50
5,0	5°	0,035	0,50	1,00	0,049	0,25	0,50
5,0	5°	0,035	0,50	1,00	0,049	0,25	0,50
5,0	5°	0,035	0,50	1,00	0,049	0,25	0,50

Abmessungen in mm  
Dimensions in mm

B

### DST

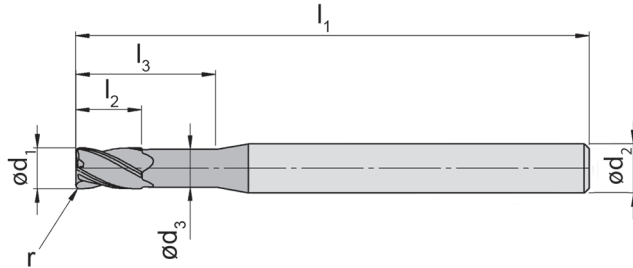
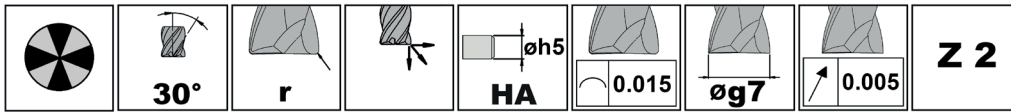

Bestellnummer Part number	d <sub>1</sub>	r	l <sub>2</sub>	l <sub>3</sub>	d <sub>3</sub>	d <sub>2</sub>	l <sub>1</sub>	Z	Ausführung Type	TS3K
DST.2.060.020.030	6	0,2	12	18	5,7	6	64	2	HA	▲
DST.2.060.020.050	6	0,2	12	30	5,7	6	78	2	HA	▲
DST.2.060.020.070	6	0,2	12	42	5,7	6	100	2	HA	▲
DST.2.060.050.030	6	0,5	12	18	5,7	6	64	2	HA	▲
DST.2.060.050.050	6	0,5	12	30	5,7	6	78	2	HA	▲
DST.2.060.050.070	6	0,5	12	42	5,7	6	100	2	HA	▲
DST.2.060.100.030	6	1,0	12	18	5,7	6	64	2	HA	▲
DST.2.060.100.050	6	1,0	12	30	5,7	6	78	2	HA	▲
DST.2.060.100.070	6	1,0	12	42	5,7	6	100	2	HA	▲
DST.2.060.200.030	6	2,0	12	18	5,7	6	64	2	HA	▲
DST.2.060.200.050	6	2,0	12	30	5,7	6	78	2	HA	▲
DST.2.060.200.070	6	2,0	12	42	5,7	6	100	2	HA	▲
DST.2.080.020.030	8	0,2	16	24	7,6	8	64	2	HA	▲
DST.2.080.020.050	8	0,2	16	40	7,6	8	100	2	HA	▲
DST.2.080.020.070	8	0,2	16	56	7,6	8	100	2	HA	▲
DST.2.080.050.030	8	0,5	16	24	7,6	8	64	2	HA	▲
DST.2.080.050.050	8	0,5	16	40	7,6	8	100	2	HA	▲
DST.2.080.050.070	8	0,5	16	56	7,6	8	100	2	HA	▲
DST.2.080.100.030	8	1,0	16	24	7,6	8	64	2	HA	▲
DST.2.080.100.050	8	1,0	16	40	7,6	8	100	2	HA	▲
DST.2.080.100.070	8	1,0	16	56	7,6	8	100	2	HA	▲
DST.2.080.200.030	8	2,0	16	24	7,6	8	64	2	HA	▲
DST.2.080.200.050	8	2,0	16	40	7,6	8	100	2	HA	▲
DST.2.080.200.070	8	2,0	16	56	7,6	8	100	2	HA	▲

▲ ab Lager / on stock Δ 4 Wochen / 4 weeks x auf Anfrage / upon request

● empfohlen / recommended

○ bedingt einsetzbar / alternative recommendation

- nicht geeignet / not suitable

■ unbeschichtete HM-Sorten / uncoated grades

■ beschichtete HM-Sorten / coated grades

■ bestückt/Cermet / brazed/Cermet

Abmessungen in mm

Dimensions in mm

P	•
M	○
K	○
N	-
S	○
H	○

HM-Sorten  
Carbide grades



### DST

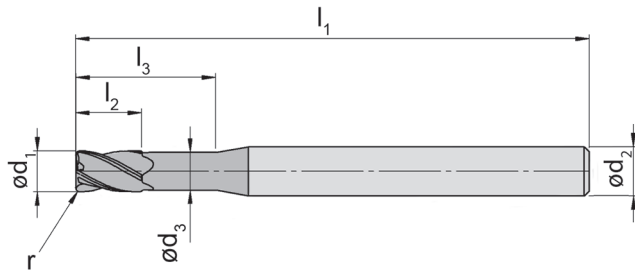
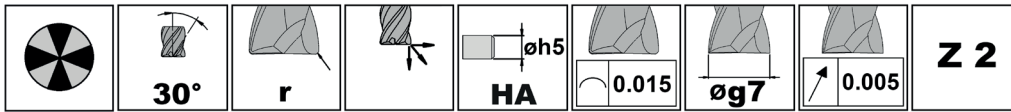

Bestellnummer Part number	d <sub>1</sub>	r	l <sub>2</sub>	l <sub>3</sub>	d <sub>3</sub>	d <sub>2</sub>	l <sub>1</sub>	Z	Ausführung Type	TS3K
DST.2.100.020.030	10	0,2	20	30	9,6	10	78	2	HA	▲
DST.2.100.020.050	10	0,2	20	50	9,6	10	100	2	HA	▲
DST.2.100.020.070	10	0,2	20	70	9,6	10	120	2	HA	▲
DST.2.100.050.030	10	0,5	20	30	9,6	10	78	2	HA	▲
DST.2.100.050.050	10	0,5	20	50	9,6	10	100	2	HA	▲
DST.2.100.050.070	10	0,5	20	70	9,6	10	120	2	HA	▲
DST.2.100.100.030	10	1,0	20	30	9,6	10	78	2	HA	▲
DST.2.100.100.050	10	1,0	20	50	9,6	10	100	2	HA	▲
DST.2.100.100.070	10	1,0	20	70	9,6	10	120	2	HA	▲
DST.2.100.200.030	10	2,0	20	30	9,6	10	78	2	HA	▲
DST.2.100.200.050	10	2,0	20	50	9,6	10	100	2	HA	▲
DST.2.100.200.070	10	2,0	20	70	9,6	10	120	2	HA	▲
DST.2.120.020.030	12	0,2	24	36	11,6	12	100	2	HA	▲
DST.2.120.020.050	12	0,2	24	60	11,6	12	120	2	HA	▲
DST.2.120.020.070	12	0,2	24	84	11,6	12	140	2	HA	▲
DST.2.120.050.030	12	0,5	24	36	11,6	12	100	2	HA	▲
DST.2.120.050.050	12	0,5	24	60	11,6	12	120	2	HA	▲
DST.2.120.050.070	12	0,5	24	84	11,6	12	140	2	HA	▲
DST.2.120.100.030	12	1,0	24	36	11,6	12	100	2	HA	▲
DST.2.120.100.050	12	1,0	24	60	11,6	12	120	2	HA	▲
DST.2.120.100.070	12	1,0	24	84	11,6	12	140	2	HA	▲
DST.2.120.200.030	12	2,0	24	36	11,6	12	100	2	HA	▲
DST.2.120.200.050	12	2,0	24	60	11,6	12	120	2	HA	▲
DST.2.120.200.070	12	2,0	24	84	11,6	12	140	2	HA	▲

▲ ab Lager / on stock   Δ 4 Wochen / 4 weeks   x auf Anfrage / upon request

● empfohlen / recommended

○ bedingt einsetzbar / alternative recommendation

- nicht geeignet / not suitable

■ unbeschichtete HM-Sorten / uncoated grades

■ beschichtete HM-Sorten / coated grades

■ bestückt/Cermet / brazed/Cermet

Abmessungen in mm

Dimensions in mm

P	●
M	○
K	○
N	-
S	○
H	○

HM-Sorten  
Carbide grades



### DST

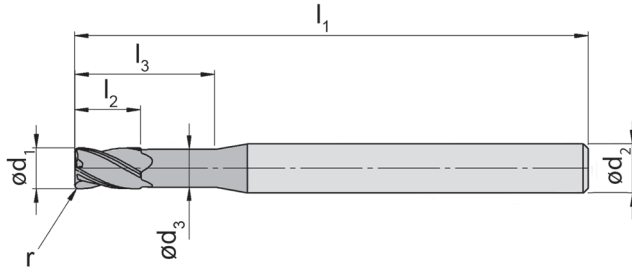
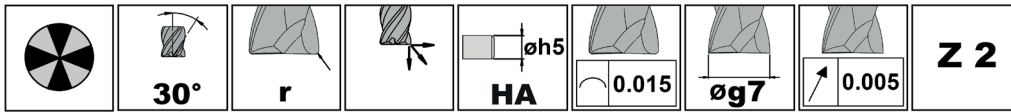

Bestellnummer Part number	d <sub>1</sub>	r	l <sub>2</sub>	l <sub>3</sub>	d <sub>3</sub>	d <sub>2</sub>	l <sub>1</sub>	Z	Ausführung Type	TS3K
DST.2.160.020.030	16	0,2	32	48	15,4	16	100	2	HA	▲
DST.2.160.020.050	16	0,2	32	80	15,4	16	140	2	HA	▲
DST.2.160.020.070	16	0,2	32	112	15,4	16	163	2	HA	▲
DST.2.160.050.030	16	0,5	32	48	15,4	16	100	2	HA	▲
DST.2.160.050.050	16	0,5	32	80	15,4	16	140	2	HA	▲
DST.2.160.050.070	16	0,5	32	112	15,4	16	163	2	HA	▲
DST.2.160.100.030	16	1,0	32	48	15,4	16	100	2	HA	▲
DST.2.160.100.050	16	1,0	32	80	15,4	16	140	2	HA	▲
DST.2.160.100.070	16	1,0	32	112	15,4	16	163	2	HA	▲
DST.2.160.200.030	16	2,0	32	48	15,4	16	100	2	HA	▲
DST.2.160.200.050	16	2,0	32	80	15,4	16	140	2	HA	▲
DST.2.160.200.070	16	2,0	32	112	15,4	16	163	2	HA	▲

▲ ab Lager / on stock Δ 4 Wochen / 4 weeks x auf Anfrage / upon request

● empfohlen / recommended

o bedingt einsetzbar / alternative recommendation

- nicht geeignet / not suitable

■ unbeschichtete HM-Sorten / uncoated grades

■ beschichtete HM-Sorten / coated grades

■ bestückt/Cermet / brazed/Cermet

Abmessungen in mm

Dimensions in mm



P	●
M	○
K	○
N	-
S	○
H	○



HM-Sorten  
Carbide grades

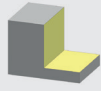

# Schnittdaten DST Ø 16 mm

Cutting Data DST Ø 16 mm

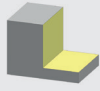

	 $vc = m/min$	 $vc = m/min$
P1.1	160	190
P1.2	160	190
P1.3	150	180
P2.1	140	170
P2.2	140	170
P2.3	140	170
P3.1	120	140
P3.2	110	130
M1.1	90	110
M2.1	80	100
M3.1	60	70

	 $vc = m/min$	 $vc = m/min$
K1.1	140	170
K1.2	130	160
K2.1	120	140
K2.2	100	120
K3.1	80	100
K3.2	70	80
S1	70	80
S2	55	70
S3	40	50
-	-	-
-	-	-

$d_1$	 $\alpha$						
		$f_z$	$a_e$	$a_p$	$f_z$	$a_e$	$a_p$
16	5°	0,104	1,60	3,20	0,147	0,80	1,60
16	5°	0,104	1,60	3,20	0,147	0,80	1,60
16	5°	0,104	1,60	3,20	0,147	0,80	1,60
16	5°	0,104	1,60	3,20	0,147	0,80	1,60
16	5°	0,104	1,60	3,20	0,147	0,80	1,60
16	5°	0,104	1,60	3,20	0,147	0,80	1,60
16	5°	0,104	1,60	3,20	0,147	0,80	1,60
16	5°	0,104	1,60	3,20	0,147	0,80	1,60
16	5°	0,104	1,60	3,20	0,147	0,80	1,60
16	5°	0,104	1,60	3,20	0,147	0,80	1,60
16	5°	0,104	1,60	3,20	0,147	0,80	1,60
16	5°	0,104	1,60	3,20	0,147	0,80	1,60

Abmessungen in mm  
Dimensions in mm





### DST

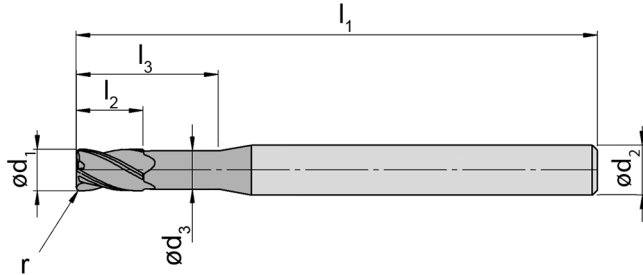
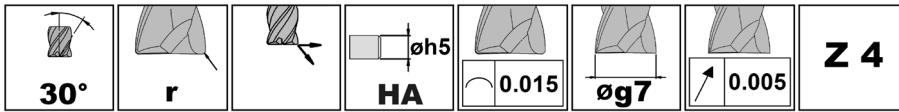

Bestellnummer Part number	d <sub>1</sub>	r	l <sub>2</sub>	l <sub>3</sub>	d <sub>3</sub>	d <sub>2</sub>	l <sub>1</sub>	Z	γ	Ausführung Type	TS3K
DST.4.035.020.030	3,5	0,2	7	10,5	3,4	6	64	4	40°	HA	▲
DST.4.035.020.050	3,5	0,2	7	17,5	3,4	6	64	4	40°	HA	▲
DST.4.035.020.070	3,5	0,2	7	24,5	3,4	6	64	4	40°	HA	▲
DST.4.035.050.030	3,5	0,5	7	10,5	3,4	6	64	4	40°	HA	▲
DST.4.035.050.050	3,5	0,5	7	17,5	3,4	6	64	4	40°	HA	▲
DST.4.035.050.070	3,5	0,5	7	24,5	3,4	6	64	4	40°	HA	▲
DST.4.035.100.030	3,5	1,0	7	10,5	3,4	6	64	4	40°	HA	▲
DST.4.035.100.050	3,5	1,0	7	17,5	3,4	6	64	4	40°	HA	▲
DST.4.035.100.070	3,5	1,0	7	24,5	3,4	6	64	4	40°	HA	▲
DST.4.040.020.030	4,0	0,2	8	12,0	3,8	6	64	4	40°	HA	▲
DST.4.040.020.050	4,0	0,2	8	20,0	3,8	6	64	4	40°	HA	▲
DST.4.040.020.070	4,0	0,2	8	28,0	3,8	6	78	4	40°	HA	▲
DST.4.040.050.030	4,0	0,5	8	12,0	3,8	6	64	4	40°	HA	▲
DST.4.040.050.050	4,0	0,5	8	20,0	3,8	6	64	4	40°	HA	▲
DST.4.040.050.070	4,0	0,5	8	28,0	3,8	6	78	4	40°	HA	▲
DST.4.040.100.030	4,0	1,0	8	12,0	3,8	6	64	4	40°	HA	▲
DST.4.040.100.050	4,0	1,0	8	20,0	3,8	6	64	4	40°	HA	▲
DST.4.040.100.070	4,0	1,0	8	28,0	3,8	6	78	4	40°	HA	▲

▲ ab Lager / on stock Δ 4 Wochen / 4 weeks x auf Anfrage / upon request

● empfohlen / recommended

o bedingt einsetzbar / alternative recommendation

- nicht geeignet / not suitable

■ unbeschichtete HM-Sorten / uncoated grades

■ beschichtete HM-Sorten / coated grades

■ bestückt/Cermet / brazed/Cermet

Abmessungen in mm

Dimensions in mm



P	●
M	○
K	○
N	-
S	○
H	○



HM-Sorten  
Carbide grades

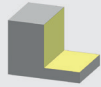

# Schnittdaten DST Ø 3,5 - 4 mm

## Cutting Data DST Ø 3,5 - 4 mm

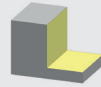

	 $vc = m/min$	 $vc = m/min$
P1.1	160	190
P1.2	160	190
P1.3	150	180
P2.1	140	170
P2.2	140	170
P2.3	140	170
P3.1	120	140
P3.2	110	130
M1.1	90	110
M2.1	80	100
M3.1	60	70

	 $vc = m/min$	 $vc = m/min$
K1.1	140	170
K1.2	130	160
K2.1	120	140
K2.2	100	120
K3.1	80	100
K3.2	70	80
S1	70	80
S2	55	70
S3	40	50
-	-	-
-	-	-

$d_1$	 $\alpha$						
		$f_z$	$a_e$	$a_p$	$f_z$	$a_e$	$a_p$
3,5	4°	0,025	0,35	0,70	0,035	0,18	0,35
3,5	4°	0,025	0,35	0,70	0,035	0,18	0,35
3,5	4°	0,025	0,35	0,70	0,035	0,18	0,35
3,5	4°	0,025	0,35	0,70	0,035	0,18	0,35
3,5	4°	0,025	0,35	0,70	0,035	0,18	0,35
3,5	4°	0,025	0,35	0,70	0,035	0,18	0,35
3,5	4°	0,025	0,35	0,70	0,035	0,18	0,35
3,5	4°	0,025	0,35	0,70	0,035	0,18	0,35
3,5	4°	0,025	0,35	0,70	0,035	0,18	0,35
4,0	4°	0,025	0,35	0,70	0,035	0,18	0,35
4,0	4°	0,028	0,40	0,80	0,040	0,20	0,40
4,0	4°	0,028	0,40	0,80	0,040	0,20	0,40
4,0	4°	0,028	0,40	0,80	0,040	0,20	0,40
4,0	4°	0,028	0,40	0,80	0,040	0,20	0,40
4,0	4°	0,028	0,40	0,80	0,040	0,20	0,40
4,0	4°	0,028	0,40	0,80	0,040	0,20	0,40
4,0	4°	0,028	0,40	0,80	0,040	0,20	0,40
4,0	4°	0,028	0,40	0,80	0,040	0,20	0,40
4,0	4°	0,028	0,40	0,80	0,040	0,20	0,40

Abmessungen in mm  
Dimensions in mm

B

### DST

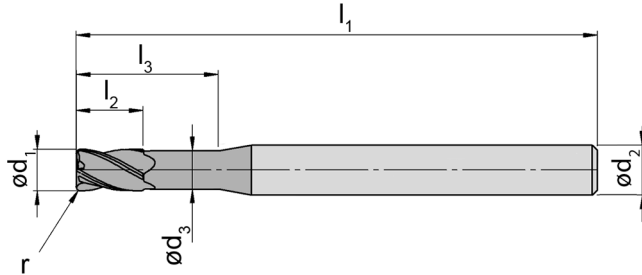
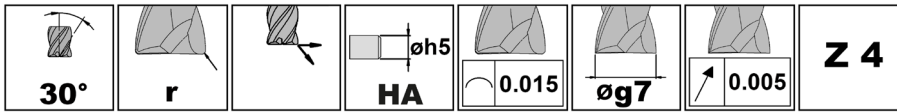

Bestellnummer Part number	d <sub>1</sub>	r	l <sub>2</sub>	l <sub>3</sub>	d <sub>3</sub>	d <sub>2</sub>	l <sub>1</sub>	Z	γ	Ausführung Type	TS3K
DST.4.050.020.030	5	0,2	10	15	4,7	6	64	4	40°	HA	▲
DST.4.050.020.050	5	0,2	10	25	4,7	6	64	4	40°	HA	▲
DST.4.050.020.070	5	0,2	10	35	4,7	6	78	4	40°	HA	▲
DST.4.050.050.030	5	0,5	10	15	4,7	6	64	4	40°	HA	▲
DST.4.050.050.050	5	0,5	10	25	4,7	6	64	4	40°	HA	▲
DST.4.050.050.070	5	0,5	10	35	4,7	6	78	4	40°	HA	▲
DST.4.050.100.030	5	1,0	10	15	4,7	6	64	4	40°	HA	▲
DST.4.050.100.050	5	1,0	10	25	4,7	6	64	4	40°	HA	▲
DST.4.050.100.070	5	1,0	10	35	4,7	6	78	4	40°	HA	▲
DST.4.060.020.030	6	0,2	12	18	5,7	6	64	4	-	HA	▲
DST.4.060.020.050	6	0,2	12	30	5,7	6	78	4	-	HA	▲
DST.4.060.020.070	6	0,2	12	42	5,7	6	100	4	-	HA	▲
DST.4.060.050.030	6	0,5	12	18	5,7	6	64	4	-	HA	▲
DST.4.060.050.050	6	0,5	12	30	5,7	6	78	4	-	HA	▲
DST.4.060.050.070	6	0,5	12	42	5,7	6	100	4	-	HA	▲
DST.4.060.100.030	6	1,0	12	18	5,7	6	64	4	-	HA	▲
DST.4.060.100.050	6	1,0	12	30	5,7	6	78	4	-	HA	▲
DST.4.060.100.070	6	1,0	12	42	5,7	6	100	4	-	HA	▲
DST.4.060.200.030	6	2,0	12	18	5,7	6	64	4	-	HA	▲
DST.4.060.200.050	6	2,0	12	30	5,7	6	78	4	-	HA	▲
DST.4.060.200.070	6	2,0	12	42	5,6	6	100	4	-	HA	▲

▲ ab Lager / on stock Δ 4 Wochen / 4 weeks x auf Anfrage / upon request

● empfohlen / recommended

o bedingt einsetzbar / alternative recommendation

- nicht geeignet / not suitable

■ unbeschichtete HM-Sorten / uncoated grades

■ beschichtete HM-Sorten / coated grades

■ bestückt/Cermet / brazed/Cermet

Abmessungen in mm

Dimensions in mm



P	•
M	◦
K	◦
N	-
S	◦
H	◦



HM-Sorten  
Carbide grades

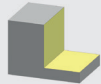

# Schnittdaten DST Ø 5 - 6 mm

## Cutting Data DST Ø 5 - 6 mm



	 $vc = m/min$	 $vc = m/min$
P1.1	160	190
P1.2	160	190
P1.3	150	180
P2.1	140	170
P2.2	140	170
P2.3	140	170
P3.1	120	140
P3.2	110	130
M1.1	90	110
M2.1	80	100
M3.1	60	70

	 $vc = m/min$	 $vc = m/min$
K1.1	140	170
K1.2	130	160
K2.1	120	140
K2.2	100	120
K3.1	80	100
K3.2	70	80
S1	70	80
S2	55	70
S3	40	50
-	-	-
-	-	-

$d_1$							
		$f_z$	$a_e$	$a_p$	$f_z$	$a_e$	$a_p$
5	4°	0,034	0,50	1,00	0,048	0,25	0,50
5	4°	0,034	0,50	1,00	0,048	0,25	0,50
5	4°	0,034	0,50	1,00	0,048	0,25	0,50
5	4°	0,034	0,50	1,00	0,048	0,25	0,50
5	4°	0,034	0,50	1,00	0,048	0,25	0,50
5	4°	0,034	0,50	1,00	0,048	0,25	0,50
5	4°	0,034	0,50	1,00	0,048	0,25	0,50
5	4°	0,034	0,50	1,00	0,048	0,25	0,50
5	4°	0,034	0,50	1,00	0,048	0,25	0,50
5	4°	0,034	0,50	1,00	0,048	0,25	0,50
6	4°	0,041	0,60	1,20	0,057	0,30	0,60
6	4°	0,041	0,60	1,20	0,057	0,30	0,60
6	4°	0,041	0,60	1,20	0,057	0,30	0,60
6	4°	0,041	0,60	1,20	0,057	0,30	0,60
6	4°	0,041	0,60	1,20	0,057	0,30	0,60
6	4°	0,041	0,60	1,20	0,057	0,30	0,60
6	4°	0,041	0,60	1,20	0,057	0,30	0,60
6	4°	0,041	0,60	1,20	0,057	0,30	0,60
6	4°	0,041	0,60	1,20	0,057	0,30	0,60
6	4°	0,041	0,60	1,20	0,057	0,30	0,60
6	4°	0,041	0,60	1,20	0,057	0,30	0,60
6	4°	0,041	0,60	1,20	0,057	0,30	0,60
6	4°	0,041	0,60	1,20	0,057	0,30	0,60
6	4°	0,041	0,60	1,20	0,057	0,30	0,60
6	4°	0,041	0,60	1,20	0,057	0,30	0,60
6	4°	0,041	0,60	1,20	0,057	0,30	0,60

Abmessungen in mm  
Dimensions in mm

B

### DST

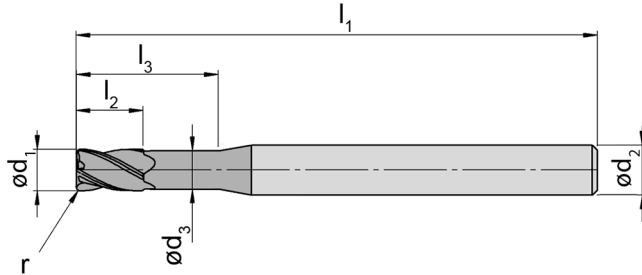
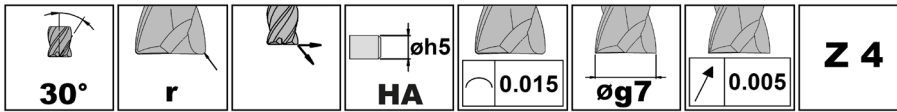

Bestellnummer Part number	d <sub>1</sub>	r	l <sub>2</sub>	l <sub>3</sub>	d <sub>3</sub>	d <sub>2</sub>	l <sub>1</sub>	Z	Ausführung Type	TS3K
DST.4.080.020.030	8	0,2	16	24	7,6	8	64	4	HA	▲
DST.4.080.020.050	8	0,2	16	40	7,6	8	100	4	HA	▲
DST.4.080.020.070	8	0,2	16	56	7,6	8	100	4	HA	▲
DST.4.080.050.030	8	0,5	16	24	7,6	8	64	4	HA	▲
DST.4.080.050.050	8	0,5	16	40	7,6	8	100	4	HA	▲
DST.4.080.050.070	8	0,5	16	56	7,6	8	100	4	HA	▲
DST.4.080.100.030	8	1,0	16	24	7,6	8	64	4	HA	▲
DST.4.080.100.050	8	1,0	16	40	7,6	8	100	4	HA	▲
DST.4.080.100.070	8	1,0	16	56	7,6	8	100	4	HA	▲
DST.4.080.200.030	8	2,0	16	24	7,6	8	64	4	HA	▲
DST.4.080.200.050	8	2,0	16	40	7,6	8	100	4	HA	▲
DST.4.080.200.070	8	2,0	16	56	7,6	8	100	4	HA	▲
DST.4.100.020.030	10	0,2	20	30	9,6	10	78	4	HA	▲
DST.4.100.020.050	10	0,2	20	50	9,6	10	100	4	HA	▲
DST.4.100.020.070	10	0,2	20	70	9,6	10	120	4	HA	▲
DST.4.100.050.030	10	0,5	20	30	9,6	10	78	4	HA	▲
DST.4.100.050.050	10	0,5	20	50	9,6	10	100	4	HA	▲
DST.4.100.050.070	10	0,5	20	70	9,6	10	120	4	HA	▲
DST.4.100.100.030	10	1,0	20	30	9,6	10	78	4	HA	▲
DST.4.100.100.050	10	1,0	20	50	9,6	10	100	4	HA	▲
DST.4.100.100.070	10	1,0	20	70	9,6	10	120	4	HA	▲
DST.4.100.200.030	10	2,0	20	30	9,6	10	78	4	HA	▲
DST.4.100.200.050	10	2,0	20	50	9,6	10	100	4	HA	▲
DST.4.100.200.070	10	2,0	20	70	9,6	10	120	4	HA	▲

▲ ab Lager / on stock Δ 4 Wochen / 4 weeks x auf Anfrage / upon request

● empfohlen / recommended

○ bedingt einsetzbar / alternative recommendation

- nicht geeignet / not suitable

■ unbeschichtete HM-Sorten / uncoated grades

■ beschichtete HM-Sorten / coated grades

■ bestückt/Cermet / brazed/Cermet

Abmessungen in mm

Dimensions in mm

P	•
M	○
K	○
N	-
S	○
H	○

HM-Sorten  
Carbide grades



### DST

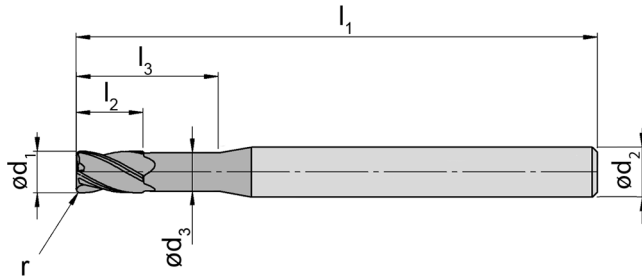
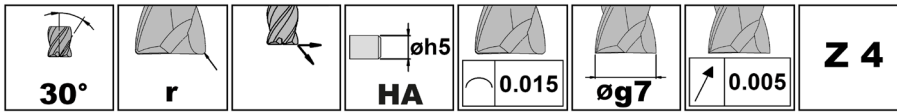

Bestellnummer Part number	d <sub>1</sub>	r	l <sub>2</sub>	l <sub>3</sub>	d <sub>3</sub>	d <sub>2</sub>	l <sub>1</sub>	Z	Ausführung Type	TS3K
DST.4.120.020.030	12	0,2	24	36	11,6	12	100	4	HA	▲
DST.4.120.020.050	12	0,2	24	60	11,6	12	120	4	HA	▲
DST.4.120.020.070	12	0,2	24	84	11,6	12	140	4	HA	▲
DST.4.120.050.030	12	0,5	24	36	11,6	12	100	4	HA	▲
DST.4.120.050.050	12	0,5	24	60	11,6	12	120	4	HA	▲
DST.4.120.050.070	12	0,5	24	84	11,6	12	140	4	HA	▲
DST.4.120.100.030	12	1,0	24	36	11,6	12	100	4	HA	▲
DST.4.120.100.050	12	1,0	24	60	11,6	12	120	4	HA	▲
DST.4.120.100.070	12	1,0	24	84	11,6	12	140	4	HA	▲
DST.4.120.200.030	12	2,0	24	36	11,6	12	100	4	HA	▲
DST.4.120.200.050	12	2,0	24	60	11,6	12	120	4	HA	▲
DST.4.120.200.070	12	2,0	24	84	11,6	12	140	4	HA	▲
DST.4.160.020.030	16	0,2	32	48	15,4	16	100	4	HA	▲
DST.4.160.020.050	16	0,2	32	80	15,4	16	140	4	HA	▲
DST.4.160.020.070	16	0,2	32	112	15,4	16	163	4	HA	▲
DST.4.160.050.030	16	0,5	32	48	15,4	16	100	4	HA	▲
DST.4.160.050.050	16	0,5	32	80	15,4	16	140	4	HA	▲
DST.4.160.050.070	16	0,5	32	112	15,4	16	163	4	HA	▲
DST.4.160.100.030	16	1,0	32	48	15,4	16	100	4	HA	▲
DST.4.160.100.050	16	1,0	32	80	15,4	16	140	4	HA	▲
DST.4.160.100.070	16	1,0	32	112	15,4	16	163	4	HA	▲
DST.4.160.200.030	16	2,0	32	48	15,4	16	100	4	HA	▲
DST.4.160.200.050	16	2,0	32	80	15,4	16	140	4	HA	▲
DST.4.160.200.070	16	2,0	32	112	15,4	16	163	4	HA	▲

▲ ab Lager / on stock Δ 4 Wochen / 4 weeks x auf Anfrage / upon request

● empfohlen / recommended

○ bedingt einsetzbar / alternative recommendation

- nicht geeignet / not suitable

■ unbeschichtete HM-Sorten / uncoated grades

■ beschichtete HM-Sorten / coated grades

■ bestückt/Cermet / brazed/Cermet

Abmessungen in mm

Dimensions in mm

P	•
M	○
K	○
N	-
S	○
H	○

HM-Sorten  
Carbide grades





# Schaftfräser Mehrschneider

## End Mill multiple fluted



### DSM

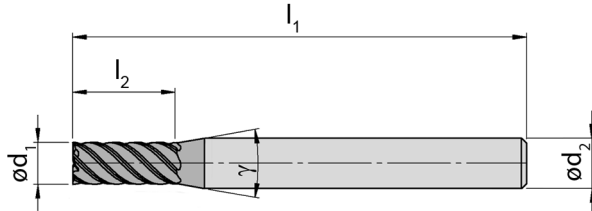
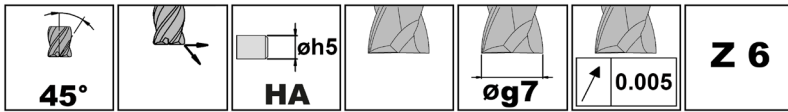

Bis Ø 3 mm vormontiert lieferbar für Toodle Schnellaufspindel (siehe Seite D2)  
Pre-assembled available up to Ø 3 mm for Toodle high-speed spindle (see page D2)

Bestellnummer Part number	d <sub>1</sub>	l <sub>2</sub>	d <sub>2</sub>	l <sub>1</sub>	Z	γ	TS3K
DSM.6.020.20	2	4	6	57	6	40°	▲
DSM.6.020.30	2	6	6	57	6	40°	▲
DSM.6.020.40	2	8	6	57	6	40°	▲
DSM.6.030.20	3	6	6	57	6	40°	▲
DSM.6.030.30	3	9	6	57	6	40°	▲
DSM.6.030.40	3	12	6	57	6	40°	▲
DSM.6.040.20	4	8	6	57	6	40°	▲
DSM.6.040.30	4	12	6	57	6	40°	▲
DSM.6.040.40	4	16	6	57	6	40°	▲
DSM.6.050.20	5	10	6	57	6	40°	▲
DSM.6.050.30	5	15	6	57	6	40°	▲
DSM.6.050.40	5	20	6	57	6	40°	▲
DSM.6.060.20	6	12	6	50	6	-	▲
DSM.6.060.30	6	18	6	57	6	-	▲
DSM.6.060.40	6	24	6	64	6	-	▲

▲ ab Lager / on stock Δ 4 Wochen / 4 weeks x auf Anfrage / upon request

● empfohlen / recommended

o bedingt einsetzbar / alternative recommendation

- nicht geeignet / not suitable

■ unbeschichtete HM-Sorten / uncoated grades

■ beschichtete HM-Sorten / coated grades

■ bestückt/Cermet / brazed/Cermet

Abmessungen in mm

Dimensions in mm



P	●
M	○
K	○
N	-
S	○
H	○



HM-Sorten  
Carbide grades

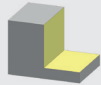

# Schnittdaten DSM Ø 2 - 6 mm

## Cutting Data DSM Ø 2 - 6 mm

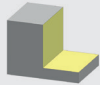

	 $vc = m/min$	 $vc = m/min$
P1.1	140	170
P1.2	140	170
P1.3	130	160
P2.1	120	140
P2.2	120	140
P2.3	120	140
P3.1	100	120
P3.2	90	110
M1.1	80	100
M2.1	60	70
M3.1	45	50

	 $vc = m/min$	 $vc = m/min$
K1.1	120	140
K1.2	100	120
K2.1	100	120
K2.2	80	100
K3.1	70	80
K3.2	60	70
S1	55	70
S2	40	50
S3	35	40
-	-	-
-	-	-

$d_1$	 $\alpha$						
		$f_z$	$a_e$	$a_p$	$f_z$	$a_e$	$a_p$
2	2°	0,007	0,20	4,00	0,004	0,06	4,00
2	2°	0,007	0,20	4,00	0,004	0,06	4,00
2	2°	0,007	0,20	4,00	0,004	0,06	4,00
3	2°	0,011	0,30	6,00	0,011	0,09	6,00
3	2°	0,011	0,30	6,00	0,011	0,09	6,00
3	2°	0,011	0,30	6,00	0,011	0,09	6,00
4	2°	0,015	0,40	8,00	0,017	0,12	8,00
4	2°	0,015	0,40	8,00	0,017	0,12	8,00
4	2°	0,008	0,40	8,00	0,017	0,12	8,00
5	2°	0,012	0,50	10,00	0,024	0,15	10,00
5	2°	0,012	0,50	10,00	0,024	0,15	10,00
5	2°	0,012	0,50	10,00	0,024	0,15	10,00
6	2°	0,016	0,60	12,00	0,030	0,18	12,00
6	2°	0,016	0,60	12,00	0,030	0,18	12,00
6	2°	0,016	0,60	12,00	0,030	0,18	12,00

Abmessungen in mm  
Dimensions in mm

B

# Schaftfräser Mehrschneider

## End Mill multiple fluted



### DSM

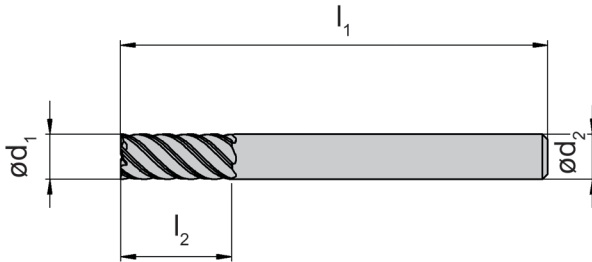
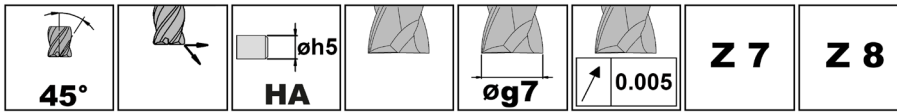

Bestellnummer Part number	d <sub>1</sub>	l <sub>2</sub>	d <sub>2</sub>	l <sub>1</sub>	Z	TS3K
DSM.7.080.20	8	16	8	54	7	▲
DSM.7.080.30	8	24	8	64	7	▲
DSM.7.080.40	8	32	8	78	7	▲
DSM.7.100.20	10	20	10	60	7	▲
DSM.7.100.30	10	30	10	70	7	▲
DSM.7.100.40	10	40	10	89	7	▲
DSM.7.120.20	12	24	12	78	7	▲
DSM.7.120.30	12	36	12	83	7	▲
DSM.7.120.40	12	48	12	100	7	▲
DSM.8.160.20	16	32	16	89	8	▲
DSM.8.160.30	16	48	16	100	8	▲
DSM.8.160.40	16	64	16	120	8	▲
DSM.8.200.20	20	40	20	102	8	▲
DSM.8.200.30	20	60	20	125	8	▲
DSM.8.200.40	20	80	20	150	8	▲

▲ ab Lager / on stock Δ 4 Wochen / 4 weeks x auf Anfrage / upon request

● empfohlen / recommended

o bedingt einsetzbar / alternative recommendation

- nicht geeignet / not suitable

■ unbeschichtete HM-Sorten / uncoated grades

■ beschichtete HM-Sorten / coated grades

■ bestückt/Cermet / brazed/Cermet

Abmessungen in mm

Dimensions in mm



P	•
M	◦
K	◦
N	-
S	◦
H	◦



HM-Sorten  
Carbide grades

# Schnittdaten DSM Ø 8 - 20 mm

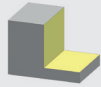

## Cutting Data DSM Ø 8 - 20 mm

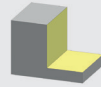

	 $vc = m/min$	 $vc = m/min$
P1.1	140	170
P1.2	140	170
P1.3	130	160
P2.1	120	140
P2.2	120	140
P2.3	120	140
P3.1	100	120
P3.2	90	110
M1.1	80	100
M2.1	60	70
M3.1	45	50

	 $vc = m/min$	 $vc = m/min$
K1.1	120	140
K1.2	100	120
K2.1	100	120
K2.2	80	100
K3.1	70	80
K3.2	60	70
S1	55	70
S2	40	50
S3	35	40
-	-	-
-	-	-

**B**

$d_1$	 $\alpha$						
		$f_z$	$a_e$	$a_p$	$f_z$	$a_e$	$a_p$
8	2°	0,019	0,80	16,00	0,038	0,24	16,00
8	2°	0,019	0,80	16,00	0,038	0,24	16,00
8	2°	0,019	0,80	16,00	0,038	0,24	16,00
10	2°	0,027	1,00	20,00	0,050	0,30	20,00
10	2°	0,027	1,00	20,00	0,050	0,30	20,00
10	2°	0,027	1,00	20,00	0,050	0,30	20,00
12	2°	0,035	1,20	24,00	0,063	0,36	24,00
12	2°	0,035	1,20	24,00	0,063	0,36	24,00
12	2°	0,035	1,20	24,00	0,063	0,36	24,00
16	2°	0,047	1,60	32,00	0,085	0,48	32,00
16	2°	0,047	1,60	32,00	0,085	0,48	32,00
16	2°	0,047	1,60	32,00	0,085	0,48	32,00
20	2°	0,062	2,00	40,00	0,110	0,60	40,00
20	2°	0,062	2,00	40,00	0,110	0,60	40,00
20	2°	0,062	2,00	40,00	0,110	0,60	40,00

Abmessungen in mm  
Dimensions in mm

# Schaftfräser Mehrschneider, Eckenradius

## End Mill multiple fluted, corner radius



### DSMR

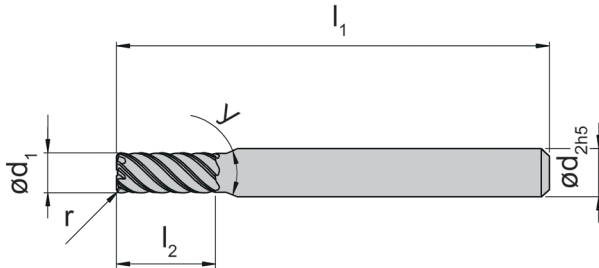
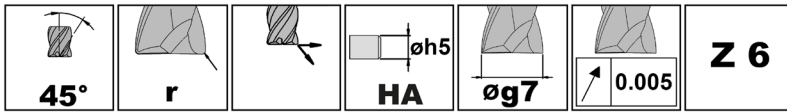

Bis Ø 3 mm vormontiert lieferbar für Toodle Schnelllaufspindel (siehe Seite D2)  
Pre-assembled available up to Ø 3 mm for Toodle high-speed spindle (see page D2)

Bestellnummer Part number	d <sub>1</sub>	r	l <sub>2</sub>	d <sub>2</sub>	l <sub>1</sub>	Z	γ	TS3K
DSMR.6.020.020.20	2	0,2	4	6	57	6	40°	▲
DSMR.6.020.020.30	2	0,2	6	6	57	6	40°	▲
DSMR.6.020.020.40	2	0,2	8	6	57	6	40°	▲
DSMR.6.030.020.20	3	0,2	6	6	57	6	40°	▲
DSMR.6.030.020.30	3	0,2	9	6	57	6	40°	▲
DSMR.6.030.020.40	3	0,2	12	6	57	6	40°	▲
DSMR.6.030.050.20	3	0,5	6	6	57	6	40°	▲
DSMR.6.030.050.30	3	0,5	9	6	57	6	40°	▲
DSMR.6.030.050.40	3	0,5	12	6	57	6	40°	▲
DSMR.6.040.020.20	4	0,2	8	6	57	6	40°	▲
DSMR.6.040.020.30	4	0,2	12	6	57	6	40°	▲
DSMR.6.040.020.40	4	0,2	16	6	57	6	40°	▲
DSMR.6.040.050.20	4	0,5	8	6	57	6	40°	▲
DSMR.6.040.050.30	4	0,5	12	6	57	6	40°	▲
DSMR.6.040.050.40	4	0,5	20	6	57	6	40°	▲
DSMR.6.050.020.20	5	0,2	10	6	57	6	40°	▲
DSMR.6.050.020.30	5	0,2	15	6	57	6	40°	▲
DSMR.6.050.020.40	5	0,2	20	6	57	6	40°	▲
DSMR.6.050.050.20	5	0,5	10	6	57	6	40°	▲
DSMR.6.050.050.30	5	0,5	15	6	57	6	40°	▲
DSMR.6.050.050.40	5	0,5	20	6	57	6	40°	▲

▲ ab Lager / on stock Δ 4 Wochen / 4 weeks x auf Anfrage / upon request

● empfohlen / recommended

o bedingt einsetzbar / alternative recommendation

- nicht geeignet / not suitable

■ unbeschichtete HM-Sorten / uncoated grades

■ beschichtete HM-Sorten / coated grades

■ bestückt/Cermet / brazed/Cermet

Abmessungen in mm

Dimensions in mm

P	•
M	◦
K	◦
N	-
S	◦
H	◦

HM-Sorten  
Carbide grades



# Schnittdaten DSMR Ø 2 - 5 mm

## Cutting Data DSM Ø 2 - 5 mm

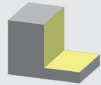
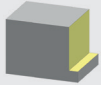

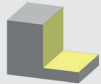
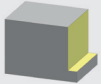
	 $vc = m/min$	 $vc = m/min$
P1.1	140	170
P1.2	140	170
P1.3	130	160
P2.1	120	140
P2.2	120	140
P2.3	120	140
P3.1	100	120
P3.2	90	110
M1.1	80	100
M2.1	60	70
M3.1	45	50

	 $vc = m/min$	 $vc = m/min$
K1.1	120	140
K1.2	100	120
K2.1	100	120
K2.2	80	100
K3.1	70	80
K3.2	60	70
S1	55	70
S2	40	50
S3	35	40
-	-	-
-	-	-

$d_1$							
		$f_z$	$a_e$	$a_p$	$f_z$	$a_e$	$a_p$
2	3°	0,000	0,20	4,00	0,004	0,06	4,00
2	3°	0,000	0,20	4,00	0,004	0,06	4,00
2	3°	0,000	0,20	4,00	0,004	0,06	4,00
3	3°	0,004	0,30	6,00	0,011	0,09	6,00
3	3°	0,004	0,30	6,00	0,011	0,09	6,00
3	3°	0,004	0,30	6,00	0,011	0,09	6,00
3	3°	0,004	0,30	6,00	0,011	0,09	6,00
3	3°	0,004	0,30	6,00	0,011	0,09	6,00
3	3°	0,004	0,30	6,00	0,011	0,09	6,00
4	3°	0,008	0,40	8,00	0,017	0,12	8,00
4	3°	0,008	0,40	8,00	0,017	0,12	8,00
4	3°	0,008	0,40	8,00	0,017	0,12	8,00
4	3°	0,008	0,40	8,00	0,017	0,12	8,00
4	3°	0,008	0,40	8,00	0,017	0,12	8,00
4	3°	0,008	0,40	8,00	0,017	0,12	8,00
5	3°	0,012	0,50	10,00	0,024	0,15	10,00
5	3°	0,012	0,50	10,00	0,024	0,15	10,00
5	3°	0,012	0,50	10,00	0,024	0,15	10,00
5	3°	0,012	0,50	10,00	0,024	0,15	10,00
5	3°	0,012	0,50	10,00	0,024	0,15	10,00
5	3°	0,012	0,50	10,00	0,024	0,15	10,00

Abmessungen in mm  
Dimensions in mm

B

# Schaftfräser Mehrschneider, Eckenradius

## End Mill multiple fluted, corner radius



### DSMR

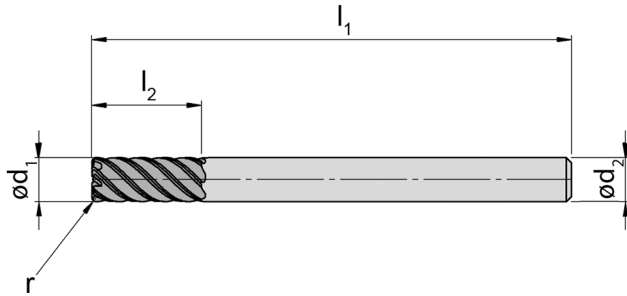
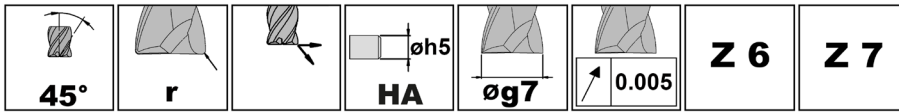

Bestellnummer Part number	d <sub>1</sub>	r	l <sub>2</sub>	d <sub>2</sub>	l <sub>1</sub>	Z	TS3K
DSMR.6.060.020.20	6	0,2	12	6	50	6	▲
DSMR.6.060.020.30	6	0,2	18	6	57	6	▲
DSMR.6.060.020.40	6	0,2	24	6	64	6	▲
DSMR.6.060.050.20	6	0,5	12	6	50	6	▲
DSMR.6.060.050.30	6	0,5	18	6	57	6	▲
DSMR.6.060.050.40	6	0,5	24	6	64	6	▲
DSMR.6.060.100.20	6	1,0	12	6	50	6	▲
DSMR.6.060.100.30	6	1,0	18	6	57	6	▲
DSMR.6.060.100.40	6	1,0	24	6	64	6	▲
DSMR.7.080.020.20	8	0,2	16	8	54	7	▲
DSMR.7.080.020.30	8	0,2	24	8	64	7	▲
DSMR.7.080.020.40	8	0,2	32	8	78	7	▲
DSMR.7.080.050.20	8	0,5	16	8	54	7	▲
DSMR.7.080.050.30	8	0,5	24	8	64	7	▲
DSMR.7.080.050.40	8	0,5	32	8	78	7	▲
DSMR.7.080.100.20	8	1,0	16	8	54	7	▲
DSMR.7.080.100.30	8	1,0	24	8	64	7	▲
DSMR.7.080.100.40	8	1,0	32	8	78	7	▲

▲ ab Lager / on stock Δ 4 Wochen / 4 weeks x auf Anfrage / upon request

● empfohlen / recommended

o bedingt einsetzbar / alternative recommendation

- nicht geeignet / not suitable

■ unbeschichtete HM-Sorten / uncoated grades

■ beschichtete HM-Sorten / coated grades

■ bestückt/Cermet / brazed/Cermet

Abmessungen in mm

Dimensions in mm

P	●
M	○
K	○
N	-
S	○
H	○

HM-Sorten  
Carbide grades



# Schnittdaten DSMR Ø 6 - 8 mm

## Cutting Data DSMR Ø 6 - 8 mm

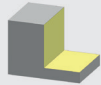
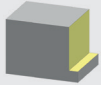

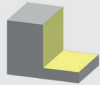
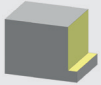
	 $vc = m/min$	 $vc = m/min$
P1.1	140	170
P1.2	140	170
P1.3	130	160
P2.1	120	140
P2.2	120	140
P2.3	120	140
P3.1	100	120
P3.2	90	110
M1.1	80	100
M2.1	60	70
M3.1	45	50

	 $vc = m/min$	 $vc = m/min$
K1.1	120	140
K1.2	100	120
K2.1	100	120
K2.2	80	100
K3.1	70	80
K3.2	60	70
S1	55	70
S2	40	50
S3	35	40
-	-	-
-	-	-

$d_1$	 $\alpha$						
		$f_z$	$a_e$	$a_p$	$f_z$	$a_e$	$a_p$
6	3°	0,016	0,60	12,00	0,030	0,18	12,00
6	3°	0,016	0,60	12,00	0,030	0,18	12,00
6	3°	0,016	0,60	12,00	0,030	0,18	12,00
6	3°	0,016	0,60	12,00	0,030	0,18	12,00
6	3°	0,016	0,60	12,00	0,030	0,18	12,00
6	3°	0,016	0,60	12,00	0,030	0,18	12,00
6	3°	0,016	0,60	12,00	0,030	0,18	12,00
6	3°	0,016	0,60	12,00	0,030	0,18	12,00
6	3°	0,016	0,60	12,00	0,030	0,18	12,00
6	3°	0,016	0,60	12,00	0,030	0,18	12,00
8	3°	0,019	0,80	16,00	0,038	0,24	16,00
8	3°	0,019	0,80	16,00	0,038	0,24	16,00
8	3°	0,019	0,80	16,00	0,038	0,24	16,00
8	3°	0,019	0,80	16,00	0,038	0,24	16,00
8	3°	0,019	0,80	16,00	0,038	0,24	16,00
8	3°	0,019	0,80	16,00	0,038	0,24	16,00
8	3°	0,019	0,80	16,00	0,038	0,24	16,00
8	3°	0,019	0,80	16,00	0,038	0,24	16,00
8	3°	0,019	0,80	16,00	0,038	0,24	16,00
8	3°	0,019	0,80	16,00	0,038	0,24	16,00

Abmessungen in mm  
Dimensions in mm





# Schaftfräser Mehrschneider, Eckenradius

## End Mill multiple fluted, corner radius



### DSMR

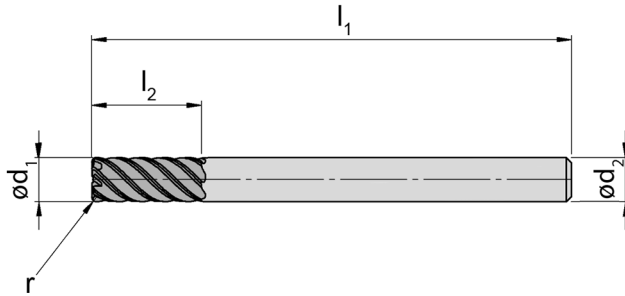
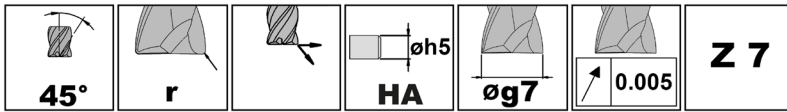

Bestellnummer Part number	d <sub>1</sub>	r	l <sub>2</sub>	d <sub>2</sub>	l <sub>1</sub>	Z	TS3K
DSMR.7.100.020.20	10	0,2	20	10	60	7	▲
DSMR.7.100.020.30	10	0,2	30	10	70	7	▲
DSMR.7.100.020.40	10	0,2	40	10	89	7	▲
DSMR.7.100.050.20	10	0,5	20	10	60	7	▲
DSMR.7.100.050.30	10	0,5	30	10	70	7	▲
DSMR.7.100.050.40	10	0,5	40	10	89	7	▲
DSMR.7.100.100.20	10	1,0	20	10	60	7	▲
DSMR.7.100.100.30	10	1,0	30	10	70	7	▲
DSMR.7.100.100.40	10	1,0	40	10	89	7	▲
DSMR.7.120.020.20	12	0,2	24	12	70	7	▲
DSMR.7.120.020.30	12	0,2	36	12	83	7	▲
DSMR.7.120.020.40	12	0,2	48	12	100	7	▲
DSMR.7.120.050.20	12	0,5	24	12	70	7	▲
DSMR.7.120.050.30	12	0,5	36	12	83	7	▲
DSMR.7.120.050.40	12	0,5	48	12	100	7	▲
DSMR.7.120.100.20	12	1,0	24	12	70	7	▲
DSMR.7.120.100.30	12	1,0	36	12	83	7	▲
DSMR.7.120.100.40	12	1,0	48	12	100	7	▲

▲ ab Lager / on stock Δ 4 Wochen / 4 weeks x auf Anfrage / upon request

● empfohlen / recommended

o bedingt einsetzbar / alternative recommendation

- nicht geeignet / not suitable

■ unbeschichtete HM-Sorten / uncoated grades

■ beschichtete HM-Sorten / coated grades

■ bestückt/Cermet / brazed/Cermet

Abmessungen in mm

Dimensions in mm



P	●
M	○
K	○
N	-
S	○
H	○



HM-Sorten  
Carbide grades

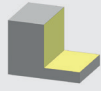

# Schnittdaten DSMR Ø 10 - 12 mm

## Cutting Data DSMR Ø 10 - 12 mm

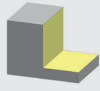

	 vc = m/min	 vc = m/min
P1.1	140	170
P1.2	140	170
P1.3	130	160
P2.1	120	140
P2.2	120	140
P2.3	120	140
P3.1	100	120
P3.2	90	110
M1.1	80	100
M2.1	60	70
M3.1	45	50

	 vc = m/min	 vc = m/min
K1.1	120	140
K1.2	100	120
K2.1	100	120
K2.2	80	100
K3.1	70	80
K3.2	60	70
S1	55	70
S2	40	50
S3	35	40
-	-	-
-	-	-

d <sub>1</sub>	 α						
		f <sub>z</sub>	a <sub>e</sub>	a <sub>p</sub>	f <sub>z</sub>	a <sub>e</sub>	a <sub>p</sub>
10	3°	0,027	1,00	20,00	0,050	0,30	20,00
10	3°	0,027	1,00	20,00	0,050	0,30	20,00
10	3°	0,027	1,00	20,00	0,050	0,30	20,00
10	3°	0,027	1,00	20,00	0,050	0,30	20,00
10	3°	0,027	1,00	20,00	0,050	0,30	20,00
10	3°	0,027	1,00	20,00	0,050	0,30	20,00
10	3°	0,027	1,00	20,00	0,050	0,30	20,00
10	3°	0,027	1,00	20,00	0,050	0,30	20,00
10	3°	0,027	1,00	20,00	0,050	0,30	20,00
10	3°	0,027	1,00	20,00	0,050	0,30	20,00
12	3°	0,035	1,20	24,00	0,063	0,36	24,00
12	3°	0,035	1,20	36,00	0,063	0,36	36,00
12	3°	0,035	1,20	48,00	0,063	0,36	48,00
12	3°	0,035	1,20	24,00	0,063	0,36	24,00
12	3°	0,035	1,20	36,00	0,063	0,36	36,00
12	3°	0,035	1,20	48,00	0,063	0,36	48,00
12	3°	0,035	1,20	24,00	0,063	0,36	24,00
12	3°	0,035	1,20	36,00	0,063	0,36	36,00
12	3°	0,035	1,20	48,00	0,063	0,36	48,00

Abmessungen in mm  
Dimensions in mm

B

# Schaftfräser Mehrschneider, Eckenradius

## End Mill multiple fluted, corner radius



### DSMR

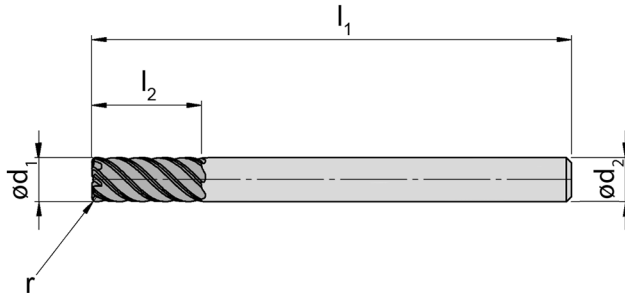
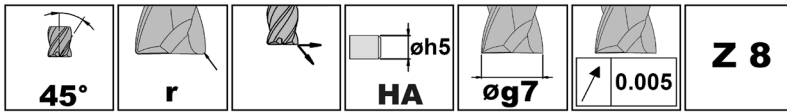

Bestellnummer Part number	d <sub>1</sub>	r	l <sub>2</sub>	d <sub>2</sub>	l <sub>1</sub>	Z	TS3K
DSMR.8.160.020.20	16	0,2	32	16	89	8	▲
DSMR.8.160.020.30	16	0,2	48	16	100	8	▲
DSMR.8.160.020.40	16	0,2	64	16	120	8	▲
DSMR.8.160.050.20	16	0,5	32	16	89	8	▲
DSMR.8.160.050.30	16	0,5	48	16	100	8	▲
DSMR.8.160.050.40	16	0,5	64	16	120	8	▲
DSMR.8.160.100.20	16	1,0	32	16	89	8	▲
DSMR.8.160.100.30	16	1,0	48	16	100	8	▲
DSMR.8.160.100.40	16	1,0	64	16	120	8	▲
DSMR.8.200.020.20	20	0,2	40	20	102	8	▲
DSMR.8.200.020.30	20	0,2	60	20	125	8	▲
DSMR.8.200.020.40	20	0,2	80	20	150	8	▲
DSMR.8.200.050.20	20	0,5	40	20	102	8	▲
DSMR.8.200.050.30	20	0,5	60	20	125	8	▲
DSMR.8.200.050.40	20	0,5	80	20	150	8	▲
DSMR.8.200.100.20	20	1,0	40	20	102	8	▲
DSMR.8.200.100.30	20	1,0	60	20	125	8	▲
DSMR.8.200.100.40	20	1,0	80	20	150	8	▲

▲ ab Lager / on stock Δ 4 Wochen / 4 weeks x auf Anfrage / upon request

● empfohlen / recommended

o bedingt einsetzbar / alternative recommendation

- nicht geeignet / not suitable

■ unbeschichtete HM-Sorten / uncoated grades

■ beschichtete HM-Sorten / coated grades

■ bestückt/Cermet / brazed/Cermet

Abmessungen in mm

Dimensions in mm

P	●
M	○
K	○
N	-
S	○
H	○

HM-Sorten  
Carbide grades



# Schnittdaten DSMR Ø 16 - 20 mm

## Cutting Data DSMR Ø 16 - 20 mm

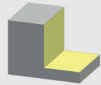
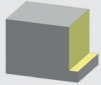

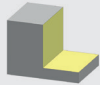
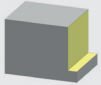
	 vc = m/min	 vc = m/min
P1.1	140	170
P1.2	140	170
P1.3	130	160
P2.1	120	140
P2.2	120	140
P2.3	120	140
P3.1	100	120
P3.2	90	110
M1.1	80	100
M2.1	60	70
M3.1	45	50

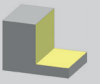
	 vc = m/min	 vc = m/min
K1.1	120	140
K1.2	100	120
K2.1	100	120
K2.2	80	100
K3.1	70	80
K3.2	60	70
S1	55	70
S2	40	50
S3	35	40
-	-	-
-	-	-

d <sub>1</sub>	 α						
		f <sub>z</sub>	a <sub>e</sub>	a <sub>p</sub>	f <sub>z</sub>	a <sub>e</sub>	a <sub>p</sub>
16	3°	0,047	1,60	32,00	0,085	0,48	32,00
16	3°	0,047	1,60	48,00	0,085	0,48	48,00
16	3°	0,047	1,60	64,00	0,085	0,48	64,00
16	3°	0,047	1,60	32,00	0,085	0,48	32,00
16	3°	0,047	1,60	48,00	0,085	0,48	48,00
16	3°	0,047	1,60	64,00	0,085	0,48	64,00
16	3°	0,047	1,60	32,00	0,085	0,48	32,00
16	3°	0,047	1,60	48,00	0,085	0,48	48,00
16	3°	0,047	1,60	64,00	0,085	0,48	64,00
20	3°	0,062	2,00	40,00	0,110	0,60	40,00
20	3°	0,062	2,00	60,00	0,110	0,60	60,00
20	3°	0,062	2,00	80,00	0,110	0,60	80,00
20	3°	0,062	2,00	40,00	0,110	0,60	40,00
20	3°	0,062	2,00	60,00	0,110	0,60	60,00
20	3°	0,062	2,00	80,00	0,110	0,60	80,00
20	3°	0,062	2,00	40,00	0,110	0,60	40,00
20	3°	0,062	2,00	60,00	0,110	0,60	60,00
20	3°	0,062	2,00	80,00	0,110	0,60	80,00

Abmessungen in mm  
Dimensions in mm

B

# Schruppfräser, Eckradius

## Roughing End Mil, corner radius



### DSR

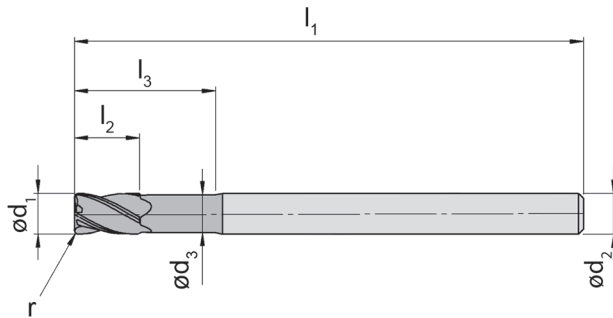
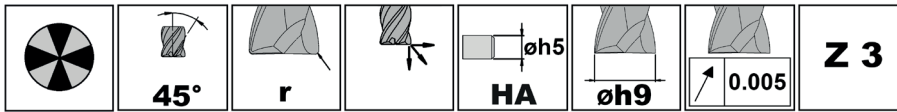

Bis Ø 3 mm vormontiert lieferbar für Toodle Schnelllaufspindel (siehe Seite D2)  
Pre-assembled available up to Ø 3 mm for Toodle high-speed spindle (see page D2)

Bestellnummer Part number	d <sub>1</sub>	r	l <sub>2</sub>	l <sub>3</sub>	d <sub>3</sub>	d <sub>2</sub>	l <sub>1</sub>	Z	TS3K
DSR.3.020.38.03	2	0,2	3	10,5	1,9	3	38	3	▲
DSR.3.030.38.03	3	0,2	4	10,5	2,9	3	38	3	▲
DSR.3.040.50.06	4	0,2	5	12,5	3,8	6	50	3	▲
DSR.3.040.63.06	4	0,2	5	12,5	3,8	6	63	3	▲
DSR.3.050.50.06	5	0,2	6	14,5	4,7	6	50	3	▲
DSR.3.050.63.06	5	0,2	6	14,5	4,7	6	63	3	▲
DSR.3.060.63.06	6	0,3	7	16,5	5,6	6	63	3	▲
DSR.3.080.63.08	8	0,5	9	20,5	7,4	8	63	3	▲
DSR.3.100.69.10	10	0,5	12	25,5	9,4	10	69	3	▲
DSR.3.120.77.12	12	0,5	15	30,5	11,4	12	77	3	▲

▲ ab Lager / on stock Δ 4 Wochen / 4 weeks x auf Anfrage / upon request

● empfohlen / recommended

o bedingt einsetzbar / alternative recommendation

- nicht geeignet / not suitable

□ unbeschichtete HM-Sorten / uncoated grades

■ beschichtete HM-Sorten / coated grades

■ bestückt/Cermet / brazed/Cermet

Abmessungen in mm

Dimensions in mm

P	●
M	○
K	○
N	-
S	○
H	○



HM-Sorten  
Carbide grades

# Schnittdaten DSR Ø 2 - 12 mm

Cutting Data DSR Ø 2 - 12 mm

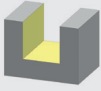
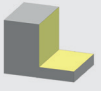

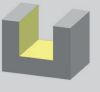
	 vc = m/min	 vc = m/min
P1.1	160	190
P1.2	160	190
P1.3	150	180
P2.1	140	170
P2.2	140	170
P2.3	140	170
P3.1	120	140
P3.2	110	130

d <sub>1</sub>							
		f <sub>z</sub>	a <sub>e</sub>	a <sub>p</sub>	f <sub>z</sub>	a <sub>e</sub>	a <sub>p</sub>
2	5°	0,007	2	2	0,014	0,50	2,00
3	5°	0,011	3	3	0,022	0,75	3,00
4	5°	0,015	4	4	0,030	1,00	4,00
4	5°	0,015	4	4	0,030	1,00	4,00
5	5°	0,019	5	5	0,038	1,25	5,00
5	5°	0,019	5	5	0,038	1,25	5,00
6	5°	0,023	6	6	0,046	1,50	6,00
8	5°	0,031	8	8	0,062	2,00	8,00
10	5°	0,039	10	10	0,078	2,50	10,00
12	5°	0,047	12	12	0,094	3,00	12,00

Abmessungen in mm

Dimensions in mm



# Schruppfräser, Eckfase

## Roughing End Mil, corner chamfer



### DSF

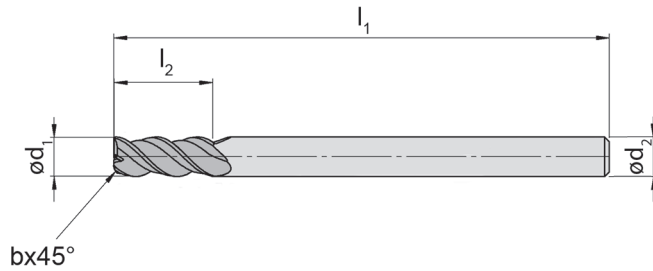
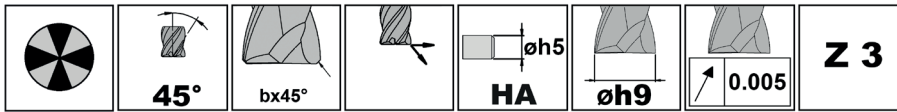

Bis Ø 3 mm vormontiert lieferbar für Toodle Schnelllaufspindel (siehe Seite D2)  
Pre-assembled available up to Ø 3 mm for Toodle high-speed spindle (see page D2)

Bestellnummer Part number	d <sub>1</sub>	b	l <sub>2</sub>	d <sub>2</sub>	l <sub>1</sub>	Z	TS3K
<b>DSF.3.020.38.03</b>	2	0,10	8	3	38	3	▲
<b>DSF.3.030.38.03</b>	3	0,10	10	3	38	3	▲
<b>DSF.3.040.50.04</b>	4	0,10	12	4	50	3	▲
<b>DSF.3.050.50.05</b>	5	0,15	14	5	50	3	▲
<b>DSF.3.060.63.06</b>	6	0,15	16	6	63	3	▲
<b>DSF.3.080.63.08</b>	8	0,20	20	8	63	3	▲
<b>DSF.3.100.69.10</b>	10	0,20	22	10	69	3	▲
<b>DSF.3.120.77.12</b>	12	0,25	25	12	77	3	▲
<b>DSF.3.160.88.16</b>	16	-	35	16	88	3	▲

▲ ab Lager / on stock Δ 4 Wochen / 4 weeks x auf Anfrage / upon request

● empfohlen / recommended

o bedingt einsetzbar / alternative recommendation

- nicht geeignet / not suitable

■ unbeschichtete HM-Sorten / uncoated grades

■ beschichtete HM-Sorten / coated grades

■ bestückt/Cermet / brazed/Cermet

Abmessungen in mm

Dimensions in mm

P	●
M	○
K	○
N	-
S	○
H	○



HM-Sorten  
Carbide grades

# Schnittdaten DSF Ø 2 - 16 mm

Cutting Data DSF Ø 2 - 16 mm

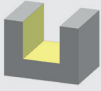
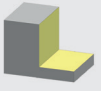

	 vc = m/min	 vc = m/min
P1.1	160	190
P1.2	160	190
P1.3	150	180
P2.1	140	170
P2.2	140	170
P2.3	140	170
P3.1	120	140
P3.2	110	130

d <sub>1</sub>							
		f <sub>z</sub>	a <sub>e</sub>	a <sub>p</sub>	f <sub>z</sub>	a <sub>e</sub>	a <sub>p</sub>
2	5°	0,008	2	2	0,016	0,50	4,00
3	5°	0,012	3	3	0,024	0,75	6,00
4	5°	0,016	4	4	0,032	1,00	8,00
5	5°	0,020	5	5	0,040	1,25	10,00
6	5°	0,024	6	6	0,048	1,50	12,00
8	5°	0,032	8	8	0,064	2,00	16,00
10	5°	0,040	10	10	0,080	2,50	20,00
12	5°	0,048	12	12	0,096	3,00	24,00
16	5°	0,064	16	16	0,128	4,00	32,00

Abmessungen in mm  
Dimensions in mm





# Schruppfräser, Eckfase

## Roughing End Mil, corner chamfer



### DSF

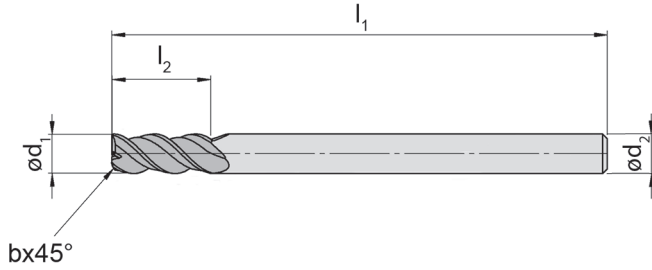
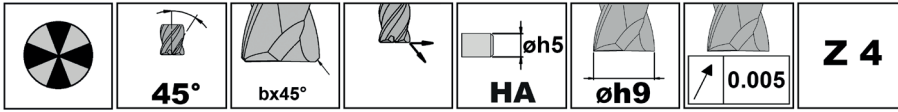

B

Bestellnummer Part number	d <sub>1</sub>	b	l <sub>2</sub>	d <sub>2</sub>	l <sub>1</sub>	Z	TS3K
<b>DSF.4.040.50.04</b>	4	0,10	12	4	50	4	▲
<b>DSF.4.060.63.06</b>	6	0,15	16	6	63	4	▲
<b>DSF.4.080.63.08</b>	8	0,20	20	8	63	4	▲
<b>DSF.4.100.69.10</b>	10	0,20	22	10	69	4	▲
<b>DSF.4.120.77.12</b>	12	0,25	25	12	77	4	▲
<b>DSF.4.160.88.16</b>	16	-	35	16	88	4	▲

- ▲ ab Lager / on stock Δ 4 Wochen / 4 weeks x auf Anfrage / upon request
- empfohlen / recommended
- bedingt einsetzbar / alternative recommendation
- nicht geeignet / not suitable
- unbeschichtete HM-Sorten / uncoated grades
- beschichtete HM-Sorten / coated grades
- bestückt/Cermet / brazed/Cermet

P	●
M	○
K	○
N	-
S	○
H	○



Abmessungen in mm  
Dimensions in mm



HM-Sorten  
Carbide grades

# Schnittdaten DSF Ø 4 - 16 mm

## Cutting Data DSF Ø 4 - 16 mm



	 vc = m/min	 vc = m/min
P1.1	160	190
P1.2	160	190
P1.3	150	180
P2.1	140	170
P2.2	140	170
P2.3	140	170
P3.1	120	140
P3.2	110	130

d <sub>1</sub>							
		f <sub>z</sub>	a <sub>e</sub>	a <sub>p</sub>	f <sub>z</sub>	a <sub>e</sub>	a <sub>p</sub>
4	4°	0,012	4	4	0,025	1,00	8,00
6	4°	0,020	6	6	0,041	1,50	12,00
8	4°	0,028	8	8	0,057	2,00	16,00
10	4°	0,036	10	10	0,073	2,50	20,00
12	4°	0,044	12	12	0,089	3,00	24,00
16	4°	0,060	16	16	0,121	4,00	32,00

Abmessungen in mm  
Dimensions in mm



# Schaftfräser Trochoidalfräsen

## End Mill Trochoidal Milling



### DSFT

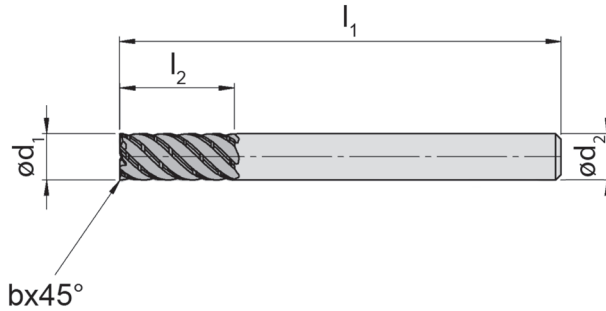
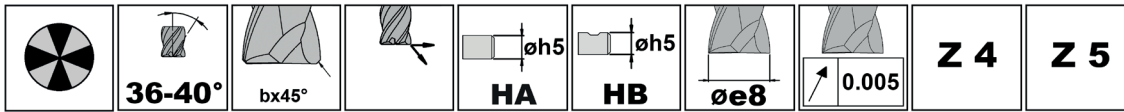

Bis Ø 3 mm vormontiert lieferbar für Toodle Schnelllaufspindel (siehe Seite D2)  
Pre-assembled available up to Ø 3 mm for Toodle high-speed spindle (see page D2)

Bestellnummer Part number	d <sub>1</sub>	b	l <sub>2</sub>	d <sub>2</sub>	l <sub>1</sub>	Z	γ	Ausführung Type	TS3K
DSFT.4.020.010.20	2	0,10	5	6	50	4	40°	HA	▲
DSFT.4.020.010.30	2	0,10	7	6	50	4	40°	HA	▲
DSFT.4.020.010.40	2	0,10	9	6	54	4	40°	HA	▲
DSFT.4.030.010.20	3	0,10	7	6	50	4	40°	HA	▲
DSFT.4.030.010.30	3	0,10	10	6	54	4	40°	HA	▲
DSFT.4.030.010.40	3	0,10	13	6	57	4	40°	HA	▲
DSFT.4.040.010.20	4	0,10	9	6	50	4	40°	HA	▲
DSFT.4.040.010.30	4	0,10	13	6	57	4	40°	HA	▲
DSFT.4.040.010.40	4	0,10	17	6	60	4	40°	HA	▲
DSFT.4.050.010.20	5	0,10	11	6	50	4	40°	HA	▲
DSFT.4.050.010.30	5	0,10	16	6	57	4	40°	HA	▲
DSFT.4.050.010.40	5	0,10	21	6	64	4	40°	HA	▲
DSFT.5.060.010.20	6	0,10	13	6	57	5	-	HA	▲
DSFT.5.060.010.30	6	0,10	19	6	64	5	-	HA	▲
DSFT.5.060.010.40	6	0,10	25	6	64	5	-	HA	▲
DSFT.5.080.015.20	8	0,15	17	8	57	5	-	HA	▲
DSFT.5.080.015.30	8	0,15	25	8	64	5	-	HA	▲
DSFT.5.080.015.40	8	0,15	33	8	72	5	-	HA	▲
DSFT.5.100.020.20	10	0,20	21	10	64	5	-	HA	▲
DSFT.5.100.020.20B	10	0,20	21	10	64	5	-	HB	▲
DSFT.5.100.020.30	10	0,20	31	10	78	5	-	HA	▲
DSFT.5.100.020.30B	10	0,20	31	10	78	5	-	HB	▲
DSFT.5.100.020.40	10	0,20	41	10	89	5	-	HA	▲
DSFT.5.100.020.40B	10	0,20	41	10	89	5	-	HB	▲

▲ ab Lager / on stock Δ 4 Wochen / 4 weeks x auf Anfrage / upon request

● empfohlen / recommended

o bedingt einsetzbar / alternative recommendation

- nicht geeignet / not suitable

■ unbeschichtete HM-Sorten / uncoated grades

■ beschichtete HM-Sorten / coated grades

■ bestückt/Cermet / brazed/Cermet

Abmessungen in mm

Dimensions in mm

P	•
M	◦
K	◦
N	-
S	◦
H	◦



HM-Sorten  
Carbide grades

# Schnittdaten DSFT Ø 2 - 10 mm

## Cutting Data DSF Ø 2 - 10 mm

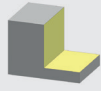
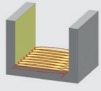

	 vc = m/min	 vc = m/min
P1.1	170	200
P1.2	170	200
P1.3	160	190
P2.1	160	190
P2.2	150	180
P2.3	150	180
P3.1	140	170
P3.2	140	170

d <sub>1</sub>							
		f <sub>z</sub>	a <sub>e</sub>	a <sub>p</sub>	f <sub>z</sub>	a <sub>e</sub>	a <sub>p</sub>
2	3°	0,017	0,40	4,0	0,030	0,20	4,0
2	3°	0,016	0,36	6,0	0,029	0,18	6,0
2	3°	0,015	0,32	8,0	0,027	0,16	8,0
3	3°	0,029	0,60	6,0	0,048	0,30	6,0
3	3°	0,028	0,54	9,0	0,045	0,27	9,0
3	3°	0,026	0,48	12,0	0,043	0,24	12,0
4	3°	0,042	0,80	8,0	0,065	0,40	8,0
4	3°	0,040	0,72	12,0	0,062	0,36	12,0
4	3°	0,037	0,64	16,0	0,059	0,32	16,0
5	3°	0,054	1,00	10,0	0,083	0,50	10,0
5	3°	0,051	0,90	15,0	0,079	0,45	15,0
5	3°	0,048	0,80	20,0	0,074	0,40	20,0
6	3°	0,062	1,20	12,0	0,094	0,60	12,0
6	3°	0,059	1,08	18,0	0,089	0,54	18,0
6	3°	0,055	0,96	24,0	0,084	0,48	24,0
8	3°	0,087	1,60	16,0	0,129	0,80	16,0
8	3°	0,082	1,44	24,0	0,122	0,72	24,0
8	3°	0,078	1,28	32,0	0,115	0,64	32,0
10	3°	0,112	2,00	20,0	0,164	1,00	20,0
10	3°	0,106	1,80	30,0	0,156	0,90	30,0
10	3°	0,100	1,60	40,0	0,147	0,80	40,0
10	3°	0,112	2,00	20,0	0,164	1,00	20,0
10	3°	0,106	1,80	30,0	0,156	0,90	30,0
10	3°	0,100	1,60	40,0	0,147	0,80	40,0

Abmessungen in mm  
Dimensions in mm

B

# Schaftfräser Trochoidalfräsen

## End Mill Trochoidal Milling



### DSFT

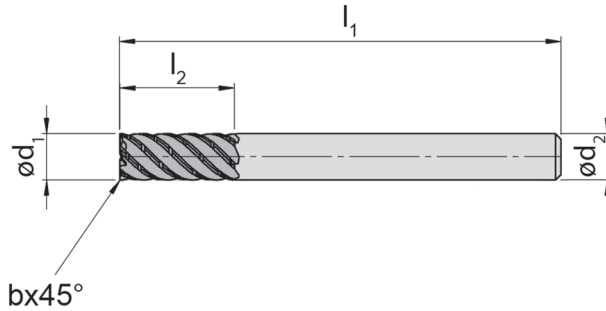
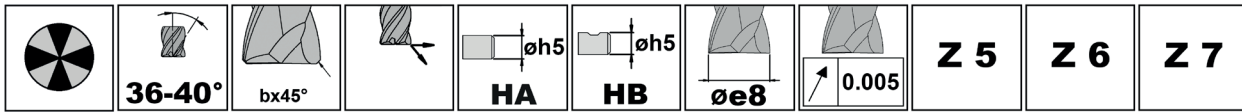

Bestellnummer Part number	d <sub>1</sub>	b	l <sub>2</sub>	d <sub>2</sub>	l <sub>1</sub>	Z	Ausführung Type	TS3K
DSFT.6.120.020.20	12	0,2	26	12	78	6	HA	▲
DSFT.6.120.020.20B	12	0,2	26	12	78	6	HB	▲
DSFT.6.120.020.30	12	0,2	38	12	100	6	HA	▲
DSFT.6.120.020.30B	12	0,2	38	12	100	6	HB	▲
DSFT.5.120.020.40	12	0,2	50	12	110	5	HA	▲
DSFT.5.120.020.40B	12	0,2	50	12	110	5	HB	▲
DSFT.6.160.030.20	16	0,3	34	16	100	6	HA	▲
DSFT.6.160.030.20B	16	0,3	34	16	100	6	HB	▲
DSFT.6.160.030.30	16	0,3	50	16	120	6	HA	▲
DSFT.6.160.030.30B	16	0,3	50	16	120	6	HB	▲
DSFT.5.160.030.40	16	0,3	66	16	130	5	HA	▲
DSFT.5.160.030.40B	16	0,3	66	16	130	5	HB	▲
DSFT.7.200.040.20	20	0,4	42	20	100	7	HA	▲
DSFT.7.200.040.20B	20	0,4	42	20	100	7	HB	▲
DSFT.7.200.040.30	20	0,4	62	20	120	7	HA	▲
DSFT.7.200.040.30B	20	0,4	62	20	120	7	HB	▲
DSFT.5.200.040.40	20	0,4	82	20	140	5	HA	▲
DSFT.5.200.040.40B	20	0,4	82	20	140	5	HB	▲

▲ ab Lager / on stock Δ 4 Wochen / 4 weeks x auf Anfrage / upon request

● empfohlen / recommended

o bedingt einsetzbar / alternative recommendation

- nicht geeignet / not suitable

■ unbeschichtete HM-Sorten / uncoated grades

■ beschichtete HM-Sorten / coated grades

■ bestückt/Cermet / brazed/Cermet

Abmessungen in mm

Dimensions in mm

HM-Sorten Carbide grades	TS3K
P	●
M	○
K	○
N	-
S	○
H	○

HM-Sorten  
Carbide grades

# Schnittdaten DSFT Ø 12 - 20 mm

## Cutting Data DSF Ø 12 - 20 mm

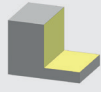
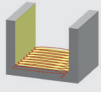

	 vc = m/min	 vc = m/min
P1.1	170	200
P1.2	170	200
P1.3	160	190
P2.1	160	190
P2.2	150	180
P2.3	150	180
P3.1	140	170
P3.2	140	170

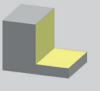
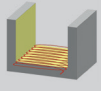
d <sub>1</sub>							
		f <sub>z</sub>	a <sub>e</sub>	a <sub>p</sub>	f <sub>z</sub>	a <sub>e</sub>	a <sub>p</sub>
12	3°	0,133	2,40	24,0	0,195	1,20	24,0
12	3°	0,127	2,16	36,0	0,185	1,08	36,0
12	3°	0,119	1,92	48,0	0,174	0,96	48,0
12	3°	0,133	2,40	24,0	0,195	1,20	24,0
12	3°	0,127	2,16	36,0	0,185	1,08	36,0
12	3°	0,119	1,92	48,0	0,174	0,96	48,0
16	3°	0,183	3,20	32,0	0,265	1,60	32,0
16	3°	0,174	2,88	48,0	0,252	1,44	48,0
16	3°	0,164	2,56	64,0	0,237	1,28	64,0
16	3°	0,183	3,20	32,0	0,265	1,60	32,0
16	3°	0,174	2,88	48,0	0,252	1,44	48,0
16	3°	0,164	2,56	64,0	0,237	1,28	64,0
20	3°	0,231	4,00	40,0	0,332	2,00	40,0
20	3°	0,219	3,60	60,0	0,315	1,80	60,0
20	3°	0,206	3,20	80,0	0,297	1,60	80,0
20	3°	0,231	4,00	40,0	0,332	2,00	40,0
20	3°	0,219	3,60	60,0	0,315	1,80	60,0
20	3°	0,206	3,20	80,0	0,297	1,60	80,0

Abmessungen in mm  
Dimensions in mm

B

### DSH

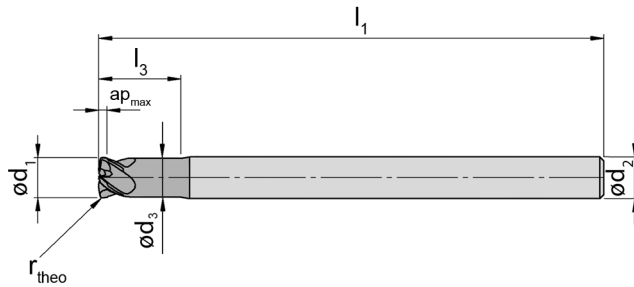
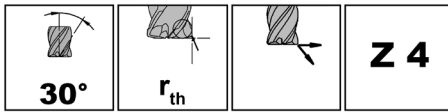

Bis Ø 3 mm vormontiert lieferbar für Toodle Schnelllaufspindel (siehe Seite D2)  
 Pre-assembled available up to Ø 3 mm for Toodle high-speed spindle (see page D2)

Bestellnummer Part number	d <sub>1</sub>	r <sub>theo</sub>	l <sub>3</sub>	d <sub>3</sub>	d <sub>2</sub>	l <sub>1</sub>	Z	Ausführung Type	a <sub>p</sub>	TS3K
DSH.4.020.035.020	2	0,35	4	1,8	6	50	4	HA	0,20	▲
DSH.4.020.035.030	2	0,35	6	1,8	6	50	4	HA	0,20	▲
DSH.4.030.050.020	3	0,50	6	2,7	6	50	4	HA	0,30	▲
DSH.4.030.050.030	3	0,50	9	2,7	6	50	4	HA	0,30	▲
DSH.4.040.070.020	4	0,70	8	3,6	6	50	4	HA	0,35	▲
DSH.4.040.070.030	4	0,70	12	3,6	6	57	4	HA	0,35	▲
DSH.4.050.080.020	5	0,80	10	4,5	6	50	4	HA	0,38	▲
DSH.4.050.080.030	5	0,80	15	4,5	6	57	4	HA	0,38	▲
DSH.4.060.080.020	6	0,80	12	5,4	6	50	4	HA	0,40	▲
DSH.4.060.080.030	6	0,80	18	5,4	6	64	4	HA	0,40	▲
DSH.4.080.140.020	8	1,40	16	7,2	8	60	4	HA	0,50	▲
DSH.4.080.140.030	8	1,40	24	7,2	8	63	4	HA	0,50	▲
DSH.4.100.200.020	10	2,00	20	9,0	10	70	4	HA	0,70	▲
DSH.4.100.200.030	10	2,00	30	9,0	10	78	4	HA	0,70	▲
DSH.4.120.210.020	12	2,10	24	10,8	12	78	4	HA	0,80	▲
DSH.4.120.210.030	12	2,10	36	10,8	12	89	4	HA	0,80	▲
DSH.4.160.280.020	16	2,80	32	-	16	89	4	HA	1,00	▲
DSH.4.160.280.030	16	2,80	48	-	16	100	4	HA	1,00	▲

▲ ab Lager / on stock Δ 4 Wochen / 4 weeks x auf Anfrage / upon request

● empfohlen / recommended

o bedingt einsetzbar / alternative recommendation

- nicht geeignet / not suitable

■ unbeschichtete HM-Sorten / uncoated grades

■ beschichtete HM-Sorten / coated grades

■ bestückt/Cermet / brazed/Cermet

Abmessungen in mm

Dimensions in mm



P	●
M	○
K	○
N	-
S	○
H	○



HM-Sorten  
Carbide grades

# Schnittdaten DSH Ø 2 - 16 mm

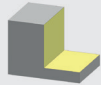

Cutting Data DSH Ø 2 - 16 mm

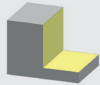

	 $vc = m/min$	 $vc = m/min$
P1.1	170	200
P1.2	170	200
P1.3	160	190
P2.1	160	190
P2.2	150	180
P2.3	150	180
P3.1	140	170
P3.2	140	170
M1.1	120	140
M2.1	110	130
M3.1	100	120

	 $vc = m/min$	 $vc = m/min$
K1.1	140	170
K1.2	140	170
K2.1	130	160
K2.2	130	160
K3.1	120	140
K3.2	120	140
S1	100	120
S2	80	100
S3	70	80
-	-	-
-	-	-

**B**

$d_1$							
		$f_z$	$a_e$	$a_p$	$f_z$	$a_e$	$a_p$
2	3°	0,070	2	0,15	0,081	1,50	0,17
2	3°	0,070	2	0,14	0,081	1,50	0,15
3	3°	0,110	3	0,20	0,128	2,25	0,23
3	3°	0,110	3	0,20	0,128	2,25	0,23
4	3°	0,150	4	0,24	0,174	3,00	0,27
4	3°	0,150	4	0,24	0,174	3,00	0,27
5	3°	0,190	5	0,26	0,220	3,75	0,29
5	3°	0,190	5	0,26	0,220	3,75	0,29
6	3°	0,230	6	0,27	0,266	4,50	0,31
6	3°	0,230	6	0,27	0,266	4,50	0,31
8	3°	0,310	8	0,34	0,359	6,00	0,38
8	3°	0,310	8	0,34	0,359	6,00	0,38
10	3°	0,390	10	0,47	0,451	7,50	0,54
10	3°	0,390	10	0,47	0,451	7,50	0,54
12	3°	0,470	12	0,54	0,543	9,00	0,61
12	3°	0,470	12	0,54	0,543	9,00	0,61
16	3°	0,630	16	0,68	0,728	12,00	0,77
16	3°	0,630	16	0,68	0,728	12,00	0,77

Abmessungen in mm  
Dimensions in mm



# Fasfräser

## Chamfer Milling Cutter



# DSFF

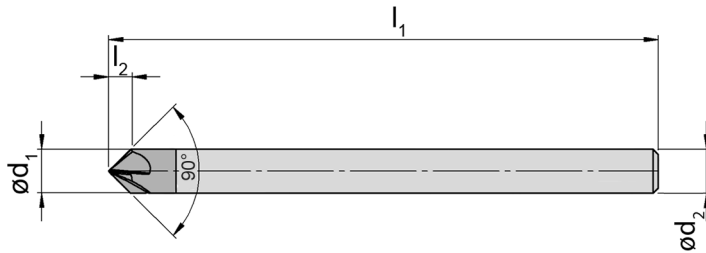
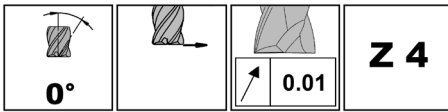

Bestellnummer Part number	d <sub>1</sub>	l <sub>2</sub>	d <sub>2</sub>	l <sub>1</sub>	Z	TS3K
<b>DSFF.4.04.50.04.45</b>	4	2	4	50	4	▲
<b>DSFF.4.06.63.06.45</b>	6	3	6	63	4	▲
<b>DSFF.4.08.63.08.45</b>	8	4	8	63	4	▲
<b>DSFF.4.10.69.10.45</b>	10	5	10	69	4	▲
<b>DSFF.4.12.77.12.45</b>	12	6	12	77	4	▲

▲ ab Lager / on stock Δ 4 Wochen / 4 weeks x auf Anfrage / upon request

● empfohlen / recommended

○ bedingt einsetzbar / alternative recommendation

- nicht geeignet / not suitable

□ unbeschichtete HM-Sorten / uncoated grades

■ beschichtete HM-Sorten / coated grades

■ bestückt/Cermet / brazed/Cermet

Abmessungen in mm

Dimensions in mm

P	●
M	○
K	○
N	-
S	○
H	○

HM-Sorten  
Carbide grades

B



# Schnittdaten DSFF Ø 4 - 12 mm

## Cutting Data DSFF Ø 4 - 14 mm

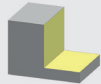
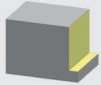

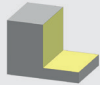
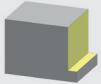
	 vc = m/min	 vc = m/min
P1.1	140	170
P1.2	140	170
P1.3	130	160
P2.1	120	140
P2.2	120	140
P2.3	120	140
P3.1	100	120
P3.2	90	110
M1.1	80	100
M2.1	60	70
M3.1	45	50

	 vc = m/min	 vc = m/min
K1.1	120	140
K1.2	100	120
K2.1	100	120
K2.2	80	100
K3.1	70	80
K3.2	60	70
S1	55	70
S2	40	50
S3	35	40
-	-	-
-	-	-

d <sub>1</sub>						
	f <sub>z</sub>	a <sub>e</sub>	a <sub>p</sub>	f <sub>z</sub>	a <sub>e</sub>	a <sub>p</sub>
4	0,030	0,60	0,60	0,050	0,10	0,10
6	0,040	0,75	0,75	0,060	0,15	0,15
8	0,450	1,00	1,00	0,070	0,20	0,20
10	0,050	1,25	1,25	0,080	0,25	0,25
12	0,060	1,50	1,50	0,080	0,30	0,30

Abmessungen in mm  
Dimensions in mm









B

# Vollhartmetall-Schaftfräser

Solid Carbide End Mills

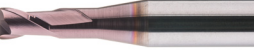

B

	DSKMH	Schaftfräser Vollradius Mikro Ball Nose End Mill Micro	Ø 0,2 – Ø 3	Z 2	B74 – B77
	DSK.2	Schaftfräser Vollradius Ball nose End Mill	Ø 4 – Ø 16	Z 2	B78 – B79
	DSK.4	Schaftfräser Vollradius Ball nose End Mill	Ø 4 – Ø 12	Z 4	B80 – B81
	DSTMH	Torusfräser Mikro Torus End Mill Micro	Ø 0,1 – Ø 3	Z 2	B82 – B89
	DSTH.2	Torusfräser Torus End Mill	Ø 4 – Ø 12	Z 2	B90 – B101
	DSTH.4	Torusfräser Torus End Mill	Ø 4 – Ø 12	Z 4	B102 – B111
	DSMH	Schaftfräser Mehrschneider End Mill multiple fluted	Ø 3 – Ø 12	Z 6	B112 – B113
	DSMRH	Schaftfräser Mehrschneider, Eckenradius End Mill multiple fluted, corner radius	Ø 3 – Ø 12	Z 6	B114–115

**DS**

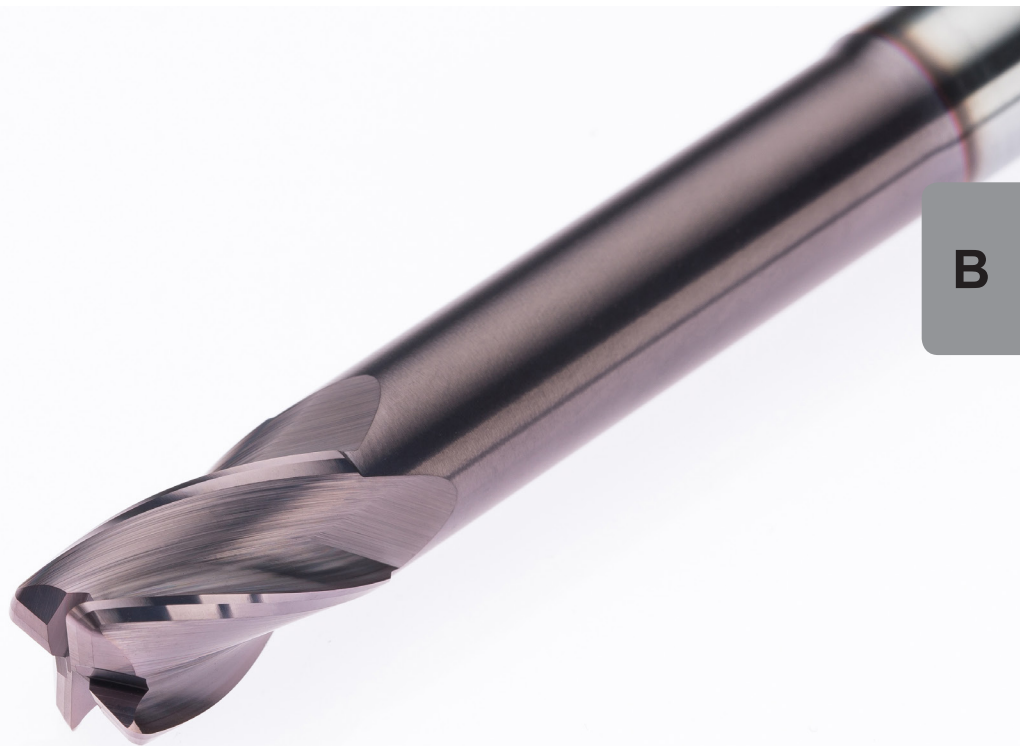

**abgestimmt für:**

**- gehärtete Stähle**

**designed for:**

**- hardened Steels**

# Schaftfräser Vollradius Mikro

Ball Nose End Mill Micro



## DSKMH

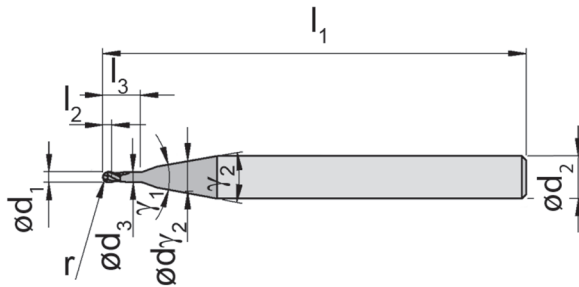
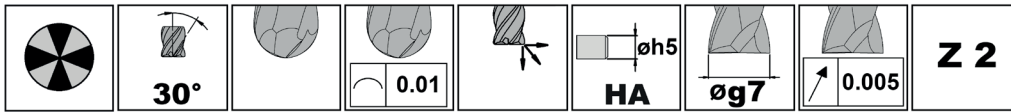

Bis Ø 3 mm vormontiert lieferbar für Toodle Schnelllaufspindel (siehe Seite D2)  
Pre-assembled available up to Ø 3 mm for Toodle high-speed spindle (see page D2)

Bestellnummer Part number	d <sub>1</sub>	r	l <sub>2</sub>	l <sub>3</sub>	d <sub>3</sub>	d <sub>2</sub>	l <sub>1</sub>	Z	γ <sub>1</sub>	γ <sub>2</sub>	d <sub>v2</sub>	TS3E
DSKMH.020.015	0,2	0,10	0,30	-	-	4	50	2	20°	-°	-	▲
DSKMH.020.030	0,2	0,10	0,30	0,6	0,18	4	50	2	40°	20°	1,5	▲
DSKMH.020.050	0,2	0,10	0,30	1,0	0,18	4	50	2	40°	20°	1,5	▲
DSKMH.030.015	0,3	0,15	0,45	-	-	4	50	2	20°	-°	-	▲
DSKMH.030.030	0,3	0,15	0,45	0,9	0,28	4	50	2	40°	20°	1,5	▲
DSKMH.030.050	0,3	0,15	0,45	1,5	0,28	4	50	2	40°	20°	1,5	▲
DSKMH.040.015	0,4	0,20	0,60	-	-	4	50	2	20°	-°	-	▲
DSKMH.040.030	0,4	0,20	0,60	1,2	0,38	4	50	2	40°	20°	1,5	▲
DSKMH.040.050	0,4	0,20	0,60	2,0	0,38	4	50	2	40°	20°	1,5	▲
DSKMH.050.015	0,5	0,25	0,75	-	-	4	50	2	20°	-°	-	▲
DSKMH.050.030	0,5	0,25	0,75	1,5	0,47	4	50	2	40°	20°	1,5	▲
DSKMH.050.050	0,5	0,25	0,75	2,5	0,47	4	50	2	40°	20°	1,5	▲
DSKMH.050.070	0,5	0,25	0,75	3,5	0,47	4	50	2	40°	20°	1,5	▲
DSKMH.060.015	0,6	0,30	0,90	-	-	4	50	2	20°	-°	-	▲
DSKMH.060.030	0,6	0,30	0,90	1,8	0,56	4	50	2	40°	20°	1,5	▲
DSKMH.060.050	0,6	0,30	0,90	3,0	0,56	4	50	2	40°	20°	1,5	▲
DSKMH.060.070	0,6	0,30	0,90	4,2	0,56	4	50	2	40°	20°	1,5	▲
DSKMH.080.015	0,8	0,40	-	1,2	-	4	50	2	20°	-°	-	▲
DSKMH.080.030	0,8	0,40	1,20	2,4	0,75	4	50	2	40°	20°	1,5	▲
DSKMH.080.050	0,8	0,40	1,20	4,0	0,75	4	50	2	40°	20°	1,5	▲
DSKMH.080.070	0,8	0,40	1,20	5,6	0,75	4	50	2	40°	20°	1,5	▲

▲ ab Lager / on stock Δ 4 Wochen / 4 weeks x auf Anfrage / upon request

● empfohlen / recommended

o bedingt einsetzbar / alternative recommendation

- nicht geeignet / not suitable

■ unbeschichtete HM-Sorten / uncoated grades

■ beschichtete HM-Sorten / coated grades

■ bestückt/Cermet / brazed/Cermet

Abmessungen in mm

Dimensions in mm

P	-
M	-
K	-
N	-
S	-
H	●



HM-Sorten  
Carbide grades

# Schnittdaten DSKMH Ø 0,2 - 0,8 mm



## Cutting Data DSKMH Ø 0,2 - 0,8 mm

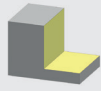

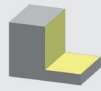

### Konventionelles Fräsen / Conventional milling

		
	vc = m/min	vc = m/min
H1.1	120	150
H1.2	100	130
H1.3	80	100
H1.4	70	90

### HSC Fräsen / HSC milling

		
	vc = m/min	vc = m/min
H1.1	180	220
H1.2	160	190
H1.3	140	170
H1.4	120	140

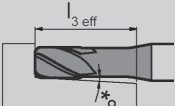

d <sub>1</sub>												
		0°	0,5°	1°	2°	3°	f <sub>z</sub>	a <sub>e</sub>	a <sub>p</sub>	f <sub>z</sub>	a <sub>e</sub>	a <sub>p</sub>
0,2	5°	0,30	0,50	0,50	0,60	0,60	0,004	0,04	0,03	0,008	0,01	0,02
0,2	4°	0,60	0,70	0,70	0,80	0,90	0,004	0,04	0,03	0,008	0,01	0,02
0,2	3°	1,00	0,90	0,90	1,00	1,20	0,004	0,04	0,02	0,007	0,01	0,02
0,3	5°	0,45	1,10	1,10	1,20	1,50	0,005	0,06	0,05	0,010	0,02	0,03
0,3	4°	0,90	1,30	1,30	1,40	1,80	0,005	0,06	0,04	0,010	0,02	0,03
0,3	3°	1,50	1,50	1,50	1,60	2,10	0,005	0,06	0,03	0,009	0,02	0,02
0,4	5°	0,60	1,70	1,70	1,80	2,40	0,007	0,08	0,06	0,012	0,02	0,04
0,4	4°	1,20	1,90	1,90	2,00	2,70	0,007	0,08	0,05	0,012	0,02	0,04
0,4	3°	2,00	2,10	2,10	2,20	3,00	0,006	0,08	0,04	0,011	0,02	0,03
0,5	5°	0,75	2,30	2,30	2,40	3,30	0,008	0,10	0,08	0,014	0,03	0,05
0,5	4°	1,50	2,50	2,50	2,60	3,60	0,008	0,10	0,07	0,014	0,03	0,05
0,5	3°	2,50	2,70	2,70	2,80	3,90	0,007	0,10	0,06	0,013	0,03	0,04
0,5	2°	3,50	2,90	2,90	3,00	4,20	0,006	0,10	0,05	0,011	0,03	0,03
0,6	5°	0,90	3,10	3,10	3,20	4,50	0,009	0,12	0,09	0,016	0,03	0,06
0,6	4°	1,80	3,30	3,30	3,40	4,80	0,009	0,12	0,08	0,016	0,03	0,06
0,6	3°	3,00	3,50	3,50	3,60	5,10	0,008	0,12	0,07	0,014	0,03	0,05
0,6	2°	4,20	3,70	3,70	3,80	5,40	0,007	0,12	0,05	0,013	0,03	0,04
0,8	5°	1,20	3,90	3,90	4,00	5,70	0,011	0,16	0,12	0,020	0,04	0,08
0,8	4°	2,40	4,10	4,10	4,20	6,00	0,011	0,16	0,10	0,020	0,04	0,08
0,8	3°	4,00	4,30	4,30	4,40	6,30	0,010	0,16	0,09	0,018	0,04	0,06
0,8	2°	5,60	4,50	4,50	4,60	6,60	0,009	0,16	0,07	0,016	0,04	0,05

Abmessungen in mm  
Dimensions in mm

# Schaftfräser Vollradius Mikro

## Ball Nose End Mill Micro



### DSKMH

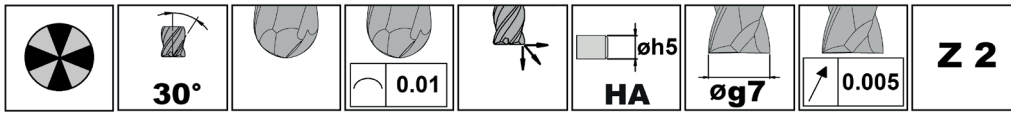

B

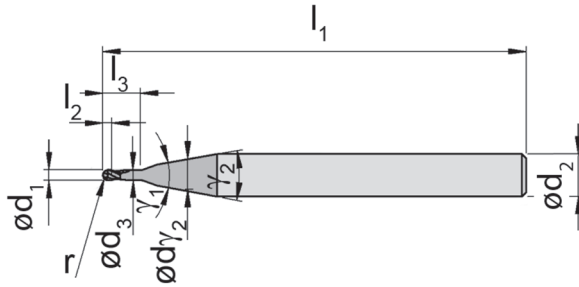

Bis Ø 3 mm vormontiert lieferbar für Toodle Schnelllaufspindel (siehe Seite D2)  
Pre-assembled available up to Ø 3 mm for Toodle high-speed spindle (see page D2)

Bestellnummer Part number	d <sub>1</sub>	r	l <sub>2</sub>	l <sub>3</sub>	d <sub>3</sub>	d <sub>2</sub>	l <sub>1</sub>	Z	γ <sub>1</sub>	γ <sub>2</sub>	d <sub>v2</sub>	TS3E
DSKMH.100.015	1,0	0,50	1,50	-	-	4	50	2	20°	-°	-	▲
DSKMH.100.030	1,0	0,50	1,50	3,0	0,95	4	50	2	40°	20°	2,0	▲
DSKMH.100.050	1,0	0,50	1,50	5,0	0,95	4	50	2	40°	20°	2,0	▲
DSKMH.100.070	1,0	0,50	1,50	7,0	0,95	4	50	2	40°	20°	2,0	▲
DSKMH.120.015	1,2	0,60	1,80	-	-	4	50	2	20°	-°	-	▲
DSKMH.120.030	1,2	0,60	1,80	3,6	1,15	4	50	2	40°	20°	2,0	▲
DSKMH.120.050	1,2	0,60	1,80	6,0	1,15	4	50	2	40°	20°	2,0	▲
DSKMH.120.070	1,2	0,60	1,80	8,4	1,15	4	50	2	40°	20°	2,0	▲
DSKMH.150.015	1,5	0,75	2,25	-	-	4	50	2	20°	-°	-	▲
DSKMH.150.030	1,5	0,75	2,25	4,5	1,45	4	50	2	40°	20°	2,5	▲
DSKMH.150.050	1,5	0,75	2,25	7,5	1,45	4	50	2	40°	20°	2,5	▲
DSKMH.150.070	1,5	0,75	2,25	10,5	1,45	4	50	2	40°	20°	2,5	▲
DSKMH.200.015	2,0	1,00	3,00	-	-	4	50	2	20°	-°	-	▲
DSKMH.200.030	2,0	1,00	3,00	6,0	1,90	4	50	2	40°	20°	3,0	▲
DSKMH.200.050	2,0	1,00	3,00	10,0	1,90	4	50	2	40°	20°	3,0	▲
DSKMH.200.070	2,0	1,00	3,00	14,0	1,90	4	50	2	40°	20°	3,0	▲
DSKMH.250.015	2,5	1,25	3,75	-	-	4	50	2	20°	-°	-	▲
DSKMH.250.030	2,5	1,25	3,75	7,5	2,40	4	50	2	40°	20°	3,5	▲
DSKMH.250.050	2,5	1,25	3,75	12,5	2,40	4	50	2	40°	20°	3,5	▲
DSKMH.250.070	2,5	1,25	3,75	17,5	2,40	4	50	2	40°	20°	3,5	▲
DSKMH.300.015	3,0	1,50	4,50	-	-	4	50	2	20°	-°	-	▲
DSKMH.300.030	3,0	1,50	4,50	9,0	2,90	4	50	2	40°	20°	3,5	▲
DSKMH.300.050	3,0	1,50	4,50	15,0	2,90	4	50	2	40°	20°	3,5	▲
DSKMH.300.070	3,0	1,50	4,50	21,0	2,90	4	60	2	40°	20°	3,5	▲

▲ ab Lager / on stock Δ 4 Wochen / 4 weeks x auf Anfrage / upon request

● empfohlen / recommended

o bedingt einsetzbar / alternative recommendation

- nicht geeignet / not suitable

■ unbeschichtete HM-Sorten / uncoated grades

■ beschichtete HM-Sorten / coated grades

■ bestückt/Cermet / brazed/Cermet

Abmessungen in mm

Dimensions in mm

P	-
M	-
K	-
N	-
S	-
H	•



HM-Sorten  
Carbide grades

# Schnittdaten DSKMH Ø 1 - 3 mm



## Cutting Data DST Ø 1 - 3 mm





### Konventionelles Fräsen / Conventional milling

		
	vc = m/min	vc = m/min
H1.1	120	150
H1.2	100	130
H1.3	80	100
H1.4	70	90

### HSC Fräsen / HSC milling

		
	vc = m/min	vc = m/min
H1.1	180	220
H1.2	160	190
H1.3	140	170
H1.4	120	140

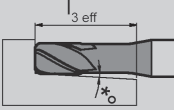
B

d <sub>1</sub>												
		0°	0,5°	1°	2°	3°	f <sub>z</sub>	a <sub>e</sub>	a <sub>p</sub>	f <sub>z</sub>	a <sub>e</sub>	a <sub>p</sub>
1,0	5°	1,50	4,70	4,70	4,80	6,90	0,013	0,20	0,15	0,024	0,05	0,10
1,0	4°	3,00	4,90	4,90	5,00	7,20	0,013	0,20	0,13	0,024	0,05	0,10
1,0	3°	5,00	5,10	5,10	5,20	7,50	0,012	0,20	0,11	0,021	0,05	0,08
1,0	2°	7,00	5,30	5,30	5,40	7,80	0,011	0,20	0,09	0,019	0,05	0,06
1,2	5°	1,80	2,00	2,10	2,30	2,60	0,016	0,24	0,18	0,028	0,06	0,12
1,2	4°	3,60	3,90	4,00	4,20	4,40	0,016	0,24	0,16	0,028	0,06	0,12
1,2	3°	6,00	6,30	6,50	6,80	7,20	0,014	0,24	0,13	0,025	0,06	0,10
1,2	2°	8,40	8,80	9,00	9,50	10,00	0,012	0,24	0,11	0,022	0,06	0,07
1,5	5°	2,25	2,50	2,60	2,80	3,10	0,019	0,30	0,23	0,033	0,08	0,15
1,5	4°	4,50	4,80	4,90	5,10	5,40	0,019	0,30	0,20	0,033	0,08	0,15
1,5	3°	7,50	7,90	8,10	8,50	8,90	0,017	0,30	0,17	0,030	0,08	0,12
1,5	2°	10,50	11,00	11,20	11,80	12,90	0,015	0,30	0,14	0,027	0,08	0,09
2,0	5°	3,00	3,30	3,40	3,70	4,10	0,024	0,40	0,30	0,043	0,10	0,20
2,0	4°	6,00	6,40	6,50	6,80	7,20	0,024	0,40	0,26	0,043	0,10	0,20
2,0	3°	10,00	10,50	10,70	11,30	12,10	0,022	0,40	0,22	0,039	0,10	0,16
2,0	2°	14,00	14,60	14,90	14,70	17,80	0,020	0,40	0,18	0,034	0,10	0,12
2,5	5°	3,75	4,00	4,20	4,60	5,10	0,030	0,50	0,38	0,053	0,13	0,25
2,5	4°	7,50	7,90	8,10	8,50	8,90	0,030	0,50	0,33	0,053	0,13	0,25
2,5	3°	12,50	13,10	13,40	14,00	15,60	0,027	0,50	0,28	0,048	0,13	0,20
2,5	2°	17,50	18,20	18,60	20,00	∞	0,024	0,50	0,23	0,042	0,13	0,15
3,0	5°	4,50	4,80	5,00	5,50	6,00	0,036	0,60	0,45	0,063	0,15	0,30
3,0	4°	9,00	9,40	9,70	10,30	∞	0,036	0,60	0,39	0,063	0,15	0,30
3,0	3°	15,00	15,60	16,00	∞	∞	0,032	0,60	0,33	0,056	0,15	0,24
3,0	2°	21,00	21,80	22,60	∞	∞	0,029	0,60	0,27	0,050	0,15	0,18

Abmessungen in mm  
Dimensions in mm



# Schaftfräser Vollradius

## Ball Nose End Mill



### DSKH



B

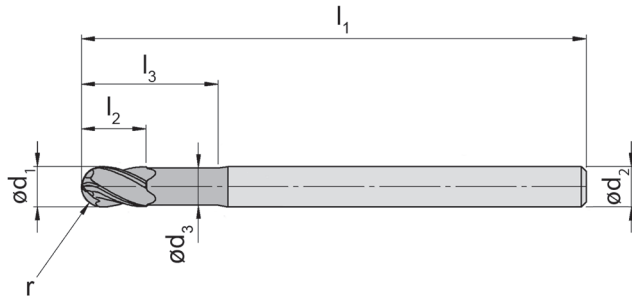

Bestellnummer Part number	d <sub>1</sub>	r	l <sub>2</sub>	l <sub>3</sub>	d <sub>3</sub>	d <sub>2</sub>	l <sub>1</sub>	Z	γ	TS3E
DSKH.2.040.015	4	2,0	6,0	6,0	-	6	64	2	20°	▲
DSKH.2.040.030	4	2,0	6,0	12,0	3,8	6	64	2	20°	▲
DSKH.2.040.050	4	2,0	6,0	20,0	3,8	6	64	2	20°	▲
DSKH.2.040.070	4	2,0	6,0	28,0	3,8	6	64	2	20°	▲
DSKH.2.050.015	5	2,5	7,5	7,5	-	6	64	2	20°	▲
DSKH.2.050.030	5	2,5	7,5	15,0	4,7	6	64	2	20°	▲
DSKH.2.050.050	5	2,5	7,5	25,0	4,7	6	64	2	20°	▲
DSKH.2.050.070	5	2,5	7,5	35,0	4,7	6	78	2	20°	▲
DSKH.2.060.015	6	3,0	9,0	9,0	-	6	64	2	-°	▲
DSKH.2.060.030	6	3,0	9,0	18,0	5,7	6	64	2	-°	▲
DSKH.2.060.050	6	3,0	9,0	30,0	5,7	6	78	2	-°	▲
DSKH.2.060.070	6	3,0	9,0	42,0	5,7	6	78	2	-°	▲
DSKH.2.080.015	8	4,0	12,0	12,0	-	8	64	2	-°	▲
DSKH.2.080.030	8	4,0	12,0	24,0	7,6	8	64	2	-°	▲
DSKH.2.080.050	8	4,0	12,0	40,0	7,6	8	78	2	-°	▲
DSKH.2.080.070	8	4,0	12,0	56,0	7,6	8	100	2	-°	▲
DSKH.2.100.015	10	5,0	15,0	15,0	-	10	78	2	-°	▲
DSKH.2.100.030	10	5,0	15,0	30,0	9,6	10	78	2	-°	▲
DSKH.2.100.050	10	5,0	15,0	50,0	9,6	10	100	2	-°	▲
DSKH.2.100.070	10	5,0	15,0	70,0	9,6	10	120	2	-°	▲
DSKH.2.120.015	12	6,0	18,0	18,0	-	12	78	2	-°	▲
DSKH.2.120.030	12	6,0	18,0	36,0	11,6	12	100	2	-°	▲
DSKH.2.120.050	12	6,0	18,0	60,0	11,6	12	120	2	-°	▲
DSKH.2.120.070	12	6,0	18,0	84,0	11,6	12	140	2	-°	▲

▲ ab Lager / on stock Δ 4 Wochen / 4 weeks x auf Anfrage / upon request

● empfohlen / recommended

o bedingt einsetzbar / alternative recommendation

- nicht geeignet / not suitable

■ unbeschichtete HM-Sorten / uncoated grades

■ beschichtete HM-Sorten / coated grades

■ bestückt/Cermet / brazed/Cermet

Abmessungen in mm

Dimensions in mm

P	-
M	-
K	-
N	-
S	-
H	●



HM-Sorten  
Carbide grades

# Schnittdaten DSKH Ø 4 - 12 mm



## Cutting Data DST Ø 4 - 12 mm

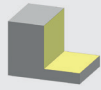

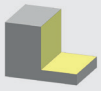

### Konventionelles Fräsen / Conventional milling

		
	vc = m/min	vc = m/min
H1.1	120	150
H1.2	100	130
H1.3	80	100
H1.4	70	90

### HSC Fräsen / HSC milling

		
	vc = m/min	vc = m/min
H1.1	180	220
H1.2	160	190
H1.3	140	170
H1.4	120	140

B

d <sub>1</sub>							
		f <sub>z</sub>	a <sub>e</sub>	a <sub>p</sub>	f <sub>z</sub>	a <sub>e</sub>	a <sub>p</sub>
4	5°	0,013	0,20	0,15	0,024	0,05	0,10
4	4°	0,013	0,20	0,13	0,024	0,05	0,10
4	3°	0,012	0,20	0,11	0,021	0,05	0,08
4	2°	0,011	0,20	0,09	0,019	0,05	0,06
5	5°	0,016	0,24	0,18	0,028	0,06	0,12
5	4°	0,016	0,24	0,16	0,028	0,06	0,12
5	3°	0,014	0,24	0,13	0,025	0,06	0,10
5	2°	0,012	0,24	0,11	0,022	0,06	0,07
6	5°	0,019	0,30	0,23	0,033	0,08	0,15
6	4°	0,019	0,30	0,20	0,033	0,08	0,15
6	3°	0,017	0,30	0,17	0,030	0,08	0,12
6	2°	0,015	0,30	0,14	0,027	0,08	0,09
8	5°	0,024	0,40	0,30	0,043	0,10	0,20
8	4°	0,024	0,40	0,26	0,043	0,10	0,20
8	3°	0,022	0,40	0,22	0,039	0,10	0,16
8	2°	0,020	0,40	0,18	0,034	0,10	0,12
10	5°	0,030	0,50	0,38	0,053	0,13	0,25
10	4°	0,030	0,50	0,33	0,053	0,13	0,25
10	3°	0,027	0,50	0,28	0,048	0,13	0,20
10	2°	0,024	0,50	0,23	0,042	0,13	0,15
12	5°	0,036	0,60	0,45	0,063	0,15	0,30
12	4°	0,036	0,60	0,39	0,063	0,15	0,30
12	3°	0,032	0,60	0,33	0,056	0,15	0,24
12	2°	0,029	0,60	0,27	0,050	0,15	0,18

Abmessungen in mm  
Dimensions in mm

# Schaftfräser Vollradius

Ball Nose End Mill



## DSKH

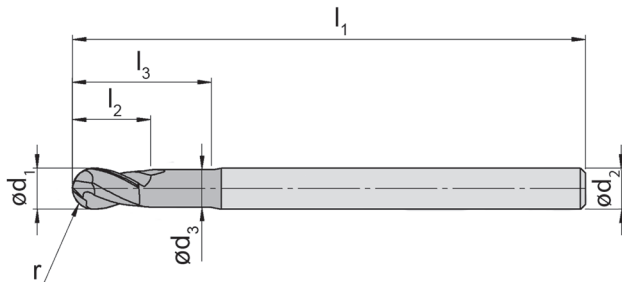

B

Bestellnummer Part number	d <sub>1</sub>	r	l <sub>2</sub>	l <sub>3</sub>	d <sub>3</sub>	d <sub>2</sub>	l <sub>1</sub>	Z	γ	TS3E
DSKH.4.040.015	4	2,0	6,0	6,0	-	6	64	4	20°	▲
DSKH.4.040.030	4	2,0	6,0	12,0	3,8	6	64	4	20°	▲
DSKH.4.040.050	4	2,0	6,0	20,0	3,8	6	64	4	20°	▲
DSKH.4.040.070	4	2,0	6,0	28,0	3,8	6	64	4	20°	▲
DSKH.4.050.015	5	2,5	7,5	7,5	-	6	64	4	20°	▲
DSKH.4.050.030	5	2,5	7,5	15,0	4,7	6	64	4	20°	▲
DSKH.4.050.050	5	2,5	7,5	25,0	4,7	6	64	4	20°	▲
DSKH.4.050.070	5	2,5	7,5	35,0	4,7	6	64	4	20°	▲
DSKH.4.060.015	6	3,0	9,0	9,0	-	6	64	4	-°	▲
DSKH.4.060.030	6	3,0	9,0	18,0	5,7	6	64	4	-°	▲
DSKH.4.060.050	6	3,0	9,0	30,0	5,7	6	78	4	-°	▲
DSKH.4.060.070	6	3,0	9,0	42,0	5,7	6	78	4	-°	▲
DSKH.4.080.015	8	4,0	12,0	12,0	-	8	64	4	-°	▲
DSKH.4.080.030	8	4,0	12,0	24,0	7,6	8	64	4	-°	▲
DSKH.4.080.050	8	4,0	12,0	40,0	7,6	8	78	4	-°	▲
DSKH.4.080.070	8	4,0	12,0	56,0	7,6	8	100	4	-°	▲
DSKH.4.100.015	10	5,0	15,0	15,0	-	10	78	4	-°	▲
DSKH.4.100.030	10	5,0	15,0	30,0	9,6	10	78	4	-°	▲
DSKH.4.100.050	10	5,0	15,0	50,0	9,6	10	100	4	-°	▲
DSKH.4.100.070	10	5,0	15,0	70,0	9,6	10	120	4	-°	▲
DSKH.4.120.015	12	6,0	18,0	18,0	-	12	78	4	-°	▲
DSKH.4.120.030	12	6,0	18,0	36,0	11,6	12	100	4	-°	▲
DSKH.4.120.050	12	6,0	18,0	60,0	11,6	12	120	4	-°	▲
DSKH.4.120.070	12	6,0	18,0	84,0	11,6	12	140	4	-°	▲

▲ ab Lager / on stock Δ 4 Wochen / 4 weeks x auf Anfrage / upon request

● empfohlen / recommended

o bedingt einsetzbar / alternative recommendation

- nicht geeignet / not suitable

■ unbeschichtete HM-Sorten / uncoated grades

■ beschichtete HM-Sorten / coated grades

■ bestückt/Cermet / brazed/Cermet

Abmessungen in mm

Dimensions in mm

P	-
M	-
K	-
N	-
S	-
H	●



HM-Sorten  
Carbide grades

# Schnittdaten DSKH Ø 4 - 12 mm



## Cutting Data DST Ø 4 - 12 mm





### Konventionelles Fräsen / Conventional milling

		
	vc = m/min	vc = m/min
H1.1	120	150
H1.2	100	130
H1.3	80	100
H1.4	70	90

### HSC Fräsen / HSC milling

		
	vc = m/min	vc = m/min
H1.1	180	220
H1.2	160	190
H1.3	140	170
H1.4	120	140

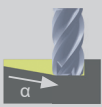
B

d <sub>1</sub>							
		f <sub>z</sub>	a <sub>e</sub>	a <sub>p</sub>	f <sub>z</sub>	a <sub>e</sub>	a <sub>p</sub>
4	5°	0,023	0,80	0,60	0,035	0,20	0,40
4	4°	0,023	0,80	0,52	0,035	0,20	0,40
4	3°	0,021	0,80	0,44	0,032	0,20	0,32
4	2°	0,019	0,80	0,36	0,028	0,20	0,24
5	5°	0,035	1,00	0,75	0,055	0,25	0,50
5	4°	0,035	1,00	0,65	0,055	0,25	0,50
5	3°	0,031	1,00	0,55	0,049	0,25	0,40
5	2°	0,028	1,00	0,45	0,044	0,25	0,30
6	5°	0,046	1,20	0,90	0,074	0,30	0,60
6	4°	0,046	1,20	0,78	0,074	0,30	0,60
6	3°	0,041	1,20	0,66	0,067	0,30	0,48
6	2°	0,037	1,20	0,54	0,059	0,30	0,36
8	5°	0,068	1,60	1,20	0,113	0,40	0,80
8	4°	0,068	1,60	1,04	0,113	0,40	0,80
8	3°	0,061	1,60	0,88	0,102	0,40	0,64
8	2°	0,055	1,60	0,72	0,090	0,40	0,48
10	5°	0,090	2,00	1,50	0,152	0,50	1,00
10	4°	0,090	2,00	1,30	0,152	0,50	1,00
10	3°	0,081	2,00	1,10	0,137	0,50	0,80
10	2°	0,072	2,00	0,90	0,121	0,50	0,60
12	5°	0,113	2,40	1,80	0,191	0,60	1,20
12	4°	0,113	2,40	1,56	0,191	0,60	1,20
12	3°	0,102	2,40	1,32	0,172	0,60	0,96
12	2°	0,090	2,40	1,08	0,153	0,60	0,72

Abmessungen in mm  
Dimensions in mm

### DSTMH

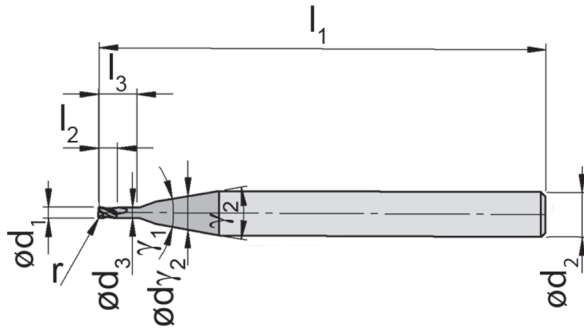
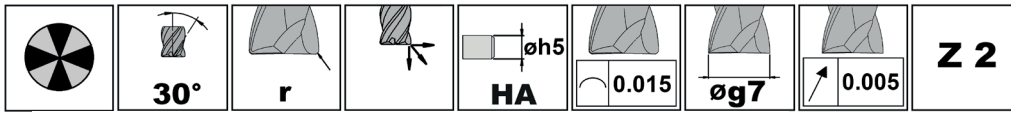

Bis Ø 3 mm vormontiert lieferbar für Toodle Schnelllaufspindel (siehe Seite D2)  
Pre-assembled available up to Ø 3 mm for Toodle high-speed spindle (see page D2)

Bestellnummer Part number	d <sub>1</sub>	r	l <sub>2</sub>	l <sub>3</sub>	d <sub>3</sub>	d <sub>2</sub>	l <sub>1</sub>	Z	γ <sub>1</sub>	γ <sub>2</sub>	d <sub>y2</sub>	TS3E
DSTMH.010.000.015	0,1	0	0,15	0,15	-	4	50	2	20°	-°	-	▲
DSTMH.010.000.030	0,1	0	0,15	0,30	0,084	4	50	2	20°	-°	-	▲
DSTMH.020.000.015	0,2	0	0,30	0,30	-	4	50	2	20°	-°	-	▲
DSTMH.020.000.030	0,2	0	0,30	0,60	0,180	4	50	2	40°	20°	1,5	▲
DSTMH.020.000.050	0,2	0	0,30	1,00	0,180	4	50	2	40°	20°	1,5	▲
DSTMH.030.005.015	0,3	0,05	0,45	0,45	-	4	50	2	20°	-°	-	▲
DSTMH.030.005.030	0,3	0,05	0,45	0,90	0,280	4	50	2	40°	20°	1,5	▲
DSTMH.030.005.050	0,3	0,05	0,45	1,50	0,280	4	50	2	40°	20°	1,5	▲
DSTMH.040.005.015	0,4	0,05	0,60	0,60	-	4	50	2	20°	-°	-	▲
DSTMH.040.005.030	0,4	0,05	0,60	1,20	0,380	4	50	2	40°	20°	1,5	▲
DSTMH.040.005.050	0,4	0,05	0,60	2,00	0,380	4	50	2	40°	20°	1,5	▲
DSTMH.050.005.015	0,5	0,05	0,75	0,75	-	4	50	2	20°	-°	-	▲
DSTMH.050.005.030	0,5	0,05	0,75	1,50	0,470	4	50	2	40°	20°	1,5	▲
DSTMH.050.005.050	0,5	0,05	0,75	2,50	0,470	4	50	2	40°	20°	1,5	▲
DSTMH.050.005.070	0,5	0,05	0,75	3,50	0,470	4	50	2	40°	20°	1,5	▲
DSTMH.050.010.015	0,5	0,10	0,75	0,75	-	4	50	2	20°	-°	-	▲
DSTMH.050.010.030	0,5	0,10	0,75	1,50	0,470	4	50	2	40°	20°	1,5	▲
DSTMH.050.010.050	0,5	0,10	0,75	2,50	0,470	4	50	2	40°	20°	1,5	▲
DSTMH.050.010.070	0,5	0,10	0,75	3,50	0,470	4	50	2	40°	20°	1,5	▲
DSTMH.060.005.015	0,6	0,05	0,90	0,90	-	4	50	2	20°	-°	-	▲
DSTMH.060.005.030	0,6	0,05	0,90	1,80	0,560	4	50	2	40°	20°	1,5	▲
DSTMH.060.005.050	0,6	0,05	0,90	3,00	0,560	4	50	2	40°	20°	1,5	▲
DSTMH.060.005.070	0,6	0,05	0,90	4,20	0,560	4	50	2	40°	20°	1,5	▲
DSTMH.060.010.015	0,6	0,10	0,90	0,90	-	4	50	2	20°	-°	-	▲
DSTMH.060.010.030	0,6	0,10	0,90	1,80	0,560	4	50	2	40°	20°	1,5	▲
DSTMH.060.010.050	0,6	0,10	0,90	3,00	0,560	4	50	2	40°	20°	1,5	▲
DSTMH.060.010.070	0,6	0,10	0,90	4,20	0,560	4	50	2	40°	20°	1,5	▲

▲ ab Lager / on stock Δ 4 Wochen / 4 weeks x auf Anfrage / upon request

● empfohlen / recommended

o bedingt einsetzbar / alternative recommendation

- nicht geeignet / not suitable

■ unbeschichtete HM-Sorten / uncoated grades

■ beschichtete HM-Sorten / coated grades

■ bestückt/Cermet / brazed/Cermet

Abmessungen in mm

Dimensions in mm

P	-
M	-
K	-
N	-
S	-
H	●



HM-Sorten  
Carbide grades

# Schnittdaten DSTMH Ø 0,1 - 0,6 mm



## Cutting Data DSTMH Ø 0,1 - 0,6 mm



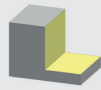

### Konventionelles Fräsen / Conventional milling

		
	vc = m/min	vc = m/min
H1.1	120	150
H1.2	100	130
H1.3	80	100
H1.4	70	90

### HSC Fräsen / HSC milling

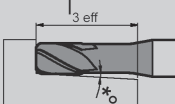
		
	vc = m/min	vc = m/min
H1.1	180	220
H1.2	160	190
H1.3	140	170
H1.4	120	140

d <sub>1</sub>												
		0°	0,5°	1°	2°	3°	f <sub>z</sub>	a <sub>e</sub>	a <sub>p</sub>	f <sub>z</sub>	a <sub>e</sub>	a <sub>p</sub>
0,1	5°	0,15	0,30	0,30	0,40	0,40	0,003	0,02	0,02	0,005	0,01	0,01
0,1	4°	0,30	0,50	0,50	0,60	0,70	0,003	0,02	0,01	0,005	0,01	0,01
0,2	5°	0,30	0,50	0,50	0,60	0,70	0,004	0,04	0,03	0,007	0,02	0,02
0,2	4°	0,60	0,70	0,70	0,80	0,90	0,004	0,04	0,03	0,007	0,02	0,02
0,2	3°	1,00	1,10	1,20	1,30	1,40	0,004	0,04	0,02	0,006	0,02	0,02
0,3	5°	0,45	0,60	0,70	0,80	0,90	0,005	0,06	0,05	0,008	0,02	0,03
0,3	4°	0,90	1,00	1,10	1,20	1,20	0,005	0,06	0,04	0,008	0,02	0,03
0,3	3°	1,50	1,60	1,70	1,80	1,90	0,005	0,06	0,03	0,007	0,02	0,02
0,4	5°	0,60	0,80	0,80	0,90	1,10	0,007	0,08	0,06	0,010	0,03	0,04
0,4	4°	1,20	1,40	1,40	1,50	1,60	0,007	0,08	0,05	0,010	0,03	0,04
0,4	3°	2,00	2,20	2,30	2,40	2,50	0,006	0,08	0,04	0,009	0,03	0,03
0,5	5°	0,75	1,00	1,00	1,10	1,30	0,008	0,10	0,08	0,011	0,04	0,05
0,5	4°	1,50	1,70	1,70	1,90	2,00	0,008	0,10	0,07	0,011	0,04	0,05
0,5	3°	2,50	2,70	2,80	3,00	3,10	0,007	0,10	0,06	0,010	0,04	0,04
0,5	2°	3,50	3,70	3,90	4,10	4,30	0,006	0,10	0,05	0,009	0,04	0,03
0,5	5°	0,75	1,00	1,00	1,10	1,30	0,008	0,10	0,08	0,011	0,04	0,05
0,5	4°	1,50	1,70	1,70	1,90	2,00	0,008	0,10	0,07	0,011	0,04	0,05
0,5	3°	2,50	2,70	2,80	3,00	3,10	0,007	0,10	0,06	0,010	0,04	0,04
0,5	2°	3,50	3,70	3,90	4,10	4,30	0,006	0,10	0,05	0,009	0,04	0,03
0,6	5°	0,90	1,10	1,20	1,30	1,50	0,009	0,12	0,09	0,013	0,05	0,06
0,6	4°	1,80	2,00	2,10	2,20	2,30	0,009	0,12	0,08	0,013	0,05	0,06
0,6	3°	3,00	3,30	3,40	3,50	3,70	0,008	0,12	0,07	0,012	0,05	0,05
0,6	2°	4,20	4,50	4,60	4,90	5,10	0,007	0,12	0,05	0,010	0,05	0,04
0,6	5°	0,90	1,10	1,20	1,30	1,50	0,009	0,12	0,09	0,013	0,05	0,06
0,6	4°	1,80	2,00	2,10	2,20	2,30	0,009	0,12	0,08	0,013	0,05	0,06
0,6	3°	3,00	3,30	3,30	3,50	3,70	0,008	0,12	0,07	0,012	0,05	0,05
0,6	2°	4,20	4,50	4,60	4,90	5,10	0,007	0,12	0,05	0,010	0,05	0,04

Abmessungen in mm  
Dimensions in mm

B

### DSTMH

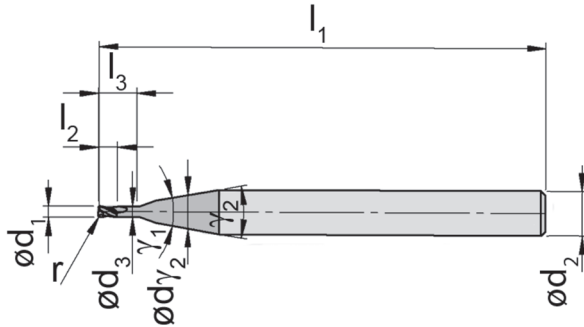
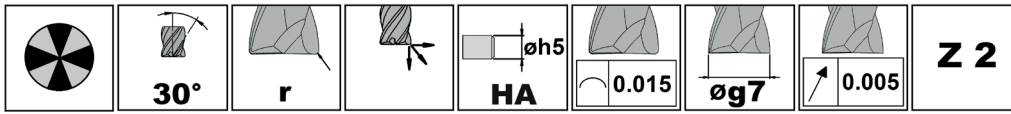

Bis Ø 3 mm vormontiert lieferbar für Toodle Schnelllaufspindel (siehe Seite D2)  
Pre-assembled available up to Ø 3 mm for Toodle high-speed spindle (see page D2)

Bestellnummer Part number	d <sub>1</sub>	r	l <sub>2</sub>	l <sub>3</sub>	d <sub>3</sub>	d <sub>2</sub>	l <sub>1</sub>	Z	γ <sub>1</sub>	γ <sub>2</sub>	d <sub>v2</sub>	TS3E
DSTMH.080.005.015	0,8	0,05	1,2	1,2	-	4	50	2	20°	-°	-	▲
DSTMH.080.005.030	0,8	0,05	1,2	2,4	0,75	4	50	2	40°	20°	1,5	▲
DSTMH.080.005.050	0,8	0,05	1,2	4,0	0,75	4	50	2	40°	20°	1,5	▲
DSTMH.080.005.070	0,8	0,05	1,2	5,6	0,75	4	50	2	40°	20°	1,5	▲
DSTMH.080.010.015	0,8	0,10	1,2	1,2	-	4	50	2	20°	-°	-	▲
DSTMH.080.010.030	0,8	0,10	1,2	2,4	0,75	4	50	2	40°	20°	1,5	▲
DSTMH.080.010.050	0,8	0,10	1,2	4,0	0,75	4	50	2	40°	20°	1,5	▲
DSTMH.080.010.070	0,8	0,10	1,2	5,6	0,75	4	50	2	40°	20°	1,5	▲
DSTMH.100.005.015	1,0	0,05	1,5	1,5	-	4	50	2	20°	-°	-	▲
DSTMH.100.005.030	1,0	0,05	1,5	3,0	0,95	4	50	2	40°	20°	2,0	▲
DSTMH.100.005.050	1,0	0,05	1,5	5,0	0,95	4	50	2	40°	20°	2,0	▲
DSTMH.100.005.070	1,0	0,05	1,5	7,0	0,95	4	50	2	40°	20°	2,0	▲
DSTMH.100.010.015	1,0	0,10	1,5	1,5	-	4	50	2	20°	-°	-	▲
DSTMH.100.010.030	1,0	0,10	1,5	3,0	0,95	4	50	2	40°	20°	2,0	▲
DSTMH.100.010.050	1,0	0,10	1,5	5,0	0,95	4	50	2	40°	20°	2,0	▲
DSTMH.100.010.070	1,0	0,10	1,5	7,0	0,95	4	50	2	40°	20°	2,0	▲
DSTMH.120.010.015	1,2	0,10	1,8	1,8	-	4	50	2	20°	-°	-	▲
DSTMH.120.010.030	1,2	0,10	1,8	3,6	1,15	4	50	2	40°	20°	2,0	▲
DSTMH.120.010.050	1,2	0,10	1,8	6,0	1,15	4	50	2	40°	20°	2,0	▲
DSTMH.120.010.070	1,2	0,10	1,8	8,4	1,15	4	50	2	40°	20°	2,0	▲

▲ ab Lager / on stock   Δ 4 Wochen / 4 weeks   x auf Anfrage / upon request

● empfohlen / recommended

o bedingt einsetzbar / alternative recommendation

- nicht geeignet / not suitable

■ unbeschichtete HM-Sorten / uncoated grades

■ beschichtete HM-Sorten / coated grades

■ bestückt/Cermet / brazed/Cermet

Abmessungen in mm

Dimensions in mm

P	-
M	-
K	-
N	-
S	-
H	•



HM-Sorten  
Carbide grades

# Schnittdaten DSTMH Ø 0,8 - 1,2 mm



## Cutting Data DSTMH Ø 0,8 - 1,2 mm



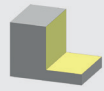

### Konventionelles Fräsen / Conventional milling

		
	vc = m/min	vc = m/min
H1.1	120	150
H1.2	100	130
H1.3	80	100
H1.4	70	90

### HSC Fräsen / HSC milling

		
	vc = m/min	vc = m/min
H1.1	180	220
H1.2	160	190
H1.3	140	170
H1.4	120	140

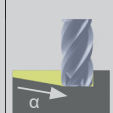
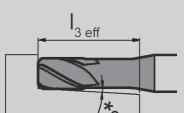
B

d <sub>1</sub>												
		0°	0,5°	1°	2°	3°	f <sub>z</sub>	a <sub>e</sub>	a <sub>p</sub>	f <sub>z</sub>	a <sub>e</sub>	a <sub>p</sub>
0,8	5°	1,20	1,40	1,50	1,70	1,90	0,011	0,16	0,12	0,016	0,06	0,08
0,8	4°	2,40	2,70	2,70	2,90	3,00	0,011	0,16	0,10	0,016	0,06	0,08
0,8	5°	4,00	4,30	4,40	4,70	4,90	0,010	0,16	0,09	0,015	0,06	0,06
0,8	4°	5,60	5,90	6,10	6,40	6,80	0,009	0,16	0,07	0,013	0,06	0,05
0,8	3°	1,20	1,40	1,50	1,70	1,90	0,011	0,16	0,12	0,016	0,06	0,08
0,8	5°	2,40	2,60	2,70	2,90	3,00	0,011	0,16	0,10	0,016	0,06	0,08
0,8	4°	4,00	4,30	4,40	4,60	4,90	0,010	0,16	0,09	0,015	0,06	0,06
0,8	3°	5,60	5,90	6,10	6,40	6,80	0,009	0,16	0,07	0,013	0,06	0,05
1,0	5°	1,50	1,70	1,80	2,10	2,40	0,013	0,20	0,15	0,019	0,08	0,10
1,0	4°	3,00	3,30	3,40	3,50	3,70	0,013	0,20	0,13	0,019	0,08	0,10
1,0	3°	5,00	5,30	5,50	5,80	6,10	0,012	0,20	0,11	0,017	0,08	0,08
1,0	5°	7,00	7,40	7,60	8,00	8,40	0,011	0,20	0,09	0,015	0,08	0,06
1,0	4°	1,50	1,70	1,80	2,10	2,30	0,013	0,20	0,15	0,019	0,08	0,10
1,0	3°	3,00	3,30	3,40	3,50	3,70	0,013	0,20	0,13	0,019	0,08	0,10
1,0	2°	5,00	5,30	5,50	5,80	6,10	0,012	0,20	0,11	0,017	0,08	0,08
1,0	5°	7,00	7,40	7,60	8,00	8,40	0,011	0,20	0,09	0,015	0,08	0,06
1,2	4°	1,80	2,10	2,20	2,40	2,70	0,016	0,24	0,18	0,022	0,09	0,12
1,2	3°	3,60	3,90	4,00	4,20	4,40	0,016	0,24	0,16	0,022	0,09	0,12
1,2	2°	6,00	6,40	6,50	6,90	7,20	0,014	0,24	0,13	0,020	0,09	0,10
1,2	5°	8,40	8,80	9,00	8,50	10,60	0,012	0,24	0,11	0,018	0,09	0,07

Abmessungen in mm  
Dimensions in mm



### DSTMH

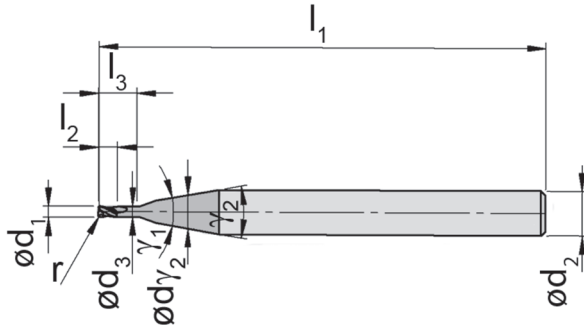
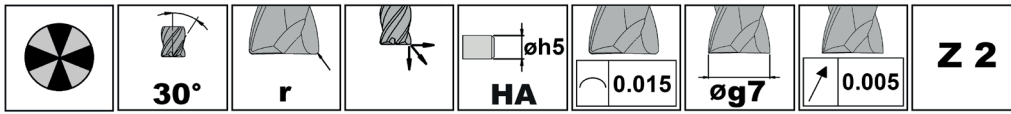

Bis Ø 3 mm vormontiert lieferbar für Toodle Schnelllaufspindel (siehe Seite D2)  
Pre-assembled available up to Ø 3 mm for Toodle high-speed spindle (see page D2)

Bestellnummer Part number	d <sub>1</sub>	r	l <sub>2</sub>	l <sub>3</sub>	d <sub>3</sub>	d <sub>2</sub>	l <sub>1</sub>	Z	γ <sub>1</sub>	γ <sub>2</sub>	d <sub>v2</sub>	TS3E
DSTMH.150.010.015	1,5	0,1	2,25	2,25	-	4	50	2	20°	-°	-	▲
DSTMH.150.010.030	1,5	0,1	2,25	4,50	1,45	4	50	2	40°	20°	2,5	▲
DSTMH.150.010.050	1,5	0,1	2,25	7,50	1,45	4	50	2	40°	20°	2,5	▲
DSTMH.150.010.070	1,5	0,1	2,25	10,50	1,45	4	50	2	40°	20°	2,5	▲
DSTMH.150.020.015	1,5	0,2	2,25	2,25	-	4	50	2	20°	-°	-	▲
DSTMH.150.020.030	1,5	0,2	2,25	4,50	1,45	4	50	2	40°	20°	2,5	▲
DSTMH.150.020.050	1,5	0,2	2,25	7,50	1,45	4	50	2	40°	20°	2,5	▲
DSTMH.150.020.070	1,5	0,2	2,25	10,50	1,45	4	50	2	40°	20°	2,5	▲
DSTMH.150.050.015	1,5	0,5	2,25	2,25	-	4	50	2	20°	-°	-	▲
DSTMH.150.050.030	1,5	0,5	2,25	4,50	1,45	4	50	2	40°	20°	2,5	▲
DSTMH.150.050.050	1,5	0,5	2,25	7,50	1,45	4	50	2	40°	20°	2,5	▲
DSTMH.150.050.070	1,5	0,5	2,25	10,50	1,45	4	50	2	40°	20°	2,5	▲
DSTMH.200.010.015	2,0	0,1	3,00	3,00	-	4	50	2	20°	-°	-	▲
DSTMH.200.010.030	2,0	0,1	3,00	6,00	1,90	4	50	2	40°	20°	3,0	▲
DSTMH.200.010.050	2,0	0,1	3,00	10,00	1,90	4	50	2	40°	20°	3,0	▲
DSTMH.200.010.070	2,0	0,1	3,00	14,00	1,90	4	50	2	40°	20°	3,0	▲
DSTMH.200.020.015	2,0	0,2	3,00	3,00	-	4	50	2	20°	-°	-	▲
DSTMH.200.020.030	2,0	0,2	3,00	6,00	1,90	4	50	2	40°	20°	3,0	▲
DSTMH.200.020.050	2,0	0,2	3,00	10,00	1,90	4	50	2	40°	20°	3,0	▲
DSTMH.200.020.070	2,0	0,2	3,00	14,00	1,90	4	50	2	40°	20°	3,0	▲
DSTMH.200.050.015	2,0	0,5	3,00	3,00	-	4	50	2	20°	-°	-	▲
DSTMH.200.050.030	2,0	0,5	3,00	6,00	1,90	4	50	2	40°	20°	3,0	▲
DSTMH.200.050.050	2,0	0,5	3,00	10,00	1,90	4	50	2	40°	20°	3,0	▲
DSTMH.200.050.070	2,0	0,5	3,00	14,00	1,90	4	50	2	40°	20°	3,0	▲

▲ ab Lager / on stock Δ 4 Wochen / 4 weeks x auf Anfrage / upon request

● empfohlen / recommended

o bedingt einsetzbar / alternative recommendation

- nicht geeignet / not suitable

■ unbeschichtete HM-Sorten / uncoated grades

■ beschichtete HM-Sorten / coated grades

■ bestückt/Cermet / brazed/Cermet

Abmessungen in mm

Dimensions in mm

P	-
M	-
K	-
N	-
S	-
H	•



HM-Sorten  
Carbide grades

# Schnittdaten DSTMH Ø 1,5 - 2 mm



## Cutting Data DSTMH Ø 1,5 - 2 mm



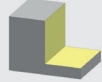

### Konventionelles Fräsen / Conventional milling

		
	vc = m/min	vc = m/min
H1.1	120	150
H1.2	100	130
H1.3	80	100
H1.4	70	90

### HSC Fräsen / HSC milling

		
	vc = m/min	vc = m/min
H1.1	180	220
H1.2	160	190
H1.3	140	170
H1.4	120	140

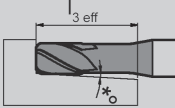
B

d <sub>1</sub>												
		0°	0,5°	1°	2°	3°	f <sub>z</sub>	a <sub>e</sub>	a <sub>p</sub>	f <sub>z</sub>	a <sub>e</sub>	a <sub>p</sub>
1,5	5°	2,25	2,50	2,70	3,00	3,40	0,019	0,30	0,23	0,027	0,11	0,15
1,5	4°	4,50	4,80	4,90	5,20	5,50	0,019	0,30	0,20	0,027	0,11	0,15
1,5	3°	7,50	7,90	8,10	8,50	9,00	0,017	0,30	0,17	0,025	0,11	0,12
1,5	2°	10,50	11,00	11,20	11,80	13,10	0,015	0,30	0,14	0,022	0,11	0,09
1,5	5°	2,25	2,50	2,70	3,00	3,40	0,019	0,30	0,23	0,027	0,11	0,15
1,5	4°	4,50	4,80	4,90	5,20	5,50	0,019	0,30	0,20	0,027	0,11	0,15
1,5	3°	7,50	7,90	8,10	8,50	9,00	0,017	0,30	0,17	0,025	0,11	0,12
1,5	2°	10,50	11,00	11,20	11,80	13,10	0,015	0,30	0,14	0,022	0,11	0,09
1,5	5°	2,25	2,50	2,60	2,90	3,20	0,019	0,30	0,23	0,027	0,11	0,15
1,5	4°	4,50	4,80	4,90	5,20	5,40	0,019	0,30	0,20	0,027	0,11	0,15
1,5	3°	7,50	7,90	8,10	8,50	8,90	0,017	0,30	0,17	0,025	0,11	0,12
1,5	2°	10,50	11,00	11,20	11,80	13,00	0,015	0,30	0,14	0,022	0,11	0,09
2,0	5°	3,00	3,30	3,50	3,90	4,50	0,024	0,40	0,30	0,035	0,15	0,20
2,0	4°	6,00	6,40	6,60	6,90	7,30	0,024	0,40	0,26	0,035	0,15	0,20
2,0	3°	10,00	10,50	10,80	11,30	12,50	0,022	0,40	0,22	0,032	0,15	0,16
2,0	2°	14,00	14,60	15,00	16,00	18,20	0,020	0,40	0,18	0,028	0,15	0,12
2,0	5°	3,00	3,30	3,50	3,90	4,40	0,024	0,40	0,30	0,035	0,15	0,20
2,0	4°	6,00	6,40	6,60	6,90	7,30	0,024	0,40	0,26	0,035	0,15	0,20
2,0	3°	10,00	10,50	10,80	11,30	12,50	0,022	0,40	0,22	0,032	0,15	0,16
2,0	2°	14,00	14,60	15,00	15,90	18,20	0,020	0,40	0,18	0,028	0,15	0,12
2,0	5°	3,00	3,30	3,50	3,80	4,30	0,024	0,40	0,30	0,035	0,15	0,20
2,0	4°	6,00	6,40	6,60	6,90	7,30	0,024	0,40	0,26	0,035	0,15	0,20
2,0	3°	10,00	10,50	10,80	11,30	12,30	0,022	0,40	0,22	0,032	0,15	0,16
2,0	2°	14,00	14,60	15,00	15,90	18,00	0,020	0,40	0,18	0,028	0,15	0,12

Abmessungen in mm  
Dimensions in mm

### DSTMH

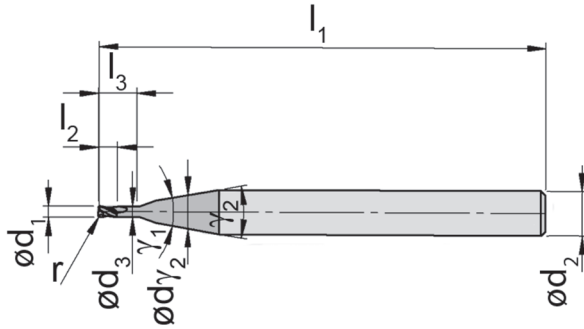
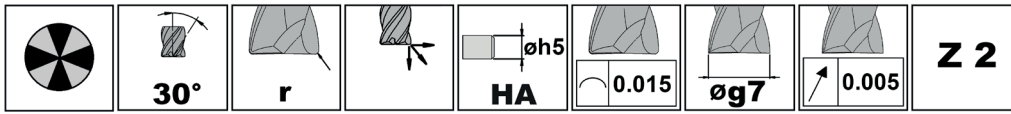

Bis Ø 3 mm vormontiert lieferbar für Toodle Schnelllaufspindel (siehe Seite D2)  
Pre-assembled available up to Ø 3 mm for Toodle high-speed spindle (see page D2)

Bestellnummer Part number	d <sub>1</sub>	r	l <sub>2</sub>	l <sub>3</sub>	d <sub>3</sub>	d <sub>2</sub>	l <sub>1</sub>	Z	γ <sub>1</sub>	γ <sub>2</sub>	d <sub>γ<sub>2</sub></sub>	TS3E
DSTMH.250.010.015	2,5	0,1	3,75	3,75	-	4	50	2	20°	-°	-	▲
DSTMH.250.010.030	2,5	0,1	3,75	7,50	2,4	4	50	2	40°	20°	3,5	▲
DSTMH.250.010.050	2,5	0,1	3,75	12,50	2,4	4	50	2	40°	20°	3,5	▲
DSTMH.250.010.070	2,5	0,1	3,75	17,50	2,4	4	50	2	40°	20°	3,5	▲
DSTMH.250.020.015	2,5	0,2	3,75	3,75	-	4	50	2	20°	-°	-	▲
DSTMH.250.020.030	2,5	0,2	3,75	7,50	2,4	4	50	2	40°	20°	3,5	▲
DSTMH.250.020.050	2,5	0,2	3,75	12,50	2,4	4	50	2	40°	20°	3,5	▲
DSTMH.250.020.070	2,5	0,2	3,75	17,50	2,4	4	50	2	40°	20°	3,5	▲
DSTMH.250.050.015	2,5	0,5	3,75	3,75	-	4	50	2	20°	-°	-	▲
DSTMH.250.050.030	2,5	0,5	3,75	7,50	2,4	4	50	2	40°	20°	3,5	▲
DSTMH.250.050.050	2,5	0,5	3,75	12,50	2,4	4	50	2	40°	20°	3,5	▲
DSTMH.250.050.070	2,5	0,5	3,75	17,50	2,4	4	50	2	40°	20°	3,5	▲
DSTMH.300.010.015	3,0	0,1	4,50	4,50	-	4	50	2	20°	-°	-	▲
DSTMH.300.010.030	3,0	0,1	4,50	9,00	2,9	4	50	2	40°	20°	3,5	▲
DSTMH.300.010.050	3,0	0,1	4,50	15,00	2,9	4	50	2	40°	20°	3,5	▲
DSTMH.300.010.070	3,0	0,1	4,50	21,00	2,9	4	60	2	40°	20°	3,5	▲
DSTMH.300.020.015	3,0	0,2	4,50	4,50	-	4	50	2	20°	-°	-	▲
DSTMH.300.020.030	3,0	0,2	4,50	9,00	2,9	4	50	2	40°	20°	3,5	▲
DSTMH.300.020.050	3,0	0,2	4,50	15,00	2,9	4	50	2	40°	20°	3,5	▲
DSTMH.300.020.070	3,0	0,2	4,50	21,00	2,9	4	60	2	40°	20°	3,5	▲
DSTMH.300.050.015	3,0	0,5	4,50	4,50	-	4	50	2	20°	-°	-	▲
DSTMH.300.050.030	3,0	0,5	4,50	9,00	2,9	4	50	2	40°	20°	3,5	▲
DSTMH.300.050.050	3,0	0,5	4,50	15,00	2,9	4	50	2	40°	20°	3,5	▲
DSTMH.300.050.070	3,0	0,5	4,50	21,00	2,9	4	60	2	40°	20°	3,5	▲
DSTMH.300.100.015	3,0	1,0	4,50	4,50	-	4	50	2	20°	-°	-	▲
DSTMH.300.100.030	3,0	1,0	4,50	9,00	2,9	4	50	2	40°	20°	3,5	▲
DSTMH.300.100.050	3,0	1,0	4,50	15,00	2,9	4	50	2	40°	20°	3,5	▲
DSTMH.300.100.070	3,0	1,0	4,50	21,00	2,9	4	60	2	40°	20°	3,5	▲

▲ ab Lager / on stock Δ 4 Wochen / 4 weeks x auf Anfrage / upon request

● empfohlen / recommended

o bedingt einsetzbar / alternative recommendation

- nicht geeignet / not suitable

■ unbeschichtete HM-Sorten / uncoated grades

■ beschichtete HM-Sorten / coated grades

■ bestückt/Cermet / brazed/Cermet



P	-
M	-
K	-
N	-
S	-
H	•

# Schnittdaten DSTMH Ø 2,5 - 3 mm



## Cutting Data DSTMH Ø 2,5 - 3 mm



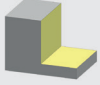

### Konventionelles Fräsen / Conventional milling

		
	vc = m/min	vc = m/min
H1.1	120	150
H1.2	100	130
H1.3	80	100
H1.4	70	90

### HSC Fräsen / HSC milling

		
	vc = m/min	vc = m/min
H1.1	180	220
H1.2	160	190
H1.3	140	170
H1.4	120	140

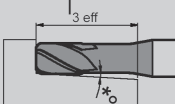
B

d <sub>1</sub>												
		0°	0,5°	1°	2°	3°	f <sub>z</sub>	a <sub>e</sub>	a <sub>p</sub>	f <sub>z</sub>	a <sub>e</sub>	a <sub>p</sub>
2,5	5°	3,75	4,10	4,30	4,90	5,50	0,030	0,50	0,38	0,043	0,19	0,25
2,5	4°	7,50	8,00	8,20	8,60	9,10	0,030	0,50	0,33	0,043	0,19	0,25
2,5	3°	12,50	13,10	13,40	14,10	∞	0,027	0,50	0,28	0,039	0,19	0,20
2,5	2°	17,50	18,20	18,70	20,30	∞	0,024	0,50	0,23	0,035	0,19	0,15
2,5	5°	3,75	4,10	4,30	4,80	5,50	0,030	0,50	0,38	0,043	0,19	0,25
2,5	4°	7,50	8,00	8,20	8,60	9,10	0,030	0,50	0,33	0,043	0,19	0,25
2,5	3°	12,50	13,10	13,40	14,10	∞	0,027	0,50	0,28	0,039	0,19	0,20
2,5	2°	17,50	18,20	18,70	20,30	∞	0,024	0,50	0,23	0,035	0,19	0,15
2,5	5°	3,75	4,10	4,30	4,80	5,40	0,030	0,50	0,38	0,043	0,19	0,25
2,5	4°	7,50	8,00	8,10	8,60	9,00	0,030	0,50	0,33	0,043	0,19	0,25
2,5	3°	12,50	13,10	13,40	14,00	∞	0,027	0,50	0,28	0,039	0,19	0,20
2,5	2°	17,50	18,20	18,60	20,20	∞	0,024	0,50	0,23	0,035	0,19	0,15
3,0	5°	4,50	4,90	5,20	5,80	6,60	0,036	0,60	0,45	0,051	0,23	0,30
3,0	4°	9,00	9,50	9,70	10,60	∞	0,036	0,60	0,39	0,051	0,23	0,30
3,0	3°	15,00	15,70	16,10	∞	∞	0,032	0,60	0,33	0,046	0,23	0,24
3,0	2°	21,00	21,80	22,80	∞	∞	0,029	0,60	0,27	0,041	0,23	0,18
3,0	5°	4,50	4,90	5,20	5,80	6,60	0,036	0,60	0,45	0,051	0,23	0,30
3,0	4°	9,00	9,50	9,70	10,60	∞	0,036	0,60	0,39	0,051	0,23	0,30
3,0	3°	15,00	15,60	16,10	∞	∞	0,032	0,60	0,33	0,046	0,23	0,24
3,0	2°	21,00	21,80	22,80	∞	∞	0,029	0,60	0,27	0,041	0,23	0,18
3,0	5°	4,50	4,90	5,10	5,70	6,40	0,036	0,60	0,45	0,051	0,23	0,30
3,0	4°	9,00	9,50	9,70	10,50	∞	0,036	0,60	0,39	0,051	0,23	0,30
3,0	3°	15,00	15,60	16,10	∞	∞	0,032	0,60	0,33	0,046	0,23	0,24
3,0	2°	21,00	21,80	22,80	∞	∞	0,029	0,60	0,27	0,041	0,23	0,18
3,0	5°	4,50	4,90	5,10	5,60	6,20	0,036	0,60	0,45	0,051	0,23	0,30
3,0	4°	9,00	9,50	9,70	10,40	∞	0,036	0,60	0,39	0,051	0,23	0,30
3,0	3°	15,00	15,60	16,00	∞	∞	0,032	0,60	0,33	0,046	0,23	0,24
3,0	2°	21,00	21,80	22,70	∞	∞	0,029	0,60	0,27	0,041	0,23	0,18

Abmessungen in mm  
Dimensions in mm

### DSTH

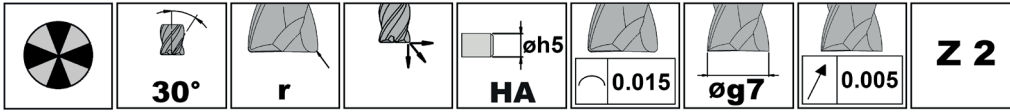

B

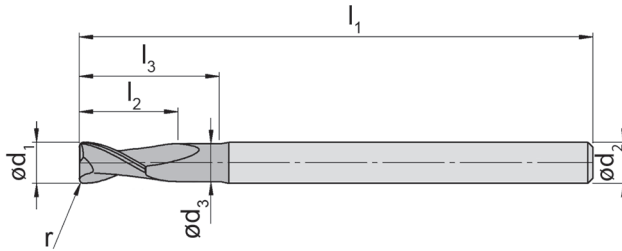

Bestellnummer Part number	d <sub>1</sub>	r	l <sub>2</sub>	l <sub>3</sub>	d <sub>3</sub>	d <sub>2</sub>	l <sub>1</sub>	Z	γ	TS3E
DSTH.2.040.020.015	4	0,2	6	6	-	6	64	2	20°	▲
DSTH.2.040.020.030	4	0,2	6	12	3,8	6	64	2	20°	▲
DSTH.2.040.020.050	4	0,2	6	20	3,8	6	64	2	20°	▲
DSTH.2.040.020.070	4	0,2	6	28	3,8	6	78	2	20°	▲
DSTH.2.040.050.015	4	0,5	6	6	-	6	64	2	20°	▲
DSTH.2.040.050.030	4	0,5	6	12	3,8	6	64	2	20°	▲
DSTH.2.040.050.050	4	0,5	6	20	3,8	6	64	2	20°	▲
DSTH.2.040.050.070	4	0,5	6	28	3,8	6	78	2	20°	▲
DSTH.2.040.100.015	4	1,0	6	6	-	6	64	2	20°	▲
DSTH.2.040.100.030	4	1,0	6	12	3,8	6	64	2	20°	▲
DSTH.2.040.100.050	4	1,0	6	20	3,8	6	64	2	20°	▲
DSTH.2.040.100.070	4	1,0	6	28	3,8	6	78	2	20°	▲

▲ ab Lager / on stock Δ 4 Wochen / 4 weeks x auf Anfrage / upon request

● empfohlen / recommended

o bedingt einsetzbar / alternative recommendation

- nicht geeignet / not suitable

■ unbeschichtete HM-Sorten / uncoated grades

■ beschichtete HM-Sorten / coated grades

■ bestückt/Cermet / brazed/Cermet

Abmessungen in mm

Dimensions in mm

P	-
M	-
K	-
N	-
S	-
H	•



HM-Sorten  
Carbide grades

# Schnittdaten DSTH Ø 4 mm



## Cutting Data DSTH Ø 4 mm

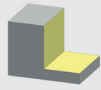



### Konventionelles Fräsen / Conventional milling

		
	vc = m/min	vc = m/min
H1.1	120	150
H1.2	100	130
H1.3	80	100
H1.4	70	90

### HSC Fräsen / HSC milling

		
	vc = m/min	vc = m/min
H1.1	180	220
H1.2	160	190
H1.3	140	170
H1.4	120	140

B

d <sub>1</sub>							
		f <sub>z</sub>	a <sub>e</sub>	a <sub>p</sub>	f <sub>z</sub>	a <sub>e</sub>	a <sub>p</sub>
4	5°	0,047	0,80	0,60	0,067	0,30	0,40
4	4°	0,047	0,80	0,52	0,067	0,30	0,40
4	3°	0,042	0,80	0,44	0,060	0,30	0,32
4	2°	0,037	0,80	0,36	0,054	0,30	0,24
4	5°	0,047	0,80	0,60	0,067	0,30	0,40
4	4°	0,047	0,80	0,52	0,067	0,30	0,40
4	3°	0,042	0,80	0,44	0,060	0,30	0,32
4	2°	0,037	0,80	0,36	0,054	0,30	0,24
4	5°	0,047	0,80	0,60	0,067	0,30	0,40
4	4°	0,047	0,80	0,52	0,067	0,30	0,40
4	3°	0,042	0,80	0,44	0,060	0,30	0,32
4	2°	0,037	0,80	0,36	0,054	0,30	0,24

Abmessungen in mm  
Dimensions in mm

### DSTH

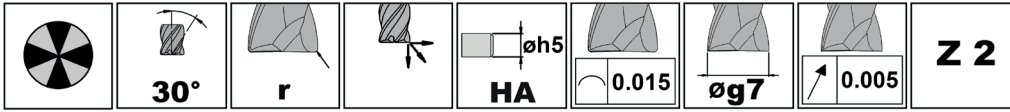

B

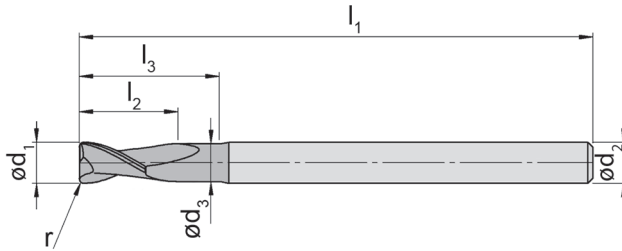

Bestellnummer Part number	d <sub>1</sub>	r	l <sub>2</sub>	l <sub>3</sub>	d <sub>3</sub>	d <sub>2</sub>	l <sub>1</sub>	Z	γ	TS3E
DSTH.2.050.020.015	5	0,2	7,5	7,5	-	6	64	2	20°	▲
DSTH.2.050.020.030	5	0,2	7,5	15,0	4,7	6	64	2	20°	▲
DSTH.2.050.020.050	5	0,2	7,5	25,0	4,7	6	64	2	20°	▲
DSTH.2.050.020.070	5	0,2	7,5	35,0	4,7	6	78	2	20°	▲
DSTH.2.050.050.015	5	0,5	7,5	7,5	-	6	64	2	20°	▲
DSTH.2.050.050.030	5	0,5	7,5	15,0	4,7	6	64	2	20°	▲
DSTH.2.050.050.050	5	0,5	7,5	25,0	4,7	6	64	2	20°	▲
DSTH.2.050.050.070	5	0,5	7,5	35,0	4,7	6	78	2	20°	▲
DSTH.2.050.100.015	5	1,0	7,5	7,5	-	6	64	2	20°	▲
DSTH.2.050.100.030	5	1,0	7,5	15,0	4,7	6	64	2	20°	▲
DSTH.2.050.100.050	5	1,0	7,5	25,0	4,7	6	64	2	20°	▲
DSTH.2.050.100.070	5	1,0	7,5	35,0	4,7	6	78	2	20°	▲

▲ ab Lager / on stock Δ 4 Wochen / 4 weeks x auf Anfrage / upon request

● empfohlen / recommended

o bedingt einsetzbar / alternative recommendation

- nicht geeignet / not suitable

■ unbeschichtete HM-Sorten / uncoated grades

■ beschichtete HM-Sorten / coated grades

■ bestückt/Cermet / brazed/Cermet

Abmessungen in mm

Dimensions in mm

P	-
M	-
K	-
N	-
S	-
H	•



HM-Sorten  
Carbide grades

# Schnittdaten DSTH Ø 5 mm



## Cutting Data DSTH Ø 5 mm



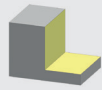

### Konventionelles Fräsen / Conventional milling

		
	<b>vc = m/min</b>	<b>vc = m/min</b>
H1.1	120	150
H1.2	100	130
H1.3	80	100
H1.4	70	90

### HSC Fräsen / HSC milling

		
	<b>vc = m/min</b>	<b>vc = m/min</b>
H1.1	180	220
H1.2	160	190
H1.3	140	170
H1.4	120	140

B

$d_1$							
		$f_z$	$a_e$	$a_p$	$f_z$	$a_e$	$a_p$
5	5°	0,058	1,00	0,75	0,083	0,38	0,50
5	4°	0,058	1,00	0,65	0,083	0,38	0,50
5	3°	0,052	1,00	0,55	0,075	0,38	0,40
5	2°	0,046	1,00	0,45	0,066	0,38	0,30
5	5°	0,058	1,00	0,75	0,083	0,38	0,50
5	4°	0,058	1,00	0,65	0,083	0,38	0,50
5	3°	0,052	1,00	0,55	0,075	0,38	0,40
5	2°	0,046	1,00	0,45	0,066	0,38	0,30
5	5°	0,058	1,00	0,75	0,083	0,38	0,50
5	4°	0,058	1,00	0,65	0,083	0,38	0,50
5	3°	0,052	1,00	0,55	0,075	0,38	0,40
5	2°	0,046	1,00	0,45	0,066	0,38	0,30

Abmessungen in mm  
Dimensions in mm



### DSTH

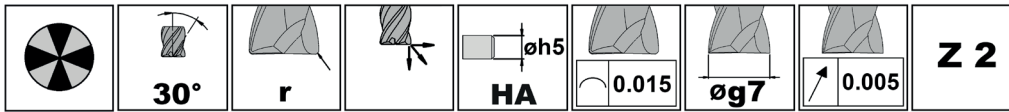

B

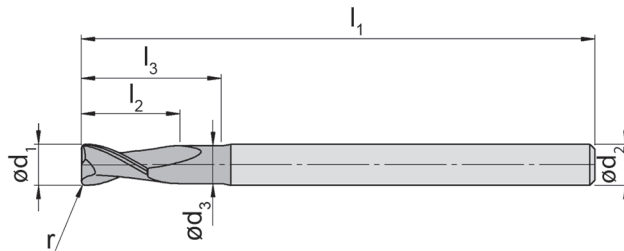

Bestellnummer Part number	d <sub>1</sub>	r	l <sub>2</sub>	l <sub>3</sub>	d <sub>3</sub>	d <sub>2</sub>	l <sub>1</sub>	Z	TS3E
DSTH.2.060.020.015	6	0,2	9	9	-	6	64	2	▲
DSTH.2.060.020.030	6	0,2	9	18	5,7	6	64	2	▲
DSTH.2.060.020.050	6	0,2	9	30	5,7	6	78	2	▲
DSTH.2.060.020.070	6	0,2	9	42	5,7	6	78	2	▲
DSTH.2.060.050.015	6	0,5	9	9	-	6	64	2	▲
DSTH.2.060.050.030	6	0,5	9	18	5,7	6	64	2	▲
DSTH.2.060.050.050	6	0,5	9	30	5,7	6	78	2	▲
DSTH.2.060.050.070	6	0,5	9	42	5,7	6	78	2	▲
DSTH.2.060.100.015	6	1,0	9	9	-	6	64	2	▲
DSTH.2.060.100.030	6	1,0	9	18	5,7	6	64	2	▲
DSTH.2.060.100.050	6	1,0	9	30	5,7	6	78	2	▲
DSTH.2.060.100.070	6	1,0	9	42	5,7	6	78	2	▲
DSTH.2.060.200.015	6	2,0	9	9	-	6	64	2	▲
DSTH.2.060.200.030	6	2,0	9	18	5,7	6	64	2	▲
DSTH.2.060.200.050	6	2,0	9	30	5,7	6	78	2	▲
DSTH.2.060.200.070	6	2,0	9	42	5,7	6	78	2	▲

▲ ab Lager / on stock Δ 4 Wochen / 4 weeks x auf Anfrage / upon request

● empfohlen / recommended

o bedingt einsetzbar / alternative recommendation

- nicht geeignet / not suitable

■ unbeschichtete HM-Sorten / uncoated grades

■ beschichtete HM-Sorten / coated grades

■ bestückt/Cermet / brazed/Cermet

Abmessungen in mm

Dimensions in mm

P	-
M	-
K	-
N	-
S	-
H	•



HM-Sorten  
Carbide grades

# Schnittdaten DSTH Ø 6 mm



## Cutting Data DSTH Ø 6 mm

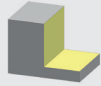

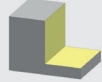

### Konventionelles Fräsen / Conventional milling

		
	vc = m/min	vc = m/min
H1.1	120	150
H1.2	100	130
H1.3	80	100
H1.4	70	90

### HSC Fräsen / HSC milling

		
	vc = m/min	vc = m/min
H1.1	180	220
H1.2	160	190
H1.3	140	170
H1.4	120	140

B

d <sub>1</sub>							
		f <sub>z</sub>	a <sub>e</sub>	a <sub>p</sub>	f <sub>z</sub>	a <sub>e</sub>	a <sub>p</sub>
6	5°	0,069	1,20	0,90	0,099	0,45	0,60
6	4°	0,069	1,20	0,78	0,099	0,45	0,60
6	3°	0,062	1,20	0,66	0,089	0,45	0,48
6	2°	0,055	1,20	0,54	0,079	0,45	0,36
6	5°	0,069	1,20	0,90	0,099	0,45	0,60
6	4°	0,069	1,20	0,78	0,099	0,45	0,60
6	3°	0,062	1,20	0,66	0,089	0,45	0,48
6	2°	0,055	1,20	0,54	0,079	0,45	0,36
6	5°	0,069	1,20	0,90	0,099	0,45	0,60
6	4°	0,069	1,20	0,78	0,099	0,45	0,60
6	3°	0,062	1,20	0,66	0,089	0,45	0,48
6	2°	0,055	1,20	0,54	0,079	0,45	0,36
6	5°	0,069	1,20	0,90	0,099	0,45	0,60
6	4°	0,069	1,20	0,78	0,099	0,45	0,60
6	3°	0,062	1,20	0,66	0,089	0,45	0,48
6	2°	0,055	1,20	0,54	0,079	0,45	0,36

Abmessungen in mm  
Dimensions in mm

### DSTH

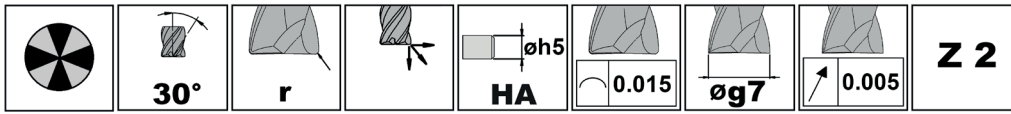

B

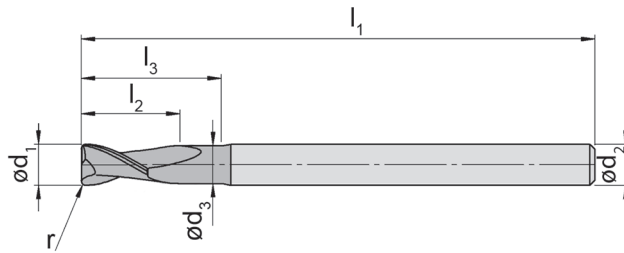

Bestellnummer Part number	d <sub>1</sub>	r	l <sub>2</sub>	l <sub>3</sub>	d <sub>3</sub>	d <sub>2</sub>	l <sub>1</sub>	Z	TS3E
DSTH.2.080.020.015	8	0,2	12	12	-	8	64	2	▲
DSTH.2.080.020.030	8	0,2	12	24	7,6	8	64	2	▲
DSTH.2.080.020.050	8	0,2	12	40	7,6	8	78	2	▲
DSTH.2.080.020.070	8	0,2	12	56	7,6	8	100	2	▲
DSTH.2.080.050.015	8	0,5	12	12	-	8	64	2	▲
DSTH.2.080.050.030	8	0,5	12	24	7,6	8	64	2	▲
DSTH.2.080.050.050	8	0,5	12	40	7,6	8	78	2	▲
DSTH.2.080.050.070	8	0,5	12	56	7,6	8	100	2	▲
DSTH.2.080.100.015	8	1,0	12	12	-	8	64	2	▲
DSTH.2.080.100.030	8	1,0	12	24	7,6	8	64	2	▲
DSTH.2.080.100.050	8	1,0	12	40	7,6	8	78	2	▲
DSTH.2.080.100.070	8	1,0	12	56	7,6	8	100	2	▲
DSTH.2.080.200.015	8	2,0	12	12	-	8	64	2	▲
DSTH.2.080.200.030	8	2,0	12	24	7,6	8	64	2	▲
DSTH.2.080.200.050	8	2,0	12	40	7,6	8	78	2	▲
DSTH.2.080.200.070	8	2,0	12	56	7,6	8	100	2	▲

▲ ab Lager / on stock Δ 4 Wochen / 4 weeks x auf Anfrage / upon request

● empfohlen / recommended

o bedingt einsetzbar / alternative recommendation

- nicht geeignet / not suitable

■ unbeschichtete HM-Sorten / uncoated grades

■ beschichtete HM-Sorten / coated grades

■ bestückt/Cermet / brazed/Cermet

Abmessungen in mm

Dimensions in mm

P	-
M	-
K	-
N	-
S	-
H	•



HM-Sorten  
Carbide grades

# Schnittdaten DSTH Ø 8 mm



## Cutting Data DSTH Ø 8 mm

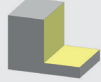

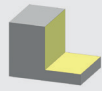

### Konventionelles Fräsen / Conventional milling

		
	vc = m/min	vc = m/min
H1.1	120	150
H1.2	100	130
H1.3	80	100
H1.4	70	90

### HSC Fräsen / HSC milling

		
	vc = m/min	vc = m/min
H1.1	180	220
H1.2	160	190
H1.3	140	170
H1.4	120	140

B

d <sub>1</sub>							
		f <sub>z</sub>	a <sub>e</sub>	a <sub>p</sub>	f <sub>z</sub>	a <sub>e</sub>	a <sub>p</sub>
8	5°	0,092	1,60	1,20	0,130	0,60	0,80
8	4°	0,092	1,60	1,04	0,130	0,60	0,80
8	3°	0,082	1,60	0,88	0,117	0,60	0,64
8	2°	0,073	1,60	0,72	0,104	0,60	0,48
8	5°	0,092	1,60	1,20	0,130	0,60	0,80
8	4°	0,092	1,60	1,04	0,130	0,60	0,80
8	3°	0,082	1,60	0,88	0,117	0,60	0,64
8	2°	0,073	1,60	0,72	0,104	0,60	0,48
8	5°	0,092	1,60	1,20	0,130	0,60	0,80
8	4°	0,092	1,60	1,04	0,130	0,60	0,80
8	3°	0,082	1,60	0,88	0,117	0,60	0,64
8	2°	0,073	1,60	0,72	0,104	0,60	0,48
8	5°	0,092	1,60	1,20	0,130	0,60	0,80
8	4°	0,092	1,60	1,04	0,130	0,60	0,80
8	3°	0,082	1,60	0,88	0,117	0,60	0,64
8	2°	0,073	1,60	0,72	0,104	0,60	0,48

Abmessungen in mm  
Dimensions in mm

### DSTH

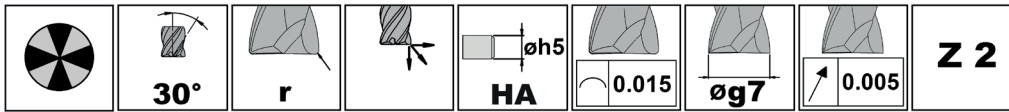

B

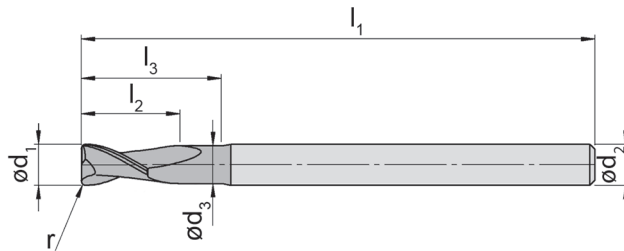

Bestellnummer Part number	d <sub>1</sub>	r	l <sub>2</sub>	l <sub>3</sub>	d <sub>3</sub>	d <sub>2</sub>	l <sub>1</sub>	Z	TS3E
DSTH.2.100.020.015	10	0,2	15	15	-	10	78	2	▲
DSTH.2.100.020.030	10	0,2	15	30	9,6	10	78	2	▲
DSTH.2.100.020.050	10	0,2	15	50	9,6	10	100	2	▲
DSTH.2.100.020.070	10	0,2	15	70	9,6	10	120	2	▲
DSTH.2.100.050.015	10	0,5	15	15	-	10	78	2	▲
DSTH.2.100.050.030	10	0,5	15	30	9,6	10	78	2	▲
DSTH.2.100.050.050	10	0,5	15	50	9,6	10	100	2	▲
DSTH.2.100.050.070	10	0,5	15	70	9,6	10	120	2	▲
DSTH.2.100.100.015	10	1,0	15	15	-	10	78	2	▲
DSTH.2.100.100.030	10	1,0	15	30	9,6	10	78	2	▲
DSTH.2.100.100.050	10	1,0	15	50	9,6	10	100	2	▲
DSTH.2.100.100.070	10	1,0	15	70	9,6	10	120	2	▲
DSTH.2.100.200.015	10	2,0	15	15	-	10	78	2	▲
DSTH.2.100.200.030	10	2,0	15	30	9,6	10	78	2	▲
DSTH.2.100.200.050	10	2,0	15	50	9,6	10	100	2	▲
DSTH.2.100.200.070	10	2,0	15	70	9,6	10	120	2	▲

▲ ab Lager / on stock   Δ 4 Wochen / 4 weeks   x auf Anfrage / upon request

● empfohlen / recommended

o bedingt einsetzbar / alternative recommendation

- nicht geeignet / not suitable

■ unbeschichtete HM-Sorten / uncoated grades

■ beschichtete HM-Sorten / coated grades

■ bestückt/Cermet / brazed/Cermet

Abmessungen in mm

Dimensions in mm

P	-
M	-
K	-
N	-
S	-
H	•



HM-Sorten  
Carbide grades

# Schnittdaten DSTH Ø 10 mm



## Cutting Data DSTH Ø 10 mm





### Konventionelles Fräsen / Conventional milling

		
	vc = m/min	vc = m/min
H1.1	120	150
H1.2	100	130
H1.3	80	100
H1.4	70	90

### HSC Fräsen / HSC milling

		
	vc = m/min	vc = m/min
H1.1	180	220
H1.2	160	190
H1.3	140	170
H1.4	120	140

B

d <sub>1</sub>							
		f <sub>z</sub>	a <sub>e</sub>	a <sub>p</sub>	f <sub>z</sub>	a <sub>e</sub>	a <sub>p</sub>
10	5°	0,114	2,00	1,50	0,162	0,75	1,00
10	4°	0,114	2,00	1,30	0,162	0,75	1,00
10	3°	0,103	2,00	1,10	0,146	0,75	0,80
10	2°	0,091	2,00	0,90	0,130	0,75	0,60
10	5°	0,114	2,00	1,50	0,162	0,75	1,00
10	4°	0,114	2,00	1,30	0,162	0,75	1,00
10	3°	0,103	2,00	1,10	0,146	0,75	0,80
10	2°	0,091	2,00	0,90	0,130	0,75	0,60
10	5°	0,114	2,00	1,50	0,162	0,75	1,00
10	4°	0,114	2,00	1,30	0,162	0,75	1,00
10	3°	0,103	2,00	1,10	0,146	0,75	0,80
10	2°	0,091	2,00	0,90	0,130	0,75	0,60
10	5°	0,114	2,00	1,50	0,162	0,75	1,00
10	4°	0,114	2,00	1,30	0,162	0,75	1,00
10	3°	0,103	2,00	1,10	0,146	0,75	0,80
10	2°	0,091	2,00	0,90	0,130	0,75	0,60

Abmessungen in mm  
Dimensions in mm

### DSTH

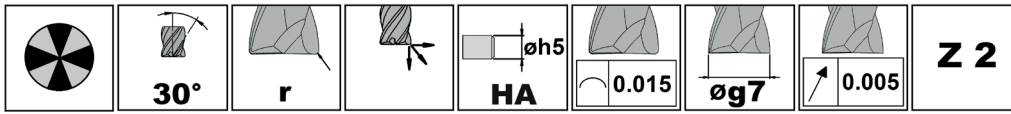

B

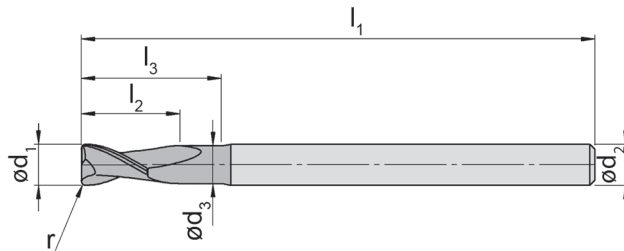

Bestellnummer Part number	d <sub>1</sub>	r	l <sub>2</sub>	l <sub>3</sub>	d <sub>3</sub>	d <sub>2</sub>	l <sub>1</sub>	Z	TS3E
DSTH.2.120.020.015	12	0,2	18	18	-	12	78	2	▲
DSTH.2.120.020.030	12	0,2	18	36	11,6	12	100	2	▲
DSTH.2.120.020.050	12	0,2	18	60	11,6	12	120	2	▲
DSTH.2.120.020.070	12	0,2	18	84	11,6	12	140	2	▲
DSTH.2.120.050.015	12	0,5	18	18	-	12	78	2	▲
DSTH.2.120.050.030	12	0,5	18	36	11,6	12	100	2	▲
DSTH.2.120.050.050	12	0,5	18	60	11,6	12	120	2	▲
DSTH.2.120.050.070	12	0,5	18	84	11,6	12	140	2	▲
DSTH.2.120.100.015	12	1,0	18	18	-	12	78	2	▲
DSTH.2.120.100.030	12	1,0	18	36	11,6	12	100	2	▲
DSTH.2.120.100.050	12	1,0	18	60	11,6	12	120	2	▲
DSTH.2.120.100.070	12	1,0	18	84	11,6	12	140	2	▲
DSTH.2.120.200.015	12	2,0	18	18	-	12	78	2	▲
DSTH.2.120.200.030	12	2,0	18	36	11,6	12	100	2	▲
DSTH.2.120.200.050	12	2,0	18	60	11,6	12	120	2	▲
DSTH.2.120.200.070	12	2,0	18	84	11,6	12	140	2	▲

▲ ab Lager / on stock   Δ 4 Wochen / 4 weeks   x auf Anfrage / upon request

● empfohlen / recommended

o bedingt einsetzbar / alternative recommendation

- nicht geeignet / not suitable

■ unbeschichtete HM-Sorten / uncoated grades

■ beschichtete HM-Sorten / coated grades

■ bestückt/Cermet / brazed/Cermet

Abmessungen in mm

Dimensions in mm

P	-
M	-
K	-
N	-
S	-
H	•



HM-Sorten  
Carbide grades

# Schnittdaten DSTH Ø 12 mm



## Cutting Data DSTH Ø 12 mm

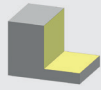

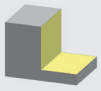

### Konventionelles Fräsen / Conventional milling

		
	vc = m/min	vc = m/min
H1.1	120	150
H1.2	100	130
H1.3	80	100
H1.4	70	90

### HSC Fräsen / HSC milling

		
	vc = m/min	vc = m/min
H1.1	180	220
H1.2	160	190
H1.3	140	170
H1.4	120	140

B

d <sub>1</sub>							
		f <sub>z</sub>	a <sub>e</sub>	a <sub>p</sub>	f <sub>z</sub>	a <sub>e</sub>	a <sub>p</sub>
12	5°	0,136	2,40	1,80	0,194	0,90	1,20
12	4°	0,136	2,40	1,56	0,194	0,90	1,20
12	3°	0,123	2,40	1,32	0,175	0,90	0,96
12	2°	0,109	2,40	1,08	0,155	0,90	0,72
12	5°	0,136	2,40	1,80	0,194	0,90	1,20
12	4°	0,136	2,40	1,56	0,194	0,90	1,20
12	3°	0,123	2,40	1,32	0,175	0,90	0,96
12	2°	0,109	2,40	1,08	0,155	0,90	0,72
12	5°	0,136	2,40	1,80	0,194	0,90	1,20
12	4°	0,136	2,40	1,56	0,194	0,90	1,20
12	3°	0,123	2,40	1,32	0,175	0,90	0,96
12	2°	0,109	2,40	1,08	0,155	0,90	0,72
12	5°	0,136	2,40	1,80	0,194	0,90	1,20
12	4°	0,136	2,40	1,56	0,194	0,90	1,20
12	3°	0,123	2,40	1,32	0,175	0,90	0,96
12	2°	0,109	2,40	1,08	0,155	0,90	0,72

Abmessungen in mm  
Dimensions in mm



### DSTH

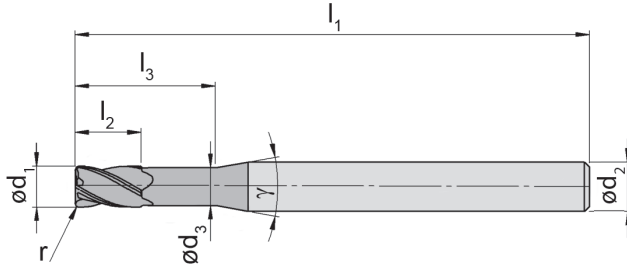
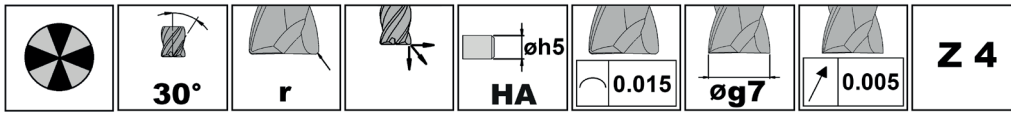

B

Bestellnummer Part number	d <sub>1</sub>	r	l <sub>2</sub>	l <sub>3</sub>	d <sub>3</sub>	d <sub>2</sub>	l <sub>1</sub>	Z	γ	TS3E
DSTH.4.040.020.015	4	0,2	6,0	6,0	-	6	64	4	20°	▲
DSTH.4.040.020.030	4	0,2	6,0	12,0	3,8	6	64	4	20°	▲
DSTH.4.040.020.050	4	0,2	6,0	20,0	3,8	6	64	4	20°	▲
DSTH.4.040.020.070	4	0,2	6,0	28,0	3,8	6	78	4	20°	▲
DSTH.4.040.050.015	4	0,5	6,0	6,0	-	6	64	4	20°	▲
DSTH.4.040.050.030	4	0,5	6,0	12,0	3,8	6	64	4	20°	▲
DSTH.4.040.050.050	4	0,5	6,0	20,0	3,8	6	64	4	20°	▲
DSTH.4.040.050.070	4	0,5	6,0	28,0	3,8	6	78	4	20°	▲
DSTH.4.040.100.015	4	1,0	6,0	6,0	-	6	64	4	20°	▲
DSTH.4.040.100.030	4	1,0	6,0	12,0	3,8	6	64	4	20°	▲
DSTH.4.040.100.050	4	1,0	6,0	20,0	3,8	6	64	4	20°	▲
DSTH.4.040.100.070	4	1,0	6,0	28,0	3,8	6	78	4	20°	▲
DSTH.4.050.020.015	5	0,2	7,5	7,5	-	6	64	4	20°	▲
DSTH.4.050.020.030	5	0,2	7,5	15,0	4,7	6	64	4	20°	▲
DSTH.4.050.020.050	5	0,2	7,5	25,0	4,7	6	64	4	20°	▲
DSTH.4.050.020.070	5	0,2	7,5	35,0	4,7	6	78	4	20°	▲
DSTH.4.050.050.015	5	0,5	7,5	7,5	-	6	64	4	20°	▲
DSTH.4.050.050.030	5	0,5	7,5	15,0	4,7	6	64	4	20°	▲
DSTH.4.050.050.050	5	0,5	7,5	25,0	4,7	6	64	4	20°	▲
DSTH.4.050.050.070	5	0,5	7,5	35,0	4,7	6	78	4	20°	▲
DSTH.4.050.100.015	5	1,0	7,5	7,5	-	6	64	4	20°	▲
DSTH.4.050.100.030	5	1,0	7,5	15,0	4,7	6	64	4	20°	▲
DSTH.4.050.100.050	5	1,0	7,5	25,0	4,7	6	64	4	20°	▲
DSTH.4.050.100.070	5	1,0	7,5	35,0	4,7	6	78	4	20°	▲

▲ ab Lager / on stock Δ 4 Wochen / 4 weeks x auf Anfrage / upon request

● empfohlen / recommended

o bedingt einsetzbar / alternative recommendation

- nicht geeignet / not suitable

■ unbeschichtete HM-Sorten / uncoated grades

■ beschichtete HM-Sorten / coated grades

■ bestückt/Cermet / brazed/Cermet

Abmessungen in mm

Dimensions in mm

P	-
M	-
K	-
N	-
S	-
H	●



HM-Sorten  
Carbide grades

# Schnittdaten DSTH Ø 4 - 5 mm



## Cutting Data DSTH Ø 4 - 5 mm

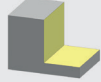

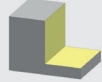

### Konventionelles Fräsen / Conventional milling

		
	vc = m/min	vc = m/min
H1.1	120	150
H1.2	100	130
H1.3	80	100
H1.4	70	90

### HSC Fräsen / HSC milling

		
	vc = m/min	vc = m/min
H1.1	180	220
H1.2	160	190
H1.3	140	170
H1.4	120	140

B

d <sub>1</sub>							
		f <sub>z</sub>	a <sub>e</sub>	a <sub>p</sub>	f <sub>z</sub>	a <sub>e</sub>	a <sub>p</sub>
4	5°	0,019	0,80	0,60	0,022	0,30	0,40
4	4°	0,019	0,80	0,52	0,022	0,30	0,40
4	3°	0,017	0,80	0,44	0,020	0,30	0,32
4	2°	0,015	0,80	0,36	0,018	0,30	0,24
4	5°	0,019	0,80	0,60	0,022	0,30	0,40
4	4°	0,019	0,80	0,52	0,022	0,30	0,40
4	3°	0,017	0,80	0,44	0,020	0,30	0,32
4	2°	0,015	0,80	0,36	0,018	0,30	0,24
4	5°	0,019	0,80	0,60	0,022	0,30	0,40
4	4°	0,019	0,80	0,52	0,022	0,30	0,40
4	3°	0,017	0,80	0,44	0,020	0,30	0,32
4	2°	0,015	0,80	0,36	0,018	0,30	0,24
5	5°	0,030	1,00	0,75	0,038	0,38	0,50
5	4°	0,030	1,00	0,65	0,038	0,38	0,50
5	3°	0,027	1,00	0,55	0,034	0,38	0,40
5	2°	0,024	1,00	0,45	0,030	0,38	0,30
5	5°	0,030	1,00	0,75	0,038	0,38	0,50
5	4°	0,030	1,00	0,65	0,038	0,38	0,50
5	3°	0,027	1,00	0,55	0,034	0,38	0,40
5	2°	0,024	1,00	0,45	0,030	0,38	0,30
5	5°	0,030	1,00	0,75	0,038	0,38	0,50
5	4°	0,030	1,00	0,65	0,038	0,38	0,50
5	3°	0,027	1,00	0,55	0,034	0,38	0,40
5	2°	0,024	1,00	0,45	0,030	0,38	0,30

Abmessungen in mm  
Dimensions in mm

### DSTH

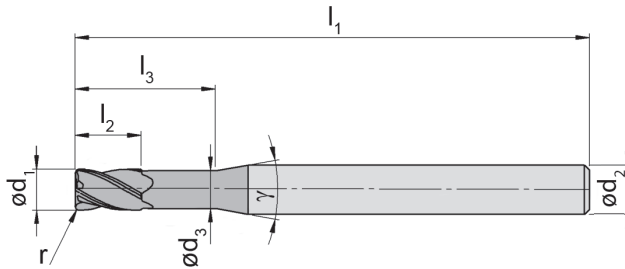
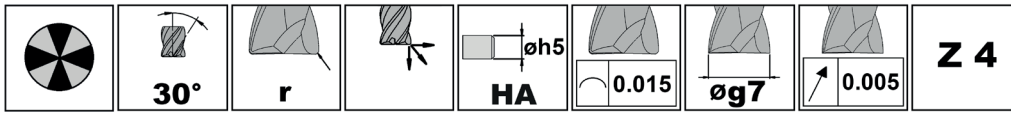

B

Bestellnummer Part number	d <sub>1</sub>	r	l <sub>2</sub>	l <sub>3</sub>	d <sub>3</sub>	d <sub>2</sub>	l <sub>1</sub>	Z	TS3E
DSTH.4.060.020.015	6	0,2	9	9	-	6	64	4	▲
DSTH.4.060.020.030	6	0,2	9	18	5,7	6	64	4	▲
DSTH.4.060.020.050	6	0,2	9	30	5,7	6	78	4	▲
DSTH.4.060.020.070	6	0,2	9	42	5,7	6	78	4	▲
DSTH.4.060.050.015	6	0,5	9	9	-	6	64	4	▲
DSTH.4.060.050.030	6	0,5	9	18	5,7	6	64	4	▲
DSTH.4.060.050.050	6	0,5	9	30	5,7	6	78	4	▲
DSTH.4.060.050.070	6	0,5	9	42	5,7	6	78	4	▲
DSTH.4.060.100.015	6	1,0	9	9	-	6	64	4	▲
DSTH.4.060.100.030	6	1,0	9	18	5,7	6	64	4	▲
DSTH.4.060.100.050	6	1,0	9	30	5,7	6	78	4	▲
DSTH.4.060.100.070	6	1,0	9	42	5,7	6	78	4	▲
DSTH.4.060.200.015	6	2,0	9	9	-	6	64	4	▲
DSTH.4.060.200.030	6	2,0	9	18	5,7	6	64	4	▲
DSTH.4.060.200.050	6	2,0	9	30	5,7	6	78	4	▲
DSTH.4.060.200.070	6	2,0	9	42	5,7	6	78	4	▲

▲ ab Lager / on stock   Δ 4 Wochen / 4 weeks   x auf Anfrage / upon request

● empfohlen / recommended

o bedingt einsetzbar / alternative recommendation

- nicht geeignet / not suitable

■ unbeschichtete HM-Sorten / uncoated grades

■ beschichtete HM-Sorten / coated grades

■ bestückt/Cermet / brazed/Cermet

Abmessungen in mm

Dimensions in mm

P	-
M	-
K	-
N	-
S	-
H	•



HM-Sorten  
Carbide grades

# Schnittdaten DSTH Ø 6 mm



## Cutting Data DSTH Ø 6 mm

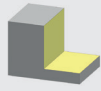

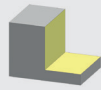

### Konventionelles Fräsen / Conventional milling

		
	vc = m/min	vc = m/min
H1.1	120	150
H1.2	100	130
H1.3	80	100
H1.4	70	90

### HSC Fräsen / HSC milling

		
	vc = m/min	vc = m/min
H1.1	180	220
H1.2	160	190
H1.3	140	170
H1.4	120	140

B

d <sub>1</sub>							
		f <sub>z</sub>	a <sub>e</sub>	a <sub>p</sub>	f <sub>z</sub>	a <sub>e</sub>	a <sub>p</sub>
6	5°	0,040	1,20	0,90	0,053	0,45	0,60
6	4°	0,040	1,20	0,78	0,053	0,45	0,60
6	3°	0,036	1,20	0,66	0,048	0,45	0,48
6	2°	0,032	1,20	0,54	0,042	0,45	0,36
6	5°	0,040	1,20	0,90	0,053	0,45	0,60
6	4°	0,040	1,20	0,78	0,053	0,45	0,60
6	3°	0,036	1,20	0,66	0,048	0,45	0,48
6	2°	0,032	1,20	0,54	0,042	0,45	0,36
6	5°	0,040	1,20	0,90	0,053	0,45	0,60
6	4°	0,040	1,20	0,78	0,053	0,45	0,60
6	3°	0,036	1,20	0,66	0,048	0,45	0,48
6	2°	0,032	1,20	0,54	0,042	0,45	0,36
6	5°	0,040	1,20	0,90	0,053	0,45	0,60
6	4°	0,040	1,20	0,78	0,053	0,45	0,60
6	3°	0,036	1,20	0,66	0,048	0,45	0,48
6	2°	0,032	1,20	0,54	0,042	0,45	0,36

Abmessungen in mm  
Dimensions in mm

### DSTH

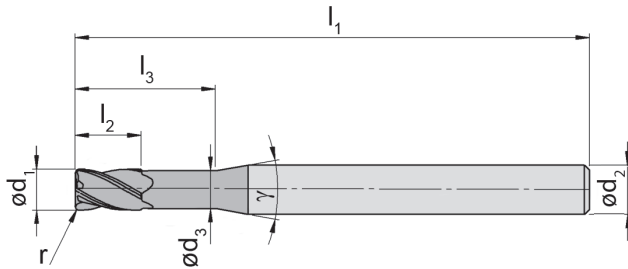
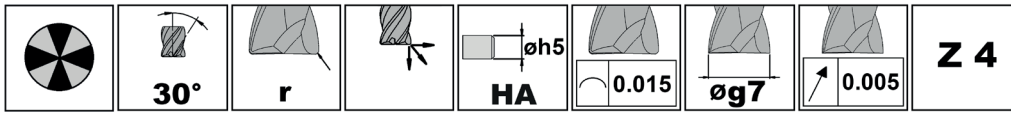

B

Bestellnummer Part number	d <sub>1</sub>	r	l <sub>2</sub>	l <sub>3</sub>	d <sub>3</sub>	d <sub>2</sub>	l <sub>1</sub>	Z	TS3E
DSTH.4.080.020.015	8	0,2	12	12	-	8	64	4	▲
DSTH.4.080.020.030	8	0,2	12	24	7,6	8	64	4	▲
DSTH.4.080.020.050	8	0,2	12	40	7,6	8	78	4	▲
DSTH.4.080.020.070	8	0,2	12	56	7,6	8	100	4	▲
DSTH.4.080.050.015	8	0,5	12	12	-	8	64	4	▲
DSTH.4.080.050.030	8	0,5	12	24	7,6	8	64	4	▲
DSTH.4.080.050.050	8	0,5	12	40	7,6	8	78	4	▲
DSTH.4.080.050.070	8	0,5	12	56	7,6	8	100	4	▲
DSTH.4.080.100.015	8	1,0	12	12	-	8	64	4	▲
DSTH.4.080.100.030	8	1,0	12	24	7,6	8	64	4	▲
DSTH.4.080.100.050	8	1,0	12	40	7,6	8	78	4	▲
DSTH.4.080.100.070	8	1,0	12	56	7,6	8	100	4	▲
DSTH.4.080.200.015	8	2,0	12	12	-	8	64	4	▲
DSTH.4.080.200.030	8	2,0	12	24	7,6	8	64	4	▲
DSTH.4.080.200.050	8	2,0	12	40	7,6	8	78	4	▲
DSTH.4.080.200.070	8	2,0	12	56	7,6	8	100	4	▲

▲ ab Lager / on stock   Δ 4 Wochen / 4 weeks   x auf Anfrage / upon request

● empfohlen / recommended

o bedingt einsetzbar / alternative recommendation

- nicht geeignet / not suitable

■ unbeschichtete HM-Sorten / uncoated grades

■ beschichtete HM-Sorten / coated grades

■ bestückt/Cermet / brazed/Cermet

Abmessungen in mm

Dimensions in mm

P	-
M	-
K	-
N	-
S	-
H	•



HM-Sorten  
Carbide grades

# Schnittdaten DSTH Ø 8 mm



## Cutting Data DSTH Ø 8 mm

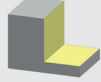



### Konventionelles Fräsen / Conventional milling

		
	vc = m/min	vc = m/min
H1.1	120	150
H1.2	100	130
H1.3	80	100
H1.4	70	90

### HSC Fräsen / HSC milling

		
	vc = m/min	vc = m/min
H1.1	180	220
H1.2	160	190
H1.3	140	170
H1.4	120	140

B

d <sub>1</sub>							
		f <sub>z</sub>	a <sub>e</sub>	a <sub>p</sub>	f <sub>z</sub>	a <sub>e</sub>	a <sub>p</sub>
8	5°	0,060	1,60	1,20	0,083	0,60	0,80
8	4°	0,060	1,60	1,04	0,083	0,60	0,80
8	3°	0,054	1,60	0,88	0,075	0,60	0,64
8	2°	0,048	1,60	0,72	0,067	0,60	0,48
8	5°	0,060	1,60	1,20	0,083	0,60	0,80
8	4°	0,060	1,60	1,04	0,083	0,60	0,80
8	3°	0,054	1,60	0,88	0,075	0,60	0,64
8	2°	0,048	1,60	0,72	0,067	0,60	0,48
8	5°	0,060	1,60	1,20	0,083	0,60	0,80
8	4°	0,060	1,60	1,04	0,083	0,60	0,80
8	3°	0,054	1,60	0,88	0,075	0,60	0,64
8	2°	0,048	1,60	0,72	0,067	0,60	0,48
8	5°	0,060	1,60	1,20	0,083	0,60	0,80
8	4°	0,060	1,60	1,04	0,083	0,60	0,80
8	3°	0,054	1,60	0,88	0,075	0,60	0,64
8	2°	0,048	1,60	0,72	0,067	0,60	0,48

Abmessungen in mm  
Dimensions in mm

### DSTH

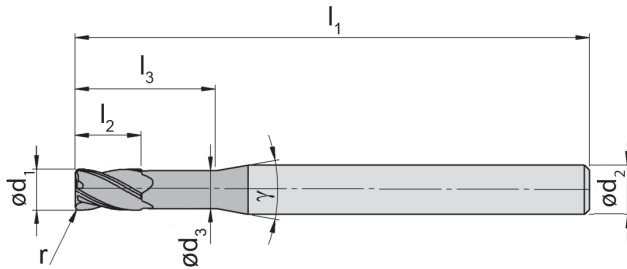
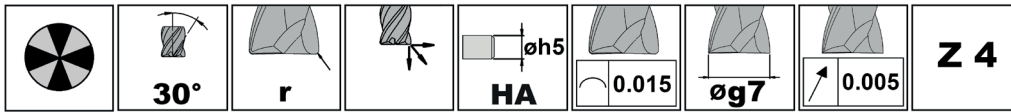

B

Bestellnummer Part number	d <sub>1</sub>	r	l <sub>2</sub>	l <sub>3</sub>	d <sub>3</sub>	d <sub>2</sub>	l <sub>1</sub>	Z	TS3E
DSTH.4.100.020.015	10	0,2	15	15	-	10	78	4	▲
DSTH.4.100.020.030	10	0,2	15	30	9,6	10	78	4	▲
DSTH.4.100.020.050	10	0,2	15	50	9,6	10	100	4	▲
DSTH.4.100.020.070	10	0,2	15	70	9,6	10	120	4	▲
DSTH.4.100.050.015	10	0,5	15	15	-	10	78	4	▲
DSTH.4.100.050.030	10	0,5	15	30	9,6	10	78	4	▲
DSTH.4.100.050.050	10	0,5	15	50	9,6	10	100	4	▲
DSTH.4.100.050.070	10	0,5	15	70	9,6	10	120	4	▲
DSTH.4.100.100.015	10	1,0	15	15	-	10	78	4	▲
DSTH.4.100.100.030	10	1,0	15	30	9,6	10	78	4	▲
DSTH.4.100.100.050	10	1,0	15	50	9,6	10	100	4	▲
DSTH.4.100.100.070	10	1,0	15	70	9,6	10	120	4	▲
DSTH.4.100.200.015	10	2,0	15	15	-	10	78	4	▲
DSTH.4.100.200.030	10	2,0	15	30	9,6	10	78	4	▲
DSTH.4.100.200.050	10	2,0	15	50	9,6	10	100	4	▲
DSTH.4.100.200.070	10	2,0	15	70	9,6	10	120	4	▲

▲ ab Lager / on stock   Δ 4 Wochen / 4 weeks   x auf Anfrage / upon request

● empfohlen / recommended

o bedingt einsetzbar / alternative recommendation

- nicht geeignet / not suitable

■ unbeschichtete HM-Sorten / uncoated grades

■ beschichtete HM-Sorten / coated grades

■ bestückt/Cermet / brazed/Cermet

Abmessungen in mm

Dimensions in mm

P	-
M	-
K	-
N	-
S	-
H	•



HM-Sorten  
Carbide grades

# Schnittdaten DSTH Ø 10 mm



## Cutting Data DSTH Ø 10 mm

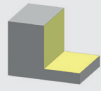

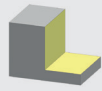

### Konventionelles Fräsen / Conventional milling

		
	vc = m/min	vc = m/min
H1.1	120	150
H1.2	100	130
H1.3	80	100
H1.4	70	90

### HSC Fräsen / HSC milling

		
	vc = m/min	vc = m/min
H1.1	180	220
H1.2	160	190
H1.3	140	170
H1.4	120	140

B

d <sub>1</sub>							
		f <sub>z</sub>	a <sub>e</sub>	a <sub>p</sub>	f <sub>z</sub>	a <sub>e</sub>	a <sub>p</sub>
10	5°	0,080	2,00	1,50	0,114	0,75	1,00
10	4°	0,080	2,00	1,30	0,114	0,75	1,00
10	3°	0,072	2,00	1,10	0,102	0,75	0,80
10	2°	0,064	2,00	0,90	0,091	0,75	0,60
10	5°	0,080	2,00	1,50	0,114	0,75	1,00
10	4°	0,080	2,00	1,30	0,114	0,75	1,00
10	3°	0,072	2,00	1,10	0,102	0,75	0,80
10	2°	0,064	2,00	0,90	0,091	0,75	0,60
10	5°	0,080	2,00	1,50	0,114	0,75	1,00
10	4°	0,080	2,00	1,30	0,114	0,75	1,00
10	3°	0,072	2,00	1,10	0,102	0,75	0,80
10	2°	0,064	2,00	0,90	0,091	0,75	0,60
10	5°	0,080	2,00	1,50	0,114	0,75	1,00
10	4°	0,080	2,00	1,30	0,114	0,75	1,00
10	3°	0,072	2,00	1,10	0,102	0,75	0,80
10	2°	0,064	2,00	0,90	0,091	0,75	0,60

Abmessungen in mm  
Dimensions in mm



### DSTH

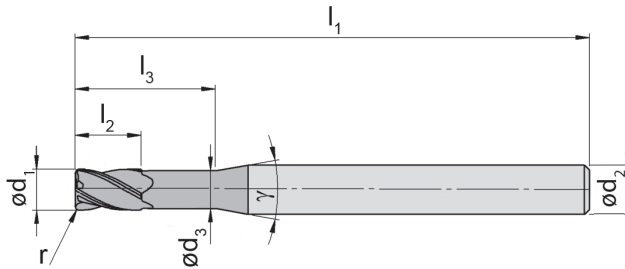
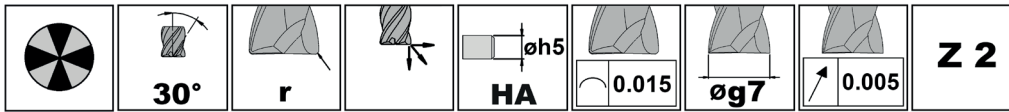

B

Bestellnummer Part number	d <sub>1</sub>	r	l <sub>2</sub>	l <sub>3</sub>	d <sub>3</sub>	d <sub>2</sub>	l <sub>1</sub>	Z	TS3E
DSTH.4.120.020.015	12	0,2	18	18	-	12	78	4	▲
DSTH.4.120.020.030	12	0,2	18	36	11,6	12	100	4	▲
DSTH.4.120.020.050	12	0,2	18	60	11,6	12	120	4	▲
DSTH.4.120.020.070	12	0,2	18	84	11,6	12	140	4	▲
DSTH.4.120.050.015	12	0,5	18	18	-	12	78	4	▲
DSTH.4.120.050.030	12	0,5	18	36	11,6	12	100	4	▲
DSTH.4.120.050.050	12	0,5	18	60	11,6	12	120	4	▲
DSTH.4.120.050.070	12	0,5	18	84	11,6	12	140	4	▲
DSTH.4.120.100.015	12	1,0	18	18	-	12	78	4	▲
DSTH.4.120.100.030	12	1,0	18	36	11,6	12	100	4	▲
DSTH.4.120.100.050	12	1,0	18	60	11,6	12	120	4	▲
DSTH.4.120.100.070	12	1,0	18	84	11,6	12	140	4	▲
DSTH.4.120.200.015	12	2,0	18	18	-	12	78	4	▲
DSTH.4.120.200.030	12	2,0	18	36	11,6	12	100	4	▲
DSTH.4.120.200.050	12	2,0	18	60	11,6	12	120	4	▲
DSTH.4.120.200.070	12	2,0	18	84	11,6	12	140	4	▲

▲ ab Lager / on stock   Δ 4 Wochen / 4 weeks   x auf Anfrage / upon request

● empfohlen / recommended

o bedingt einsetzbar / alternative recommendation

- nicht geeignet / not suitable

■ unbeschichtete HM-Sorten / uncoated grades

■ beschichtete HM-Sorten / coated grades

■ bestückt/Cermet / brazed/Cermet

Abmessungen in mm

Dimensions in mm

P	-
M	-
K	-
N	-
S	-
H	•



HM-Sorten  
Carbide grades

# Schnittdaten DSTH Ø 12 mm



## Cutting Data DSTH Ø 12 mm



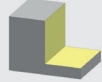

### Konventionelles Fräsen / Conventional milling

		
	vc = m/min	vc = m/min
H1.1	120	150
H1.2	100	130
H1.3	80	100
H1.4	70	90

### HSC Fräsen / HSC milling

		
	vc = m/min	vc = m/min
H1.1	180	220
H1.2	160	190
H1.3	140	170
H1.4	120	140

B

d <sub>1</sub>							
		f <sub>z</sub>	a <sub>e</sub>	a <sub>p</sub>	f <sub>z</sub>	a <sub>e</sub>	a <sub>p</sub>
12	5°	0,101	2,40	1,80	0,144	0,90	1,20
12	4°	0,101	2,40	1,56	0,144	0,90	1,20
12	3°	0,091	2,40	1,32	0,130	0,90	0,96
12	2°	0,081	2,40	1,08	0,115	0,90	0,72
12	5°	0,101	2,40	1,80	0,144	0,90	1,20
12	4°	0,101	2,40	1,56	0,144	0,90	1,20
12	3°	0,091	2,40	1,32	0,130	0,90	0,96
12	2°	0,081	2,40	1,08	0,115	0,90	0,72
12	5°	0,101	2,40	1,80	0,144	0,90	1,20
12	4°	0,101	2,40	1,56	0,144	0,90	1,20
12	3°	0,091	2,40	1,32	0,130	0,90	0,96
12	2°	0,081	2,40	1,08	0,115	0,90	0,72
12	5°	0,101	2,40	1,80	0,144	0,90	1,20
12	4°	0,101	2,40	1,56	0,144	0,90	1,20
12	3°	0,091	2,40	1,32	0,130	0,90	0,96
12	2°	0,081	2,40	1,08	0,115	0,90	0,72

Abmessungen in mm  
Dimensions in mm

# Schaftfräser Mehrschneider

## End Mill multiple fluted



### DSMH

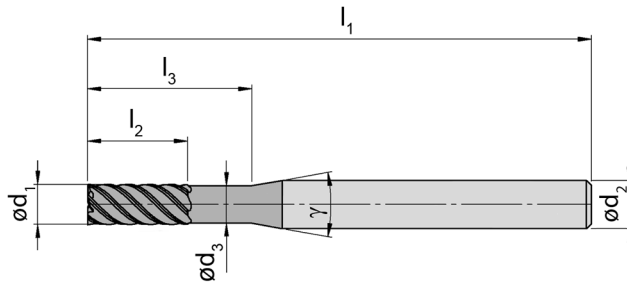
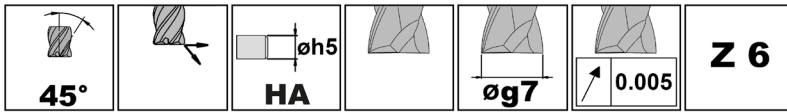

Bis Ø 3 mm vormontiert lieferbar für Toodle Schnelllaufspindel (siehe Seite D2)  
Pre-assembled available up to Ø 3 mm for Toodle high-speed spindle (see page D2)

Bestellnummer Part number	d <sub>1</sub>	l <sub>2</sub>	l <sub>3</sub>	d <sub>3</sub>	d <sub>2</sub>	l <sub>1</sub>	Z	γ	TS3E
DSMH.6.03.040	3	7,5	12	2,86	6	64	6	20°	▲
DSMH.6.04.040	4	10,0	16	3,80	6	64	6	20°	▲
DSMH.6.05.040	5	12,5	20	4,70	6	64	6	20°	▲
DSMH.6.06.040	6	15,0	24	5,70	6	64	6	-°	▲
DSMH.6.08.040	8	20,0	32	7,60	8	78	6	-°	▲
DSMH.6.10.040	10	25,0	40	9,40	10	78	6	-°	▲
DSMH.6.12.040	12	30,0	48	11,40	12	100	6	-°	▲
DSMH.6.16.040	16	40,0	64	15,40	16	120	6	-°	▲

▲ ab Lager / on stock Δ 4 Wochen / 4 weeks x auf Anfrage / upon request

● empfohlen / recommended

o bedingt einsetzbar / alternative recommendation

- nicht geeignet / not suitable

□ unbeschichtete HM-Sorten / uncoated grades

■ beschichtete HM-Sorten / coated grades

■ bestückt/Cermet / brazed/Cermet

Abmessungen in mm

Dimensions in mm

P	-
M	-
K	-
N	-
S	-
H	•





HM-Sorten  
Carbide grades

# Schnittdaten DSMH Ø 3 - 16 mm

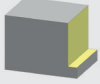
## Cutting Data DSMH Ø 3 - 16 mm



	 vc = m/min	 vc = m/min
H1.1	120	150
H1.2	100	130
H1.3	80	100
H1.4	70	90

 $d_1$	 $\alpha$						
		$f_z$	$a_e$	$a_p$	$f_z$	$a_e$	$a_p$
3	2°	0,009	0,30	6,00	0,009	0,06	6,00
4	2°	0,016	0,40	8,00	0,019	0,08	8,00
5	2°	0,022	0,50	10,00	0,029	0,10	10,00
6	2°	0,028	0,60	12,00	0,039	0,12	12,00
8	2°	0,041	0,80	16,00	0,059	0,16	16,00
10	2°	0,054	1,00	20,00	0,080	0,20	20,00
12	2°	0,066	1,20	24,00	0,100	0,24	24,00
16	2°	0,092	1,60	32,00	0,140	0,32	32,00

Abmessungen in mm  
Dimensions in mm

B

# Schaftfräser Mehrschneider, Eckenradius

## End Mill multiple fluted, corner radius



### DSMRH

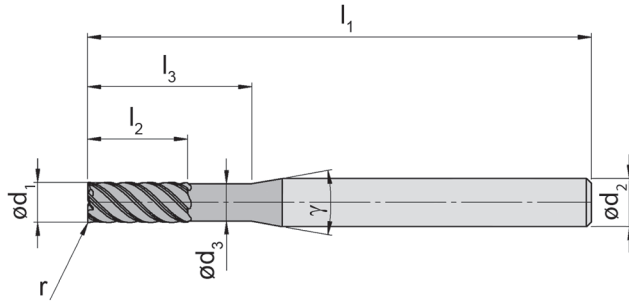
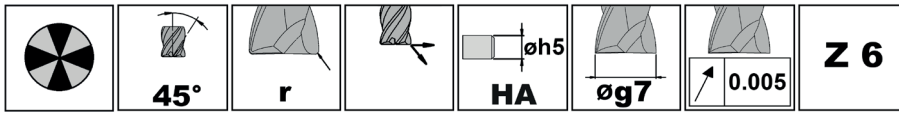

Bis Ø 3 mm vormontiert lieferbar für Toodle Schnelllaufspindel (siehe Seite D2)  
Pre-assembled available up to Ø 3 mm for Toodle high-speed spindle (see page D2)

Bestellnummer Part number	d <sub>1</sub>	r	l <sub>2</sub>	l <sub>3</sub>	d <sub>3</sub>	d <sub>2</sub>	l <sub>1</sub>	Z	γ	TS3E
DSMRH.6.03.020.040	3	0,2	7,5	12	2,86	6	64	6	20°	▲
DSMRH.6.03.050.040	3	0,5	7,5	12	2,86	6	64	6	20°	▲
DSMRH.6.03.100.040	3	1,0	7,5	12	2,86	6	64	6	20°	▲
DSMRH.6.04.020.040	4	0,2	10,0	16	3,80	6	64	6	20°	▲
DSMRH.6.04.050.040	4	0,5	10,0	16	3,80	6	64	6	20°	▲
DSMRH.6.04.100.040	4	1,0	10,0	16	3,80	6	64	6	20°	▲
DSMRH.6.05.020.040	5	0,2	12,5	20	4,70	6	64	6	20°	▲
DSMRH.6.05.050.040	5	0,5	12,5	20	4,70	6	64	6	20°	▲
DSMRH.6.05.100.040	5	1,0	12,5	20	4,70	6	64	6	20°	▲
DSMRH.6.06.020.040	6	0,2	15,0	24	5,70	6	64	6	-°	▲
DSMRH.6.06.050.040	6	0,5	15,0	24	5,70	6	64	6	-°	▲
DSMRH.6.06.100.040	6	1,0	15,0	24	5,70	6	64	6	-°	▲
DSMRH.6.08.020.040	8	0,2	20,0	32	7,60	8	78	6	-°	▲
DSMRH.6.08.050.040	8	0,5	20,0	32	7,60	8	78	6	-°	▲
DSMRH.6.08.100.040	8	1,0	20,0	32	7,60	8	78	6	-°	▲
DSMRH.6.10.020.040	10	0,2	25,0	40	9,40	10	78	6	-°	▲
DSMRH.6.10.050.040	10	0,5	25,0	40	9,40	10	78	6	-°	▲
DSMRH.6.10.100.040	10	1,0	25,0	40	9,40	10	78	6	-°	▲
DSMRH.6.10.200.040	10	2,0	25,0	40	9,40	10	78	6	-°	▲
DSMRH.6.12.020.040	12	0,2	30,0	48	11,40	12	100	6	-°	▲
DSMRH.6.12.050.040	12	0,5	30,0	48	11,40	12	100	6	-°	▲
DSMRH.6.12.100.040	12	1,0	30,0	48	11,40	12	100	6	-°	▲
DSMRH.6.12.200.040	12	2,0	30,0	48	11,40	12	100	6	-°	▲

▲ ab Lager / on stock Δ 4 Wochen / 4 weeks x auf Anfrage / upon request

● empfohlen / recommended

o bedingt einsetzbar / alternative recommendation

- nicht geeignet / not suitable

■ unbeschichtete HM-Sorten / uncoated grades

■ beschichtete HM-Sorten / coated grades

■ bestückt/Cermet / brazed/Cermet

Abmessungen in mm

Dimensions in mm

P	-
M	-
K	-
N	-
S	-
H	•



HM-Sorten  
Carbide grades

# Schnittdaten DSMRH Ø 3 - 12 mm

## Cutting Data DSMH Ø 3 - 12 mm

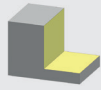
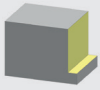

		
	vc = m/min	vc = m/min
H1.1	120	150
H1.2	100	130
H1.3	80	100
H1.4	70	90

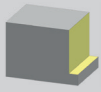
d <sub>1</sub>							
		f <sub>z</sub>	a <sub>e</sub>	a <sub>p</sub>	f <sub>z</sub>	a <sub>e</sub>	a <sub>p</sub>
3	2°	0,009	0,30	6,00	0,009	0,06	6,00
3	2°	0,009	0,30	6,00	0,009	0,06	6,00
3	2°	0,009	0,30	6,00	0,009	0,06	6,00
4	2°	0,016	0,40	8,00	0,019	0,08	8,00
4	2°	0,016	0,40	8,00	0,019	0,08	8,00
4	2°	0,016	0,40	8,00	0,019	0,08	8,00
5	2°	0,022	0,50	10,00	0,029	0,10	10,00
5	2°	0,022	0,50	10,00	0,029	0,10	10,00
5	2°	0,022	0,50	10,00	0,029	0,10	10,00
6	2°	0,028	0,60	12,00	0,039	0,12	12,00
6	2°	0,028	0,60	12,00	0,039	0,12	12,00
6	2°	0,028	0,60	12,00	0,039	0,12	12,00
8	2°	0,041	0,80	16,00	0,059	0,16	16,00
8	2°	0,041	0,80	16,00	0,059	0,16	16,00
8	2°	0,041	0,80	16,00	0,059	0,16	16,00
10	2°	0,054	1,00	20,00	0,080	0,20	20,00
10	2°	0,054	1,00	20,00	0,080	0,20	20,00
10	2°	0,054	1,00	20,00	0,080	0,20	20,00
10	2°	0,054	1,00	20,00	0,080	0,20	20,00
12	2°	0,066	1,20	24,00	0,100	0,24	24,00
12	2°	0,066	1,20	24,00	0,100	0,24	24,00
12	2°	0,066	1,20	24,00	0,100	0,24	24,00
12	2°	0,066	1,20	24,00	0,100	0,24	24,00

Abmessungen in mm  
Dimensions in mm

B

# Vollhartmetall-Schaftfräser

## Solid Carbide End Mills



DSKC

Schaftfräser Vollradius  
Ball Nose End Mill

Ø 1 – Ø 16

Z2-Z7

B118 – B119



DSKC.220°

Schaftfräser 220° Vollradius  
Ball Nose End Mill 220°

Ø 3 – Ø 12

Z2-Z7

B120 – B121



DSTC

Torusfräser  
Torus End Mill

Ø 1,5 – Ø 12

Z2-Z5

B122 – B123



DSMRC

Schaftfräser Mehrschneider,  
Eckenradius  
End Mill multiple fluted, corner radius

Ø 3 – Ø 16

Z2-Z5

B124 – B125

B

**DS**



**B**

**abgestimmt für:**

**- Kobalt-Chrom-Stähle**

**designed for:**

**- Cobalt Chromium Steels**



# Schaftfräser Vollradius

## Ball Nose End Mill



### DSKC

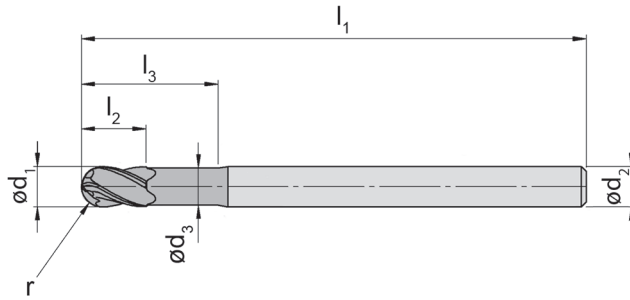
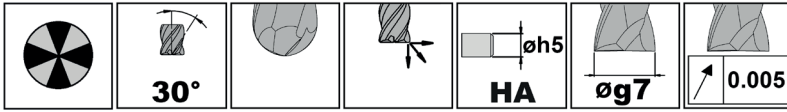

Bis Ø 3 mm vormontiert lieferbar für Toodle Schnelllaufspindel (siehe Seite D2)  
Pre-assembled available up to Ø 3 mm for Toodle high-speed spindle (see page D2)

Bestellnummer Part number	d <sub>1</sub>	r	l <sub>2</sub>	l <sub>3</sub>	d <sub>3</sub>	d <sub>2</sub>	l <sub>1</sub>	Z	TSCC
DSKC.2.010.063.06	1,0	0,50	2	3,0	0,9	6	63	2	▲
DSKC.2.015.063.06	1,5	0,75	2	4,5	1,4	6	63	2	▲
DSKC.2.020.063.06	2,0	1,00	3	5,0	1,9	6	63	2	▲
DSKC.2.020.077.06	2,0	1,00	3	8,0	1,9	6	77	2	▲
DSKC.2.030.063.06	3,0	1,50	4	7,5	2,9	6	63	2	▲
DSKC.2.030.077.06	3,0	1,50	4	12,0	2,9	6	77	2	▲
DSKC.3.040.063.06	4,0	2,00	5	10,0	3,8	6	63	3	▲
DSKC.3.040.077.06	4,0	2,00	5	16,0	3,8	6	77	3	▲
DSKC.4.050.063.06	5,0	2,50	5	12,5	4,7	6	63	4	▲
DSKC.4.050.077.06	5,0	2,50	5	20,0	4,7	6	77	4	▲
DSKC.4.060.063.06	6,0	3,00	6	15,0	5,6	6	63	4	▲
DSKC.4.060.077.06	6,0	3,00	6	24,0	5,6	6	77	4	▲
DSKC.4.060.099.08	6,0	3,00	6	36,0	5,6	8	99	4	▲
DSKC.5.080.063.08	8,0	4,00	8	20,0	7,4	8	63	5	▲
DSKC.5.080.077.08	8,0	4,00	8	32,0	7,4	8	77	5	▲
DSKC.5.080.099.08	8,0	4,00	8	48,0	7,4	8	99	5	▲
DSKC.5.100.077.10	10,0	5,00	10	25,0	9,4	10	77	5	▲
DSKC.5.100.099.10	10,0	5,00	10	40,0	9,4	10	99	5	▲
DSKC.7.120.077.12	12,0	6,00	12	30,0	11,4	12	77	7	▲
DSKC.7.120.099.12	12,0	6,00	12	48,0	11,4	12	99	7	▲
DSKC.7.160.099.16	16,0	8,00	20	50,0	15,4	16	99	7	▲

▲ ab Lager / on stock Δ 4 Wochen / 4 weeks x auf Anfrage / upon request

● empfohlen / recommended

o bedingt einsetzbar / alternative recommendation

- nicht geeignet / not suitable

■ unbeschichtete HM-Sorten / uncoated grades

■ beschichtete HM-Sorten / coated grades

■ bestückt/Cermet / brazed/Cermet

Abmessungen in mm

Dimensions in mm



P	-
M	-
K	-
N	-
S	•
H	o



HM-Sorten  
Carbide grades

# Schnittdaten DSKC Ø 1 - 16 mm

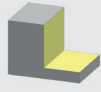
## Cutting Data DSKC Ø 1 - 16 mm

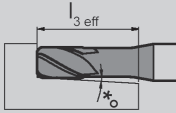

	 $vc = m/min$	 $vc = m/min$
S1	-	-
S2	45	60
S3	40	50

$d_1$	 $\alpha$	 $l_{3\text{eff}}$ $l_{*o}$						
			$f_z$	$a_e$	$a_p$	$f_z$	$a_e$	$a_p$
1,0	5°	0,3	0,011	0,20	0,50	0,017	0,05	0,10
1,5	5°	0,3	0,013	0,30	0,75	0,022	0,08	0,15
2,0	5°	0,3	0,015	0,40	1,00	0,026	0,10	0,20
2,0	5°	0,3	0,015	0,40	1,00	0,026	0,10	0,20
3,0	5°	0,3	0,020	0,60	1,50	0,035	0,15	0,30
3,0	5°	0,3	0,020	0,60	1,50	0,035	0,15	0,30
4,0	5°	0,3	0,018	0,80	2,00	0,032	0,20	0,40
4,0	5°	0,3	0,018	0,80	2,00	0,032	0,20	0,40
5,0	4°	0,3	0,020	1,00	2,50	0,035	0,25	0,50
5,0	4°	0,3	0,020	1,00	2,50	0,035	0,25	0,50
6,0	4°	0,3	0,024	1,20	3,00	0,044	0,30	0,60
6,0	4°	0,3	0,024	1,20	3,00	0,044	0,30	0,60
6,0	4°	0,3	0,024	1,20	3,00	0,044	0,30	0,60
8,0	3°	0,3	0,032	1,60	4,00	0,059	0,40	0,80
8,0	3°	0,3	0,032	1,60	4,00	0,059	0,40	0,80
8,0	3°	0,3	0,032	1,60	4,00	0,059	0,40	0,80
10,0	3°	0,3	0,041	2,00	5,00	0,077	0,50	1,00
10,0	3°	0,3	0,041	2,00	5,00	0,077	0,50	1,00
12,0	3°	0,3	0,048	2,40	6,00	0,091	0,60	1,20
12,0	3°	0,3	0,048	2,40	6,00	0,091	0,60	1,20
16,0	3°	0,3	0,065	3,20	8,00	0,126	0,80	1,60

Abmessungen in mm  
Dimensions in mm

B

# Schaftfräser 220° Vollradius

## Ball Nose End Mill 220°



### DSKC 220°

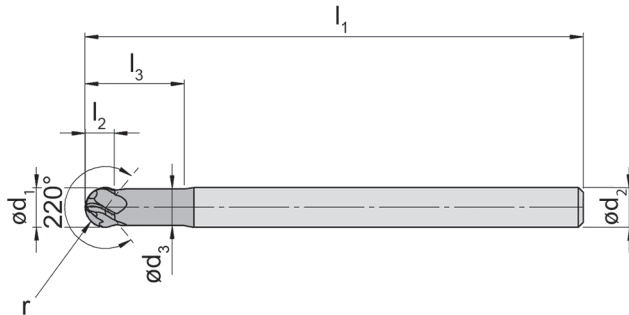
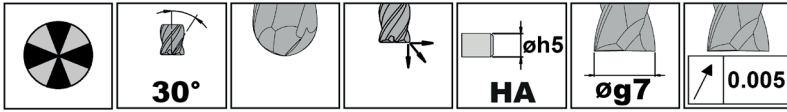

Bis Ø 3 mm vormontiert lieferbar für Toodle Schnelllaufspindel (siehe Seite D2)  
Pre-assembled available up to Ø 3 mm for Toodle high-speed spindle (see page D2)

Bestellnummer Part number	d <sub>1</sub>	r	l <sub>2</sub>	l <sub>3</sub>	d <sub>3</sub>	d <sub>2</sub>	l <sub>1</sub>	Z	TSCC
<b>DSKC.2.030.063.06.2</b>	3	1,5	2,0	15	2,80	6	63	2	▲
<b>DSKC.3.040.063.06.2</b>	4	2,0	2,6	20	3,75	6	63	3	▲
<b>DSKC.4.050.063.06.2</b>	5	2,5	3,3	25	4,70	6	63	4	▲
<b>DSKC.4.060.063.06.2</b>	6	3,0	4,0	30	5,65	6	63	4	▲
<b>DSKC.5.080.088.08.2</b>	8	4,0	5,3	40	7,50	8	88	5	▲
<b>DSKC.5.100.101.10.2</b>	10	5,0	6,7	50	9,40	10	101	5	▲
<b>DSKC.7.120.119.12.2</b>	12	6,0	8,0	60	11,30	12	119	7	▲

▲ ab Lager / on stock Δ 4 Wochen / 4 weeks x auf Anfrage / upon request

● empfohlen / recommended

o bedingt einsetzbar / alternative recommendation

- nicht geeignet / not suitable

■ unbeschichtete HM-Sorten / uncoated grades

■ beschichtete HM-Sorten / coated grades

■ bestückt/Cermet / brazed/Cermet

Abmessungen in mm

Dimensions in mm



P	-
M	-
K	-
N	-
S	•
H	o



HM-Sorten  
Carbide grades

# Schnittdaten DSKC Ø 3 - 12 mm

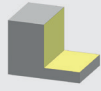
## Cutting Data DSKC Ø 3 - 12 mm

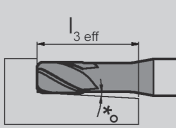

	 $vc = m/min$	 $vc = m/min$
S1	-	-
S2	45	60
S3	40	50

$d_1$	 $\alpha$	 $l_{3\text{eff}}$ $l_{*o}$ $0^\circ$						
			$f_z$	$a_e$	$a_p$	$f_z$	$a_e$	$a_p$
3	5°	0,3	0,015	0,60	1,50	0,026	0,15	0,30
4	5°	0,3	0,014	0,80	2,00	0,023	0,20	0,40
5	4°	0,3	0,015	1,00	2,50	0,027	0,25	0,50
6	4°	0,3	0,020	1,20	3,00	0,035	0,30	0,60
8	3°	0,3	0,027	1,60	4,00	0,050	0,40	0,80
10	3°	0,3	0,036	2,00	5,00	0,068	0,50	1,00
12	3°	0,3	0,043	2,40	6,00	0,082	0,60	1,20

Abmessungen in mm  
Dimensions in mm

B

### DSTC

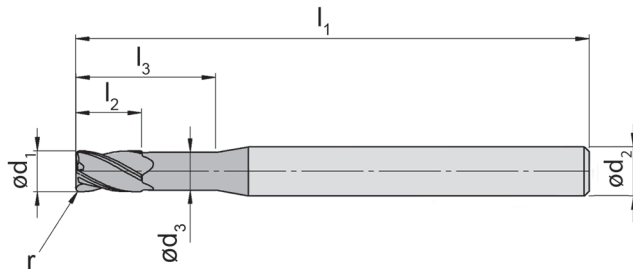
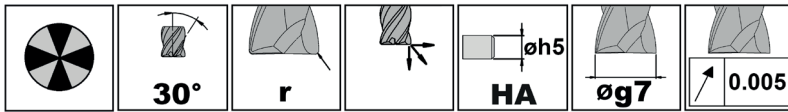

Bis Ø 3 mm vormontiert lieferbar für Toodle Schnelllaufspindel (siehe Seite D2)  
Pre-assembled available up to Ø 3 mm for Toodle high-speed spindle (see page D2)

Bestellnummer Part number	d <sub>1</sub>	r	l <sub>2</sub>	l <sub>3</sub>	d <sub>3</sub>	d <sub>2</sub>	l <sub>1</sub>	Z	TSCC
DSTC.2.15.01.055.06	1,5	0,1	2,5	5,5	1,4	6	55	2	▲
DSTC.2.02.02.055.06	2,0	0,2	3,0	5,5	1,9	6	55	2	▲
DSTC.2.03.02.055.06	3,0	0,2	4,0	7,5	2,9	6	55	2	▲
DSTC.2.03.05.055.06	3,0	0,5	4,0	7,5	2,9	6	55	2	▲
DSTC.3.04.02.055.06	4,0	0,2	5,0	8,5	3,8	6	55	3	▲
DSTC.3.04.05.055.06	4,0	0,5	5,0	8,5	3,8	6	55	3	▲
DSTC.4.05.02.055.06	5,0	0,2	6,0	12,5	4,7	6	55	4	▲
DSTC.4.05.05.055.06	5,0	0,5	6,0	12,5	4,7	6	55	4	▲
DSTC.4.05.10.055.06	5,0	1,0	6,0	12,5	4,7	6	55	4	▲
DSTC.4.06.02.055.06	6,0	0,2	6,0	15,5	5,6	6	55	4	▲
DSTC.4.06.05.055.06	6,0	0,5	6,0	15,5	5,6	6	55	4	▲
DSTC.4.06.10.055.06	6,0	1,0	6,0	15,5	5,6	6	55	4	▲
DSTC.5.08.02.063.08	8,0	0,2	10,0	20,5	7,4	8	63	5	▲
DSTC.5.08.05.063.08	8,0	0,5	10,0	20,5	7,4	8	63	5	▲
DSTC.5.08.10.063.08	8,0	1,0	10,0	20,5	7,4	8	63	5	▲
DSTC.5.08.15.063.08	8,0	1,5	10,0	20,5	7,4	8	63	5	▲
DSTC.5.10.02.077.10	10,0	0,2	15,0	25,5	9,4	10	77	5	▲
DSTC.5.10.05.077.10	10,0	0,5	15,0	25,5	9,4	10	77	5	▲
DSTC.5.10.10.077.10	10,0	1,0	15,0	25,5	9,4	10	77	5	Δ
DSTC.5.10.15.077.10	10,0	1,5	15,0	25,5	9,4	10	77	5	Δ
DSTC.5.12.02.077.12	12,0	0,2	18,0	30,5	11,4	12	77	5	▲
DSTC.5.12.05.077.12	12,0	0,5	18,0	30,5	11,4	12	77	5	▲
DSTC.5.12.10.077.12	12,0	1,0	18,0	30,5	11,4	12	77	5	▲
DSTC.5.12.15.077.12	12,0	1,5	18,0	30,5	11,4	12	77	5	Δ
DSTC.5.12.20.077.12	12,0	2,0	18,0	30,5	11,4	12	77	5	▲

▲ ab Lager / on stock Δ 4 Wochen / 4 weeks x auf Anfrage / upon request

● empfohlen / recommended

o bedingt einsetzbar / alternative recommendation

- nicht geeignet / not suitable

■ unbeschichtete HM-Sorten / uncoated grades

■ beschichtete HM-Sorten / coated grades

■ bestückt/Cermet / brazed/Cermet

Abmessungen in mm

Dimensions in mm



P	-
M	-
K	-
N	-
S	•
H	o



HM-Sorten  
Carbide grades

# Schnittdaten DSTC Ø 1,5 - 12 mm

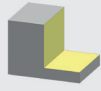
## Cutting Data DSTC Ø 1,5 - 12 mm

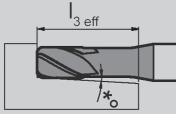

	 vc = m/min	 vc = m/min
S1	-	-
S2	45	60
S3	40	50

d <sub>1</sub>	 α	 l <sub>3 eff</sub> / * <sub>o</sub>						
			0°	f <sub>z</sub>	a <sub>e</sub>	a <sub>p</sub>	f <sub>z</sub>	a <sub>e</sub>
1,5	5°	0,3	0,014	0,30	1,50	0,019	0,08	0,15
2,0	5°	0,3	0,017	0,40	2,00	0,025	0,10	0,20
3,0	5°	0,3	0,023	0,60	3,00	0,038	0,15	0,30
3,0	5°	0,3	0,023	0,60	3,00	0,038	0,15	0,30
4,0	5°	0,3	0,024	0,80	4,00	0,039	0,20	0,40
4,0	5°	0,3	0,024	0,80	4,00	0,039	0,20	0,40
5,0	4°	0,3	0,027	1,00	5,00	0,046	0,25	0,50
5,0	4°	0,3	0,027	1,00	5,00	0,046	0,25	0,50
5,0	4°	0,3	0,027	1,00	5,00	0,046	0,25	0,50
6,0	4°	0,3	0,034	1,20	6,00	0,058	0,30	0,60
6,0	4°	0,3	0,034	1,20	6,00	0,058	0,30	0,60
6,0	4°	0,3	0,034	1,20	6,00	0,058	0,30	0,60
8,0	3°	0,3	0,045	1,60	8,00	0,080	0,40	0,80
8,0	3°	0,3	0,045	1,60	8,00	0,080	0,40	0,80
8,0	3°	0,3	0,045	1,60	8,00	0,080	0,40	0,80
8,0	3°	0,3	0,045	1,60	8,00	0,080	0,40	0,80
10,0	3°	0,3	0,057	2,00	10,00	0,106	0,50	1,00
10,0	3°	0,3	0,057	2,00	10,00	0,106	0,50	1,00
10,0	3°	0,3	0,057	2,00	10,00	0,106	0,50	1,00
10,0	3°	0,3	0,057	2,00	10,00	0,106	0,50	1,00
12,0	3°	0,3	0,070	2,40	12,00	0,132	0,60	1,20
12,0	3°	0,3	0,070	2,40	12,00	0,132	0,60	1,20
12,0	3°	0,3	0,070	2,40	12,00	0,132	0,60	1,20
12,0	3°	0,3	0,070	2,40	12,00	0,132	0,60	1,20
12,0	3°	0,3	0,070	2,40	12,00	0,132	0,60	1,20

Abmessungen in mm  
Dimensions in mm

B

# Schaftfräser Mehrschneider, Eckenradius

## End Mill multiple fluted, corner radius



### DSMRC

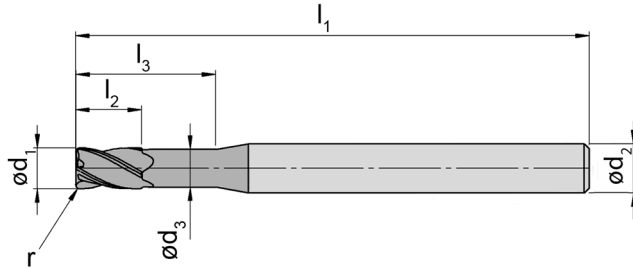
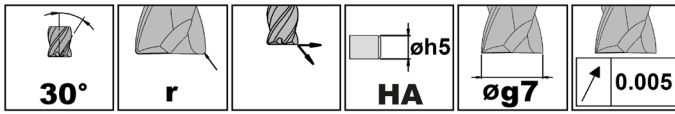

Bis Ø 3 mm vormontiert lieferbar für Toodle Schnelllaufspindel (siehe Seite D2)  
Pre-assembled available up to Ø 3 mm for Toodle high-speed spindle (see page D2)

Bestellnummer Part number	d <sub>1</sub>	r	l <sub>2</sub>	l <sub>3</sub>	d <sub>3</sub>	d <sub>2</sub>	l <sub>1</sub>	Z	TSCC
DSMRC.4.03.55.06.02	3	0,2	9,5	9,5	-	6	55	4	▲
DSMRC.4.03.55.06.3S	3	0,3	3,0	9,5	2,9	6	55	4	▲
DSMRC.4.04.55.06.02	4	0,2	12,5	12,5	-	6	55	4	▲
DSMRC.4.04.55.06.3S	4	0,3	4,0	12,5	3,9	6	55	4	▲
DSMRC.4.05.55.06.02	5	0,2	15,5	15,5	-	6	55	4	▲
DSMRC.4.05.55.06.5S	5	0,5	5,0	15,5	4,8	6	55	4	▲
DSMRC.5.06.63.06.02	6	0,2	18,5	18,5	-	6	63	5	▲
DSMRC.5.06.63.06.5S	6	0,5	6,0	18,5	5,8	6	63	5	▲
DSMRC.5.08.63.08.10	8	1,0	24,5	24,5	-	8	63	5	▲
DSMRC.5.08.63.08.5S	8	0,5	8,0	24,5	7,8	8	63	5	▲
DSMRC.5.10.77.10.10	10	1,0	30,5	30,5	-	10	77	5	▲
DSMRC.5.10.77.10.5S	10	0,5	10,0	30,5	9,8	10	77	5	▲
DSMRC.7.12.88.12.10	12	1,0	36,5	36,5	-	12	88	7	▲
DSMRC.7.12.88.12.2S	12	0,2	12,0	36,5	11,8	12	88	7	▲
DSMRC.7.16.99.16.05	16	0,5	48,5	48,5	-	16	99	7	▲
DSMRC.7.16.99.16.20	16	2,0	48,5	48,5	-	16	99	7	▲

▲ ab Lager / on stock Δ 4 Wochen / 4 weeks x auf Anfrage / upon request

● empfohlen / recommended

o bedingt einsetzbar / alternative recommendation

- nicht geeignet / not suitable

■ unbeschichtete HM-Sorten / uncoated grades

■ beschichtete HM-Sorten / coated grades

■ bestückt/Cermet / brazed/Cermet

Abmessungen in mm

Dimensions in mm

P	-
M	-
K	-
N	-
S	•
H	◦



HM-Sorten  
Carbide grades

# Schnittdaten DSMRC Ø 3 - 16 mm

## Cutting Data DSTC Ø 3 - 16 mm

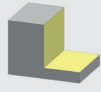
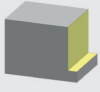

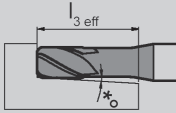
	 vc = m/min	 vc = m/min
S1	-	-
S2	45	60
S3	40	50

d <sub>1</sub>								
			0°	f <sub>z</sub>	a <sub>e</sub>	a <sub>p</sub>	f <sub>z</sub>	a <sub>e</sub>
3	3°	0,3	0,010	0,45	9,00	0,013	0,15	0,30
3	3°	0,3	0,010	0,45	3,00	0,013	0,15	0,30
4	3°	0,3	0,015	0,60	12,00	0,022	0,20	0,40
4	3°	0,3	0,015	0,60	4,00	0,022	0,20	0,40
5	3°	0,3	0,020	0,75	15,00	0,031	0,25	0,50
5	3°	0,3	0,020	0,75	5,00	0,031	0,25	0,50
6	3°	0,3	0,024	0,90	18,00	0,036	0,30	0,60
6	3°	0,3	0,024	0,90	6,00	0,036	0,30	0,60
8	3°	0,3	0,034	1,20	24,00	0,054	0,40	0,80
8	3°	0,3	0,034	1,20	8,00	0,054	0,40	0,80
10	3°	0,3	0,044	1,50	30,00	0,072	0,50	1,00
10	3°	0,3	0,044	1,50	10,00	0,072	0,50	1,00
12	3°	0,3	0,052	1,80	36,00	0,086	0,60	1,20
12	3°	0,3	0,052	1,80	12,00	0,086	0,60	1,20
16	3°	0,3	0,073	2,40	48,00	0,122	0,80	1,60
16	3°	0,3	0,073	2,40	48,00	0,122	0,80	1,60

Abmessungen in mm  
Dimensions in mm

B



# Vollhartmetall-Schaftfräser

## Solid Carbide End Mills



DSRV.4

Schaftfräser, Eckradius  
End Mill, corner radius

Ø 2 – Ø 20

Z4

B128 – B139



DSRV.5

Schaftfräser, Eckradius  
End Mill, corner radius

Ø 2 – Ø 20

Z5

B140 – B151

B

**DS**



**B**

**abgestimmt für:**

**- Titan**

**designed for:**

**- Titanium**

# Schaftfräser, Eckenradius

End Mill, corner radius



## DSRV

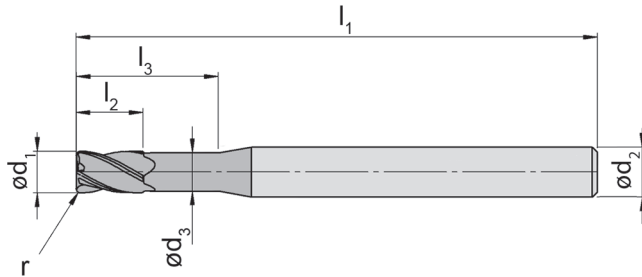
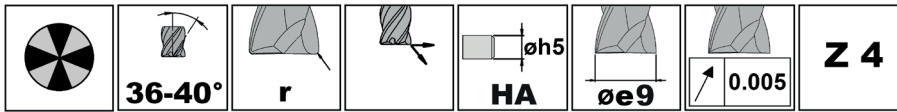

Bis Ø 3 mm vormontiert lieferbar für Toodle Schnelllaufspindel (siehe Seite D2)  
Pre-assembled available up to Ø 3 mm for Toodle high-speed spindle (see page D2)

B

Bestellnummer Part number	d <sub>1</sub>	r	l <sub>2</sub>	l <sub>3</sub>	d <sub>3</sub>	d <sub>2</sub>	l <sub>1</sub>	Z	γ	Form Form	TSTK
DSRV.4.020.010.20	2	0,1	3	4	1,90	6	50	4	40°	HA	▲
DSRV.4.020.010.30	2	0,1	5	6	1,90	6	50	4	40°	HA	▲
DSRV.4.020.020.20	2	0,2	3	4	1,90	6	50	4	40°	HA	▲
DSRV.4.020.020.30	2	0,2	5	6	1,90	6	50	4	40°	HA	▲
DSRV.4.030.010.20	3	0,1	5	6	2,85	6	50	4	40°	HA	▲
DSRV.4.030.010.30	3	0,1	7	9	2,85	6	50	4	40°	HA	▲
DSRV.4.030.020.20	3	0,2	5	6	2,85	6	50	4	40°	HA	▲
DSRV.4.030.020.30	3	0,2	7	9	2,85	6	50	4	40°	HA	▲
DSRV.4.030.050.20	3	0,5	5	6	2,85	6	50	4	40°	HA	▲
DSRV.4.030.050.30	3	0,5	7	9	2,85	6	50	4	40°	HA	▲
DSRV.4.040.010.20	4	0,1	6	8	3,80	6	50	4	40°	HA	▲
DSRV.4.040.010.30	4	0,1	9	12	3,80	6	57	4	40°	HA	▲
DSRV.4.040.020.20	4	0,2	6	8	3,80	6	50	4	40°	HA	▲
DSRV.4.040.020.30	4	0,2	9	12	3,80	6	57	4	40°	HA	▲
DSRV.4.040.050.20	4	0,5	6	8	3,80	6	50	4	40°	HA	▲
DSRV.4.040.050.30	4	0,5	9	12	3,80	6	57	4	40°	HA	▲
DSRV.4.050.010.20	5	0,1	8	10	4,75	6	50	4	40°	HA	▲
DSRV.4.050.010.30	5	0,1	11	15	4,75	6	57	4	40°	HA	▲
DSRV.4.050.020.20	5	0,2	8	10	4,75	6	50	4	40°	HA	▲
DSRV.4.050.020.30	5	0,2	11	15	4,75	6	57	4	40°	HA	▲
DSRV.4.050.050.20	5	0,5	8	10	4,75	6	50	4	40°	HA	▲
DSRV.4.050.050.30	5	0,5	11	15	4,75	6	57	4	40°	HA	▲
DSRV.4.050.100.20	5	1,0	8	10	4,75	6	50	4	40°	HA	▲
DSRV.4.050.100.30	5	1,0	11	15	4,75	6	57	4	40°	HA	▲

▲ ab Lager / on stock Δ 4 Wochen / 4 weeks x auf Anfrage / upon request

● empfohlen / recommended

o bedingt einsetzbar / alternative recommendation

- nicht geeignet / not suitable

■ unbeschichtete HM-Sorten / uncoated grades

■ beschichtete HM-Sorten / coated grades

■ bestückt/Cermet / brazed/Cermet

Abmessungen in mm

Dimensions in mm

P	•
M	•
K	o
N	-
S	•
H	-



HM-Sorten  
Carbide grades

# Schnittdaten DSRV Ø 2 - 5 mm

Cutting Data DSRV Ø 2 - 5 mm

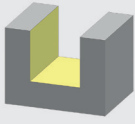
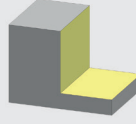
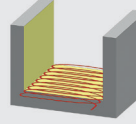

	 vc = m/min	 vc = m/min	 vc = m/min
<b>M1.1</b>	100	130	190
<b>M2.1</b>	80	100	150
<b>M3.1</b>	70	90	130
<b>S1.1</b>	60	80	120
<b>S2.1</b>	40	50	70
<b>S3.1</b>	33	40	60

d <sub>1</sub>	 α									
		f <sub>z</sub>	a <sub>e</sub>	a <sub>p</sub>	f <sub>z</sub>	a <sub>e</sub>	a <sub>p</sub>	f <sub>z</sub>	a <sub>e</sub>	a <sub>p</sub>
2	5°	0,008	2,00	2,00	0,009	0,40	3,00	0,038	0,10	3,00
2	5°	0,007	2,00	2,00	0,008	0,40	4,00	0,040	0,10	4,00
2	5°	0,008	2,00	2,00	0,009	0,40	3,00	0,045	0,10	3,00
2	5°	0,007	2,00	2,00	0,008	0,40	4,00	0,040	0,10	4,00
3	5°	0,012	3,00	3,00	0,016	0,60	4,50	0,066	0,15	4,50
3	5°	0,010	3,00	3,00	0,014	0,60	6,00	0,059	0,15	6,00
3	5°	0,012	3,00	3,00	0,016	0,60	4,50	0,066	0,15	4,50
3	5°	0,010	3,00	3,00	0,014	0,60	6,00	0,059	0,15	6,00
3	5°	0,012	3,00	3,00	0,016	0,60	4,50	0,066	0,15	4,50
3	5°	0,010	3,00	3,00	0,014	0,60	6,00	0,059	0,15	6,00
4	5°	0,016	4,00	4,00	0,022	0,80	6,00	0,087	0,20	6,00
4	5°	0,013	4,00	4,00	0,020	0,80	8,00	0,079	0,20	8,00
4	5°	0,016	4,00	4,00	0,022	0,80	6,00	0,087	0,20	6,00
4	5°	0,013	4,00	4,00	0,020	0,80	8,00	0,079	0,20	8,00
4	5°	0,016	4,00	4,00	0,022	0,80	6,00	0,087	0,20	6,00
4	5°	0,013	4,00	4,00	0,020	0,80	8,00	0,079	0,20	8,00
5	5°	0,020	5,00	5,00	0,029	1,00	7,50	0,109	0,25	7,50
5	5°	0,016	5,00	5,00	0,026	1,00	10,00	0,098	0,25	10,00
5	5°	0,020	5,00	5,00	0,029	1,00	7,50	0,109	0,25	7,50
5	5°	0,016	5,00	5,00	0,026	1,00	10,00	0,098	0,25	10,00
5	5°	0,020	5,00	5,00	0,029	1,00	7,50	0,109	0,25	7,50
5	5°	0,016	5,00	5,00	0,026	1,00	10,00	0,098	0,25	10,00
5	5°	0,020	5,00	5,00	0,029	1,00	7,50	0,109	0,25	7,50
5	5°	0,016	5,00	5,00	0,026	1,00	10,00	0,098	0,25	10,00

Abmessungen in mm  
Dimensions in mm

B

# Schaftfräser, Eckenradius

End Mill, corner radius



## DSRV

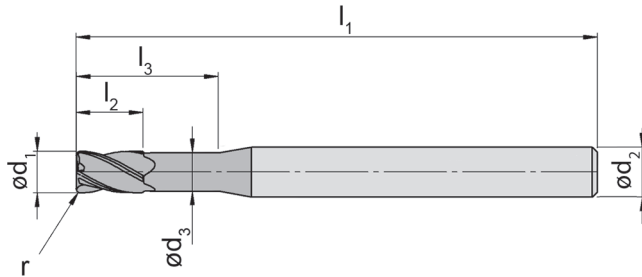
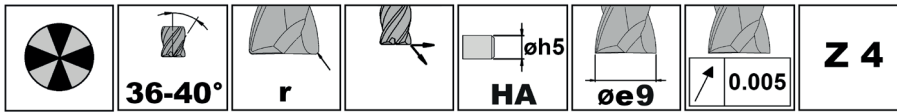

B

Bestellnummer Part number	d <sub>1</sub>	r	l <sub>2</sub>	l <sub>3</sub>	d <sub>3</sub>	d <sub>2</sub>	l <sub>1</sub>	Z	Form Form	TSTK
DSRV.4.060.010.20	6	0,1	9	12	5,7	6	50	4	HA	▲
DSRV.4.060.010.30	6	0,1	13	18	5,7	6	57	4	HA	▲
DSRV.4.060.020.20	6	0,2	9	12	5,7	6	50	4	HA	▲
DSRV.4.060.020.30	6	0,2	13	18	5,7	6	57	4	HA	▲
DSRV.4.060.050.20	6	0,5	9	12	5,7	6	50	4	HA	▲
DSRV.4.060.050.30	6	0,5	13	18	5,7	6	57	4	HA	▲
DSRV.4.060.100.30	6	1,0	13	18	5,7	6	57	4	HA	▲
DSRV.4.060.100.20	6	1,0	9	12	5,7	6	50	4	HA	▲
DSRV.4.080.010.20	8	0,1	12	16	7,6	8	58	4	HA	▲
DSRV.4.080.010.30	8	0,1	17	24	7,6	8	63	4	HA	▲
DSRV.4.080.020.20	8	0,2	12	16	7,6	8	58	4	HA	▲
DSRV.4.080.020.30	8	0,2	17	24	7,6	8	63	4	HA	▲
DSRV.4.080.050.20	8	0,5	12	16	7,6	8	58	4	HA	▲
DSRV.4.080.050.30	8	0,5	17	24	7,6	8	63	4	HA	▲
DSRV.4.080.100.20	8	1,0	12	16	7,6	8	58	4	HA	▲
DSRV.4.080.100.30	8	1,0	17	24	7,6	8	63	4	HA	▲
DSRV.4.080.150.20	8	1,5	12	16	7,6	8	58	4	HA	▲
DSRV.4.080.150.30	8	1,5	17	24	7,6	8	63	4	HA	▲

▲ ab Lager / on stock Δ 4 Wochen / 4 weeks x auf Anfrage / upon request

● empfohlen / recommended

o bedingt einsetzbar / alternative recommendation

- nicht geeignet / not suitable

■ unbeschichtete HM-Sorten / uncoated grades

■ beschichtete HM-Sorten / coated grades

■ bestückt/Cermet / brazed/Cermet

Abmessungen in mm

Dimensions in mm

P	•
M	•
K	o
N	-
S	•
H	-





HM-Sorten  
Carbide grades

# Schnittdaten DSRV Ø 6 - 8 mm

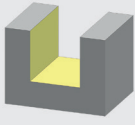
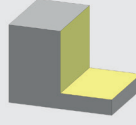
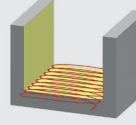
Cutting Data DSRV Ø 6 - 8 mm



	 vc = m/min	 vc = m/min	 vc = m/min
<b>M1.1</b>	100	130	190
<b>M2.1</b>	80	100	150
<b>M3.1</b>	70	90	130
<b>S1.1</b>	60	80	120
<b>S2.1</b>	40	50	70
<b>S3.1</b>	33	40	60

d <sub>1</sub>										
		f <sub>z</sub>	a <sub>e</sub>	a <sub>p</sub>	f <sub>z</sub>	a <sub>e</sub>	a <sub>p</sub>	f <sub>z</sub>	a <sub>e</sub>	a <sub>p</sub>
6	5°	0,024	6,00	6,00	0,035	1,20	9,00	0,130	0,30	9,00
6	5°	0,020	6,00	6,00	0,031	1,20	12,00	0,117	0,30	12,00
6	5°	0,024	6,00	6,00	0,035	1,20	9,00	0,130	0,30	9,00
6	5°	0,020	6,00	6,00	0,031	1,20	12,00	0,117	0,30	12,00
6	5°	0,024	6,00	6,00	0,035	1,20	9,00	0,130	0,30	9,00
6	5°	0,020	6,00	6,00	0,031	1,20	12,00	0,117	0,30	12,00
6	5°	0,024	6,00	6,00	0,035	1,20	9,00	0,130	0,30	9,00
6	5°	0,020	6,00	6,00	0,031	1,20	12,00	0,117	0,30	12,00
8	5°	0,032	8,00	8,00	0,048	1,60	12,00	0,172	0,40	12,00
8	5°	0,026	8,00	8,00	0,043	1,60	16,00	0,155	0,40	16,00
8	5°	0,032	8,00	8,00	0,048	1,60	12,00	0,172	0,40	12,00
8	5°	0,026	8,00	8,00	0,043	1,60	16,00	0,155	0,40	16,00
8	5°	0,032	8,00	8,00	0,048	1,60	12,00	0,172	0,40	12,00
8	5°	0,026	8,00	8,00	0,043	1,60	16,00	0,155	0,40	16,00
8	5°	0,032	8,00	8,00	0,048	1,60	12,00	0,172	0,40	12,00
8	5°	0,026	8,00	8,00	0,043	1,60	16,00	0,155	0,40	16,00
8	5°	0,032	8,00	8,00	0,048	1,60	12,00	0,172	0,40	12,00
8	5°	0,026	8,00	8,00	0,043	1,60	16,00	0,155	0,40	16,00

Abmessungen in mm  
Dimensions in mm

B

# Schaftfräser, Eckenradius

End Mil, corner radius



## DSRV

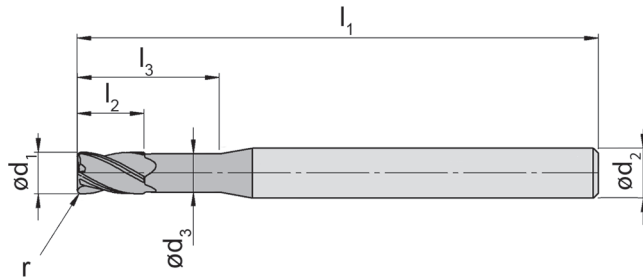
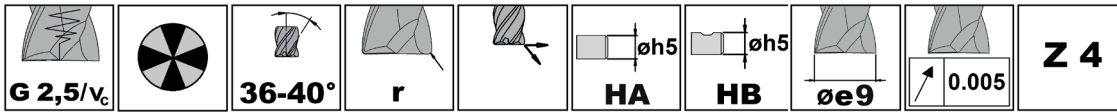

B

Bestellnummer Part number	d <sub>1</sub>	r	l <sub>2</sub>	l <sub>3</sub>	d <sub>3</sub>	d <sub>2</sub>	l <sub>1</sub>	Z	Form Form	TSTK
DSRV.4.100.010.20	10	0,1	15	20	9,5	10	66	4	HA	▲
DSRV.4.100.010.20B	10	0,1	15	20	9,5	10	66	4	HB	▲
DSRV.4.100.010.30	10	0,1	21	30	9,5	10	72	4	HA	▲
DSRV.4.100.010.30B	10	0,1	21	30	9,5	10	72	4	HB	▲
DSRV.4.100.020.20	10	0,2	15	20	9,5	10	66	4	HA	▲
DSRV.4.100.020.20B	10	0,2	15	20	9,5	10	66	4	HB	▲
DSRV.4.100.020.30	10	0,2	21	30	9,5	10	72	4	HA	▲
DSRV.4.100.020.30B	10	0,2	21	30	9,5	10	72	4	HB	▲
DSRV.4.100.050.20	10	0,5	15	20	9,5	10	66	4	HA	▲
DSRV.4.100.050.20B	10	0,5	15	20	9,5	10	66	4	HB	▲
DSRV.4.100.050.30	10	0,5	21	30	9,5	10	72	4	HA	▲
DSRV.4.100.050.30B	10	0,5	21	30	9,5	10	72	4	HB	▲
DSRV.4.100.100.20	10	1,0	15	20	9,5	10	66	4	HA	▲
DSRV.4.100.100.20B	10	1,0	15	20	9,5	10	66	4	HB	▲
DSRV.4.100.100.30	10	1,0	21	30	9,5	10	72	4	HA	▲
DSRV.4.100.100.30B	10	1,0	21	30	9,5	10	72	4	HB	▲
DSRV.4.100.150.20	10	1,5	15	20	9,5	10	66	4	HA	▲
DSRV.4.100.150.20B	10	1,5	15	20	9,5	10	66	4	HB	▲
DSRV.4.100.150.30	10	1,5	21	30	9,5	10	72	4	HA	▲
DSRV.4.100.150.30B	10	1,5	21	30	9,5	10	72	4	HB	▲
DSRV.4.100.200.20	10	2,0	15	20	9,5	10	66	4	HA	▲
DSRV.4.100.200.20B	10	2,0	15	20	9,5	10	66	4	HB	▲
DSRV.4.100.200.30	10	2,0	21	30	9,5	10	72	4	HA	▲
DSRV.4.100.200.30B	10	2,0	21	30	9,5	10	72	4	HB	▲
DSRV.4.100.250.20	10	2,5	15	20	9,5	10	66	4	HA	▲
DSRV.4.100.250.20B	10	2,5	15	20	9,5	10	66	4	HB	▲
DSRV.4.100.250.30	10	2,5	21	30	9,5	10	72	4	HA	▲
DSRV.4.100.250.30B	10	2,5	21	30	9,5	10	72	4	HB	▲
DSRV.4.100.300.20	10	3,0	15	20	9,5	10	66	4	HA	▲
DSRV.4.100.300.20B	10	3,0	15	20	9,5	10	66	4	HB	▲
DSRV.4.100.300.30	10	3,0	21	30	9,5	10	72	4	HA	▲
DSRV.4.100.300.30B	10	3,0	21	30	9,5	10	72	4	HB	▲

▲ ab Lager / on stock Δ 4 Wochen / 4 weeks x auf Anfrage / upon request

● empfohlen / recommended

o bedingt einsetzbar / alternative recommendation

- nicht geeignet / not suitable

■ unbeschichtete HM-Sorten / uncoated grades

■ beschichtete HM-Sorten / coated grades

■ bestückt/Cermet / brazed/Cermet

Abmessungen in mm

Dimensions in mm





P	•
M	•
K	•
N	-
S	•
H	-

# Schnittdaten DSRV Ø 10 mm

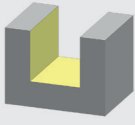
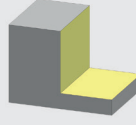
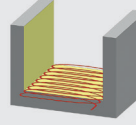
## Cutting Data DSRV Ø 10 mm



	 vc = m/min	 vc = m/min	 vc = m/min
<b>M1.1</b>	100	130	190
<b>M2.1</b>	80	100	150
<b>M3.1</b>	70	90	130
<b>S1.1</b>	60	80	120
<b>S2.1</b>	40	50	70
<b>S3.1</b>	33	40	60

d <sub>1</sub>	 α									
		f <sub>z</sub>	a <sub>e</sub>	a <sub>p</sub>	f <sub>z</sub>	a <sub>e</sub>	a <sub>p</sub>	f <sub>z</sub>	a <sub>e</sub>	a <sub>p</sub>
10	5°	0,040	10,00	10,00	0,060	2,00	15,00	0,215	0,50	15,00
10	5°	0,040	10,00	10,00	0,060	2,00	15,00	0,215	0,50	15,00
10	5°	0,032	10,00	10,00	0,054	2,00	20,00	0,194	0,50	20,00
10	5°	0,032	10,00	10,00	0,054	2,00	20,00	0,194	0,50	20,00
10	5°	0,040	10,00	10,00	0,060	2,00	15,00	0,215	0,50	15,00
10	5°	0,040	10,00	10,00	0,060	2,00	15,00	0,215	0,50	15,00
10	5°	0,032	10,00	10,00	0,054	2,00	20,00	0,194	0,50	20,00
10	5°	0,032	10,00	10,00	0,054	2,00	20,00	0,194	0,50	20,00
10	5°	0,040	10,00	10,00	0,060	2,00	15,00	0,215	0,50	15,00
10	5°	0,040	10,00	10,00	0,060	2,00	15,00	0,215	0,50	15,00
10	5°	0,032	10,00	10,00	0,054	2,00	20,00	0,194	0,50	20,00
10	5°	0,032	10,00	10,00	0,054	2,00	20,00	0,194	0,50	20,00
10	5°	0,040	10,00	10,00	0,060	2,00	15,00	0,215	0,50	15,00
10	5°	0,040	10,00	10,00	0,060	2,00	15,00	0,215	0,50	15,00
10	5°	0,032	10,00	10,00	0,054	2,00	20,00	0,194	0,50	20,00
10	5°	0,032	10,00	10,00	0,054	2,00	20,00	0,194	0,50	20,00
10	5°	0,040	10,00	10,00	0,060	2,00	15,00	0,215	0,50	15,00
10	5°	0,040	10,00	10,00	0,060	2,00	15,00	0,215	0,50	15,00
10	5°	0,032	10,00	10,00	0,054	2,00	20,00	0,194	0,50	20,00
10	5°	0,032	10,00	10,00	0,054	2,00	20,00	0,194	0,50	20,00
10	5°	0,040	10,00	10,00	0,060	2,00	15,00	0,215	0,50	15,00
10	5°	0,040	10,00	10,00	0,060	2,00	15,00	0,215	0,50	15,00
10	5°	0,032	10,00	10,00	0,054	2,00	20,00	0,194	0,50	20,00
10	5°	0,032	10,00	10,00	0,054	2,00	20,00	0,194	0,50	20,00
10	5°	0,040	10,00	10,00	0,060	2,00	15,00	0,215	0,50	15,00
10	5°	0,040	10,00	10,00	0,060	2,00	15,00	0,215	0,50	15,00
10	5°	0,032	10,00	10,00	0,054	2,00	20,00	0,194	0,50	20,00
10	5°	0,032	10,00	10,00	0,054	2,00	20,00	0,194	0,50	20,00
10	5°	0,040	10,00	10,00	0,060	2,00	15,00	0,215	0,50	15,00
10	5°	0,040	10,00	10,00	0,060	2,00	15,00	0,215	0,50	15,00
10	5°	0,032	10,00	10,00	0,054	2,00	20,00	0,194	0,50	20,00
10	5°	0,032	10,00	10,00	0,054	2,00	20,00	0,194	0,50	20,00

**B**

Abmessungen in mm  
Dimensions in mm



# Schaftfräser, Eckenradius

End Mil, corner radius



## DSRV

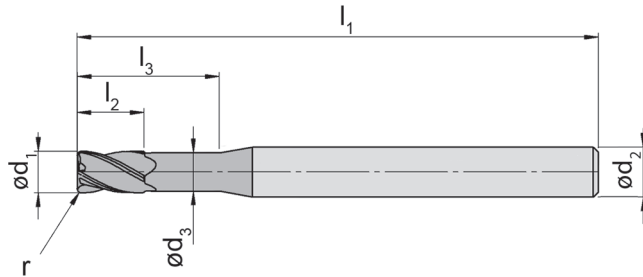
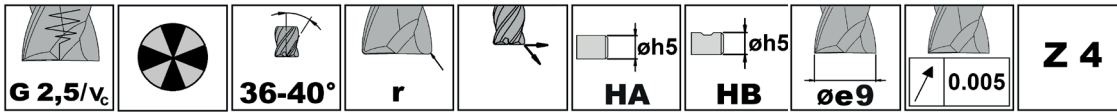

B

Bestellnummer Part number	d <sub>1</sub>	r	l <sub>2</sub>	l <sub>3</sub>	d <sub>3</sub>	d <sub>2</sub>	l <sub>1</sub>	Z	Form Form	TSTK
DSRV.4.120.020.20	12	0,2	18	24	11,4	12	73	4	HA	▲
DSRV.4.120.020.20B	12	0,2	18	24	11,4	12	73	4	HB	▲
DSRV.4.120.020.30	12	0,2	26	36	11,4	12	83	4	HA	▲
DSRV.4.120.020.30B	12	0,2	26	36	11,4	12	83	4	HB	▲
DSRV.4.120.050.20	12	0,5	18	24	11,4	12	73	4	HA	▲
DSRV.4.120.050.20B	12	0,5	18	24	11,4	12	73	4	HB	▲
DSRV.4.120.050.30	12	0,5	26	36	11,4	12	83	4	HA	▲
DSRV.4.120.050.30B	12	0,5	26	36	11,4	12	83	4	HB	▲
DSRV.4.120.100.20	12	1,0	18	24	11,4	12	73	4	HA	▲
DSRV.4.120.100.20B	12	1,0	18	24	11,4	12	73	4	HB	▲
DSRV.4.120.100.30	12	1,0	26	36	11,4	12	83	4	HA	▲
DSRV.4.120.100.30B	12	1,0	26	36	11,4	12	83	4	HB	▲
DSRV.4.120.150.20	12	1,5	18	24	11,4	12	73	4	HA	▲
DSRV.4.120.150.20B	12	1,5	18	24	11,4	12	73	4	HB	▲
DSRV.4.120.150.30	12	1,5	26	36	11,4	12	83	4	HA	▲
DSRV.4.120.150.30B	12	1,5	26	36	11,4	12	83	4	HB	▲
DSRV.4.120.200.20	12	2,0	18	24	11,4	12	73	4	HA	▲
DSRV.4.120.200.20B	12	2,0	18	24	11,4	12	73	4	HB	▲
DSRV.4.120.200.30	12	2,0	26	36	11,4	12	83	4	HA	▲
DSRV.4.120.200.30B	12	2,0	26	36	11,4	12	83	4	HB	▲
DSRV.4.120.250.20	12	2,5	18	24	11,4	12	73	4	HA	▲
DSRV.4.120.250.20B	12	2,5	18	24	11,4	12	73	4	HB	▲
DSRV.4.120.250.30	12	2,5	26	36	11,4	12	83	4	HA	▲
DSRV.4.120.250.30B	12	2,5	26	36	11,4	12	83	4	HB	▲
DSRV.4.120.300.30	12	3,0	26	36	11,4	12	83	4	HA	▲
DSRV.4.120.300.30B	12	3,0	26	36	11,4	12	83	4	HB	▲
DSRV.4.120.300.20	12	3,0	18	24	11,4	12	73	4	HA	▲
DSRV.4.120.300.20B	12	3,0	18	24	11,4	12	73	4	HB	▲

▲ ab Lager / on stock   Δ 4 Wochen / 4 weeks   x auf Anfrage / upon request

● empfohlen / recommended

o bedingt einsetzbar / alternative recommendation

- nicht geeignet / not suitable

■ unbeschichtete HM-Sorten / uncoated grades

■ beschichtete HM-Sorten / coated grades

■ bestückt/Cermet / brazed/Cermet

Abmessungen in mm

Dimensions in mm

P	•
M	•
K	○
N	-
S	•
H	-





HM-Sorten  
Carbide grades

# Schnittdaten DSRV Ø 12 mm

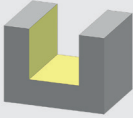
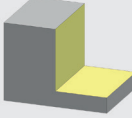
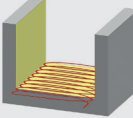
## Cutting Data DSRV Ø 12 mm



	 $vc = m/min$	 $vc = m/min$	 $vc = m/min$
<b>M1.1</b>	100	130	190
<b>M2.1</b>	80	100	150
<b>M3.1</b>	70	90	130
<b>S1.1</b>	60	80	120
<b>S2.1</b>	40	50	70
<b>S3.1</b>	33	40	60

$d_1$										
		$f_z$	$a_e$	$a_p$	$f_z$	$a_e$	$a_p$	$f_z$	$a_e$	$a_p$
12	5°	0,048	12,00	12,00	0,073	2,40	18,00	0,258	0,60	18,00
12	5°	0,048	12,00	12,00	0,073	2,40	18,00	0,258	0,60	18,00
12	5°	0,039	12,00	12,00	0,066	2,40	24,00	0,232	0,60	24,00
12	5°	0,039	12,00	12,00	0,066	2,40	24,00	0,232	0,60	24,00
12	5°	0,048	12,00	12,00	0,073	2,40	18,00	0,258	0,60	18,00
12	5°	0,048	12,00	12,00	0,073	2,40	18,00	0,258	0,60	18,00
12	5°	0,039	12,00	12,00	0,066	2,40	24,00	0,232	0,60	24,00
12	5°	0,039	12,00	12,00	0,066	2,40	24,00	0,232	0,60	24,00
12	5°	0,048	12,00	12,00	0,073	2,40	18,00	0,258	0,60	18,00
12	5°	0,048	12,00	12,00	0,073	2,40	18,00	0,258	0,60	18,00
12	5°	0,039	12,00	12,00	0,066	2,40	24,00	0,232	0,60	24,00
12	5°	0,039	12,00	12,00	0,066	2,40	24,00	0,232	0,60	24,00
12	5°	0,048	12,00	12,00	0,073	2,40	18,00	0,258	0,60	18,00
12	5°	0,048	12,00	12,00	0,073	2,40	18,00	0,258	0,60	18,00
12	5°	0,039	12,00	12,00	0,066	2,40	24,00	0,232	0,60	24,00
12	5°	0,039	12,00	12,00	0,066	2,40	24,00	0,232	0,60	24,00
12	5°	0,048	12,00	12,00	0,073	2,40	18,00	0,258	0,60	18,00
12	5°	0,048	12,00	12,00	0,073	2,40	18,00	0,258	0,60	18,00
12	5°	0,039	12,00	12,00	0,066	2,40	24,00	0,232	0,60	24,00
12	5°	0,039	12,00	12,00	0,066	2,40	24,00	0,232	0,60	24,00
12	5°	0,048	12,00	12,00	0,073	2,40	18,00	0,258	0,60	18,00
12	5°	0,048	12,00	12,00	0,073	2,40	18,00	0,258	0,60	18,00
12	5°	0,039	12,00	12,00	0,066	2,40	24,00	0,232	0,60	24,00
12	5°	0,039	12,00	12,00	0,066	2,40	24,00	0,232	0,60	24,00
12	5°	0,048	12,00	12,00	0,073	2,40	18,00	0,258	0,60	18,00
12	5°	0,048	12,00	12,00	0,073	2,40	18,00	0,258	0,60	18,00
12	5°	0,039	12,00	12,00	0,066	2,40	24,00	0,232	0,60	24,00
12	5°	0,039	12,00	12,00	0,066	2,40	24,00	0,232	0,60	24,00

Abmessungen in mm  
Dimensions in mm

**B**

# Schaftfräser, Eckenradius

End Mil, corner radius



## DSRV

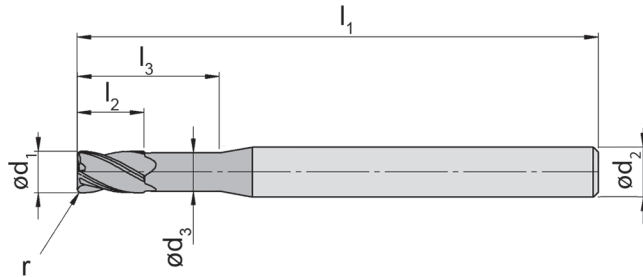
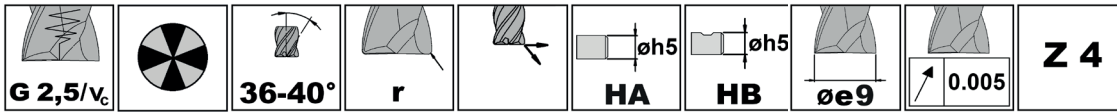

B

Bestellnummer Part number	d <sub>1</sub>	r	l <sub>2</sub>	l <sub>3</sub>	d <sub>3</sub>	d <sub>2</sub>	l <sub>1</sub>	Z	Form Form	TSTK
DSRV.4.160.020.20	16	0,2	24	32	15,2	16	82	4	HA	▲
DSRV.4.160.020.20B	16	0,2	24	32	15,2	16	82	4	HB	▲
DSRV.4.160.020.30	16	0,2	34	48	15,2	16	100	4	HA	▲
DSRV.4.160.020.30B	16	0,2	34	48	15,2	16	100	4	HB	▲
DSRV.4.160.050.20	16	0,5	24	32	15,2	16	82	4	HA	▲
DSRV.4.160.050.20B	16	0,5	24	32	15,2	16	82	4	HB	▲
DSRV.4.160.050.30	16	0,5	34	48	15,2	16	100	4	HA	▲
DSRV.4.160.050.30B	16	0,5	34	48	15,2	16	100	4	HB	▲
DSRV.4.160.100.20	16	1,0	24	32	15,2	16	82	4	HA	▲
DSRV.4.160.100.20B	16	1,0	24	32	15,2	16	82	4	HB	▲
DSRV.4.160.100.30	16	1,0	34	48	15,2	16	100	4	HA	▲
DSRV.4.160.100.30B	16	1,0	34	48	15,2	16	100	4	HB	▲
DSRV.4.160.150.20	16	1,5	24	32	15,2	16	82	4	HA	▲
DSRV.4.160.150.30	16	1,5	34	48	15,2	16	100	4	HA	▲
DSRV.4.160.150.20B	16	1,5	24	32	15,2	16	82	4	HB	▲
DSRV.4.160.150.30B	16	1,5	34	48	15,2	16	100	4	HB	▲
DSRV.4.160.200.20	16	2,0	24	32	15,2	16	82	4	HA	▲
DSRV.4.160.200.20B	16	2,0	24	32	15,2	16	82	4	HB	▲
DSRV.4.160.200.30	16	2,0	34	48	15,2	16	100	4	HA	▲
DSRV.4.160.200.30B	16	2,0	34	48	15,2	16	100	4	HB	▲
DSRV.4.160.250.20	16	2,5	24	32	15,2	16	82	4	HA	▲
DSRV.4.160.250.20B	16	2,5	24	32	15,2	16	82	4	HB	▲
DSRV.4.160.250.30	16	2,5	34	48	15,2	16	100	4	HA	▲
DSRV.4.160.250.30B	16	2,5	34	48	15,2	16	100	4	HB	▲
DSRV.4.160.300.20	16	3,0	24	32	15,2	16	82	4	HA	▲
DSRV.4.160.300.20B	16	3,0	24	32	15,2	16	82	4	HB	▲
DSRV.4.160.300.30	16	3,0	34	48	15,2	16	100	4	HA	▲
DSRV.4.160.300.30B	16	3,0	34	48	15,2	16	100	4	HB	▲
DSRV.4.160.400.20	16	4,0	24	32	15,2	16	82	4	HA	▲
DSRV.4.160.400.20B	16	4,0	24	32	15,2	16	82	4	HB	▲
DSRV.4.160.400.30	16	4,0	34	48	15,2	16	100	4	HA	▲
DSRV.4.160.400.30B	16	4,0	34	48	15,2	16	100	4	HB	▲

▲ ab Lager / on stock Δ 4 Wochen / 4 weeks x auf Anfrage / upon request

● empfohlen / recommended

o bedingt einsetzbar / alternative recommendation

- nicht geeignet / not suitable

■ unbeschichtete HM-Sorten / uncoated grades

■ beschichtete HM-Sorten / coated grades

■ bestückt/Cermet / brazed/Cermet

Abmessungen in mm

Dimensions in mm

P	•
M	•
K	◦
N	-
S	•
H	-



# Schaftfräser, Eckenradius

End Mill, corner radius



## DSRV

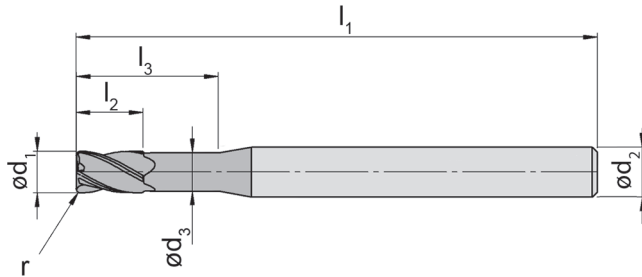
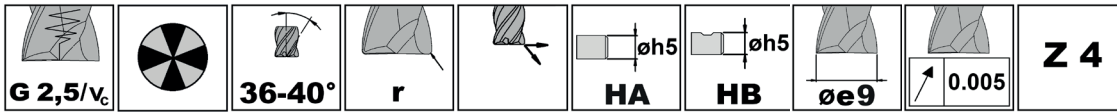

B

Bestellnummer Part number	d <sub>1</sub>	r	l <sub>2</sub>	l <sub>3</sub>	d <sub>3</sub>	d <sub>2</sub>	l <sub>1</sub>	Z	Form Form	TSTK
DSRV.4.200.020.20	20	0,2	30	40	19	20	92	4	HA	▲
DSRV.4.200.020.20B	20	0,2	30	40	19	20	92	4	HB	▲
DSRV.4.200.020.30	20	0,2	42	60	19	20	120	4	HA	▲
DSRV.4.200.020.30B	20	0,2	42	60	19	20	120	4	HB	▲
DSRV.4.200.050.20	20	0,5	30	40	19	20	92	4	HA	▲
DSRV.4.200.050.20B	20	0,5	30	40	19	20	92	4	HB	▲
DSRV.4.200.050.30	20	0,5	42	60	19	20	120	4	HA	▲
DSRV.4.200.050.30B	20	0,5	42	60	19	20	120	4	HB	▲
DSRV.4.200.100.20	20	1,0	30	40	19	20	92	4	HA	▲
DSRV.4.200.100.20B	20	1,0	30	40	19	20	92	4	HB	▲
DSRV.4.200.100.30	20	1,0	42	60	19	20	120	4	HA	▲
DSRV.4.200.100.30B	20	1,0	42	60	19	20	120	4	HB	▲
DSRV.4.200.150.20	20	1,5	30	40	19	20	92	4	HA	▲
DSRV.4.200.150.20B	20	1,5	30	40	19	20	92	4	HB	▲
DSRV.4.200.150.30	20	1,5	42	60	19	20	120	4	HA	▲
DSRV.4.200.150.30B	20	1,5	42	60	19	20	120	4	HB	▲
DSRV.4.200.200.20	20	2,0	30	40	19	20	92	4	HA	▲
DSRV.4.200.200.20B	20	2,0	30	40	19	20	92	4	HB	▲
DSRV.4.200.200.30	20	2,0	42	60	19	20	120	4	HA	▲
DSRV.4.200.200.30B	20	2,0	42	60	19	20	120	4	HB	▲
DSRV.4.200.250.20	20	2,5	30	40	19	20	92	4	HA	▲
DSRV.4.200.250.20B	20	2,5	30	40	19	20	92	4	HB	▲
DSRV.4.200.250.30	20	2,5	42	60	19	20	120	4	HA	▲
DSRV.4.200.250.30B	20	2,5	42	60	19	20	120	4	HB	▲
DSRV.4.200.300.20	20	3,0	30	40	19	20	92	4	HA	▲
DSRV.4.200.300.20B	20	3,0	30	40	19	20	92	4	HB	▲
DSRV.4.200.300.30	20	3,0	42	60	19	20	120	4	HA	▲
DSRV.4.200.300.30B	20	3,0	42	60	19	20	120	4	HB	▲
DSRV.4.200.400.20	20	4,0	30	40	19	20	92	4	HA	▲
DSRV.4.200.400.20B	20	4,0	30	40	19	20	92	4	HB	▲
DSRV.4.200.400.30	20	4,0	42	60	19	20	120	4	HA	▲
DSRV.4.200.400.30B	20	4,0	42	60	19	20	120	4	HB	▲

▲ ab Lager / on stock Δ 4 Wochen / 4 weeks x auf Anfrage / upon request

● empfohlen / recommended

o bedingt einsetzbar / alternative recommendation

- nicht geeignet / not suitable

■ unbeschichtete HM-Sorten / uncoated grades

■ beschichtete HM-Sorten / coated grades

■ bestückt/Cermet / brazed/Cermet

Abmessungen in mm

Dimensions in mm





P	•
M	•
K	o
N	-
S	•
H	-

# Schnittdaten DSRV Ø 20 mm

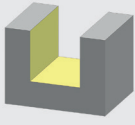
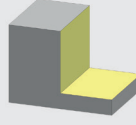
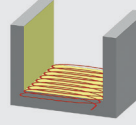
## Cutting Data DSRV Ø 20 mm



	 vc = m/min	 vc = m/min	 vc = m/min
<b>M1.1</b>	100	130	190
<b>M2.1</b>	80	100	150
<b>M3.1</b>	70	90	130
<b>S1.1</b>	60	80	120
<b>S2.1</b>	40	50	70
<b>S3.1</b>	33	40	60

d <sub>1</sub>										
		f <sub>z</sub>	a <sub>e</sub>	a <sub>p</sub>	f <sub>z</sub>	a <sub>e</sub>	a <sub>p</sub>	f <sub>z</sub>	a <sub>e</sub>	a <sub>p</sub>
20	5°	0,080	20,00	20,00	0,124	4,00	30,00	0,428	1,00	30,00
20	5°	0,080	20,00	20,00	0,124	4,00	30,00	0,428	1,00	30,00
20	5°	0,064	20,00	20,00	0,112	4,00	40,00	0,385	1,00	40,00
20	5°	0,064	20,00	20,00	0,112	4,00	40,00	0,385	1,00	40,00
20	5°	0,080	20,00	20,00	0,124	4,00	30,00	0,428	1,00	30,00
20	5°	0,080	20,00	20,00	0,124	4,00	30,00	0,428	1,00	30,00
20	5°	0,064	20,00	20,00	0,112	4,00	40,00	0,385	1,00	40,00
20	5°	0,064	20,00	20,00	0,112	4,00	40,00	0,385	1,00	40,00
20	5°	0,080	20,00	20,00	0,124	4,00	30,00	0,428	1,00	30,00
20	5°	0,080	20,00	20,00	0,124	4,00	30,00	0,428	1,00	30,00
20	5°	0,064	20,00	20,00	0,112	4,00	40,00	0,385	1,00	40,00
20	5°	0,064	20,00	20,00	0,112	4,00	40,00	0,385	1,00	40,00
20	5°	0,080	20,00	20,00	0,124	4,00	30,00	0,428	1,00	30,00
20	5°	0,080	20,00	20,00	0,124	4,00	30,00	0,428	1,00	30,00
20	5°	0,064	20,00	20,00	0,112	4,00	40,00	0,385	1,00	40,00
20	5°	0,064	20,00	20,00	0,112	4,00	40,00	0,385	1,00	40,00
20	5°	0,080	20,00	20,00	0,124	4,00	30,00	0,428	1,00	30,00
20	5°	0,080	20,00	20,00	0,124	4,00	30,00	0,428	1,00	30,00
20	5°	0,064	20,00	20,00	0,112	4,00	40,00	0,385	1,00	40,00
20	5°	0,064	20,00	20,00	0,112	4,00	40,00	0,385	1,00	40,00
20	5°	0,080	20,00	20,00	0,124	4,00	30,00	0,428	1,00	30,00
20	5°	0,080	20,00	20,00	0,124	4,00	30,00	0,428	1,00	30,00
20	5°	0,064	20,00	20,00	0,112	4,00	40,00	0,385	1,00	40,00
20	5°	0,064	20,00	20,00	0,112	4,00	40,00	0,385	1,00	40,00
20	5°	0,080	20,00	20,00	0,124	4,00	30,00	0,428	1,00	30,00
20	5°	0,080	20,00	20,00	0,124	4,00	30,00	0,428	1,00	30,00
20	5°	0,064	20,00	20,00	0,112	4,00	40,00	0,385	1,00	40,00
20	5°	0,064	20,00	20,00	0,112	4,00	40,00	0,385	1,00	40,00
20	5°	0,080	20,00	20,00	0,124	4,00	30,00	0,428	1,00	30,00
20	5°	0,080	20,00	20,00	0,124	4,00	30,00	0,428	1,00	30,00
20	5°	0,064	20,00	20,00	0,112	4,00	40,00	0,385	1,00	40,00
20	5°	0,064	20,00	20,00	0,112	4,00	40,00	0,404	1,00	40,00

**B**

Abmessungen in mm  
Dimensions in mm

# Schafffräser, Eckenradius

End Mill, corner radius



## DSRV

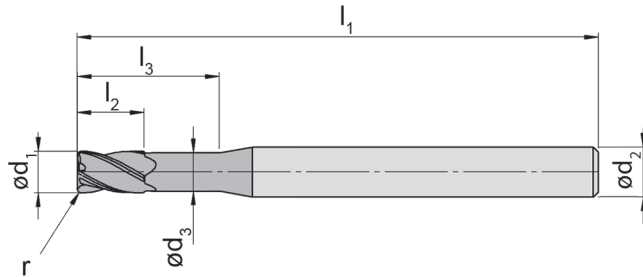
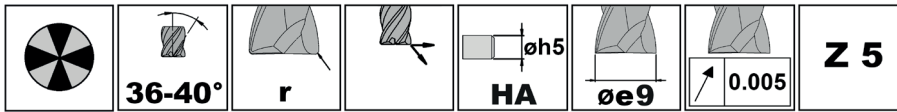

Bis Ø 3 mm vormontiert lieferbar für Toodle Schnelllaufspindel (siehe Seite D2)  
Pre-assembled available up to Ø 3 mm for Toodle high-speed spindle (see page D2)

B

Bestellnummer Part number	d <sub>1</sub>	r	l <sub>2</sub>	l <sub>3</sub>	d <sub>3</sub>	d <sub>2</sub>	l <sub>1</sub>	Z	γ	Form Form	TSTK
DSRV.5.020.010.20	2	0,1	3	4	1,90	6	50	5	40°	HA	▲
DSRV.5.020.010.30	2	0,1	5	6	1,90	6	50	5	40°	HA	▲
DSRV.5.020.020.20	2	0,2	3	4	1,90	6	50	5	40°	HA	▲
DSRV.5.020.020.30	2	0,2	5	6	1,90	6	50	5	40°	HA	▲
DSRV.5.030.010.20	3	0,1	5	6	2,85	6	50	5	40°	HA	▲
DSRV.5.030.010.30	3	0,1	7	9	2,85	6	50	5	40°	HA	▲
DSRV.5.030.020.20	3	0,2	5	6	2,85	6	50	5	40°	HA	▲
DSRV.5.030.020.30	3	0,2	7	9	2,85	6	50	5	40°	HA	▲
DSRV.5.030.050.20	3	0,5	5	6	2,85	6	50	5	40°	HA	▲
DSRV.5.030.050.30	3	0,5	7	9	2,85	6	50	5	40°	HA	▲
DSRV.5.040.010.20	4	0,1	6	8	3,80	6	50	5	40°	HA	▲
DSRV.5.040.010.30	4	0,1	9	12	3,80	6	57	5	40°	HA	▲
DSRV.5.040.020.20	4	0,2	6	8	3,80	6	50	5	40°	HA	▲
DSRV.5.040.020.30	4	0,2	9	12	3,80	6	57	5	40°	HA	▲
DSRV.5.040.050.20	4	0,5	6	8	3,80	6	50	5	40°	HA	▲
DSRV.5.040.050.30	4	0,5	9	12	3,80	6	57	5	40°	HA	▲
DSRV.5.050.010.20	5	0,1	8	10	4,75	6	50	5	40°	HA	▲
DSRV.5.050.010.30	5	0,1	11	15	4,75	6	57	5	40°	HA	▲
DSRV.5.050.020.20	5	0,2	8	10	4,75	6	50	5	40°	HA	▲
DSRV.5.050.020.30	5	0,2	11	15	4,75	6	57	5	40°	HA	▲
DSRV.5.050.050.20	5	0,5	8	10	4,75	6	50	5	40°	HA	▲
DSRV.5.050.050.30	5	0,5	11	15	4,75	6	57	5	40°	HA	▲
DSRV.5.050.100.20	5	1,0	8	10	4,75	6	50	5	40°	HA	▲
DSRV.5.050.100.30	5	1,0	11	15	4,75	6	57	5	40°	HA	▲

▲ ab Lager / on stock Δ 4 Wochen / 4 weeks x auf Anfrage / upon request

● empfohlen / recommended

o bedingt einsetzbar / alternative recommendation

- nicht geeignet / not suitable

■ unbeschichtete HM-Sorten / uncoated grades

■ beschichtete HM-Sorten / coated grades

■ bestückt/Cermet / brazed/Cermet

Abmessungen in mm

Dimensions in mm

P	•
M	•
K	o
N	-
S	•
H	-





HM-Sorten  
Carbide grades

# Schnittdaten DSRV Ø 2 - 5 mm

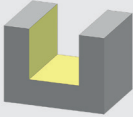
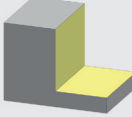
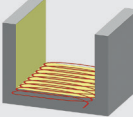
Cutting Data DSRV Ø 2 - 5 mm



	 vc = m/min	 vc = m/min	 vc = m/min
<b>M1.1</b>	100	130	190
<b>M2.1</b>	80	100	150
<b>M3.1</b>	70	90	130
<b>S1.1</b>	60	80	120
<b>S2.1</b>	40	50	70
<b>S3.1</b>	33	40	60

d <sub>1</sub>	 α									
		f <sub>z</sub>	a <sub>e</sub>	a <sub>p</sub>	f <sub>z</sub>	a <sub>e</sub>	a <sub>p</sub>	f <sub>z</sub>	a <sub>e</sub>	a <sub>p</sub>
2	3°	0,007	2,00	2,00	0,009	0,40	3,00	0,035	0,10	3,00
2	3°	0,005	2,00	2,00	0,004	0,40	4,00	0,032	0,10	4,00
2	3°	0,007	2,00	2,00	0,009	0,40	3,00	0,035	0,10	3,00
2	3°	0,005	2,00	2,00	0,004	0,40	4,00	0,032	0,10	4,00
3	3°	0,011	3,00	3,00	0,016	0,60	4,50	0,057	0,15	4,50
3	3°	0,008	3,00	3,00	0,010	0,60	6,00	0,051	0,15	6,00
3	3°	0,011	3,00	3,00	0,016	0,60	4,50	0,057	0,15	4,50
3	3°	0,008	3,00	3,00	0,010	0,60	6,00	0,051	0,15	6,00
3	3°	0,011	3,00	3,00	0,016	0,60	4,50	0,057	0,15	4,50
3	3°	0,008	3,00	3,00	0,010	0,60	6,00	0,051	0,15	6,00
4	3°	0,015	4,00	4,00	0,022	0,80	6,00	0,078	0,20	6,00
4	3°	0,012	4,00	4,00	0,016	0,80	8,00	0,070	0,20	8,00
4	3°	0,015	4,00	4,00	0,022	0,80	6,00	0,078	0,20	6,00
4	3°	0,012	4,00	4,00	0,016	0,80	8,00	0,070	0,20	8,00
4	3°	0,015	4,00	4,00	0,022	0,80	6,00	0,078	0,20	6,00
4	3°	0,012	4,00	4,00	0,016	0,80	8,00	0,070	0,20	8,00
5	3°	0,019	5,00	5,00	0,028	1,00	7,50	0,099	0,25	7,50
5	3°	0,015	5,00	5,00	0,021	1,00	10,00	0,089	0,25	10,00
5	3°	0,019	5,00	5,00	0,028	1,00	7,50	0,099	0,25	7,50
5	3°	0,015	5,00	5,00	0,021	1,00	10,00	0,089	0,25	10,00
5	3°	0,019	5,00	5,00	0,028	1,00	7,50	0,099	0,25	7,50
5	3°	0,015	5,00	5,00	0,021	1,00	10,00	0,089	0,25	10,00
5	3°	0,019	5,00	5,00	0,028	1,00	7,50	0,099	0,25	7,50
5	3°	0,015	5,00	5,00	0,021	1,00	10,00	0,089	0,25	10,00

Abmessungen in mm  
Dimensions in mm

**B**



# Schaftfräser, Eckenradius

End Mill, corner radius



## DSRV

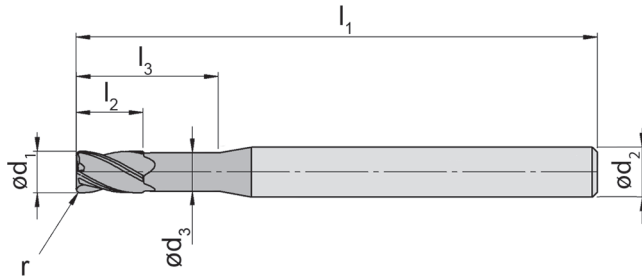
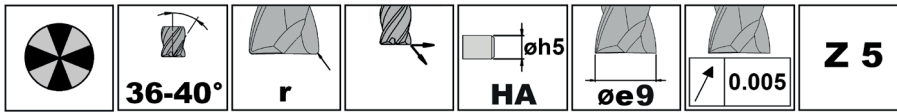

B

Bestellnummer Part number	d <sub>1</sub>	r	l <sub>2</sub>	l <sub>3</sub>	d <sub>3</sub>	d <sub>2</sub>	l <sub>1</sub>	Z	Form Form	TSTK
DSRV.5.060.010.20	6	0,1	9	12	5,7	6	50	5	HA	▲
DSRV.5.060.010.30	6	0,1	13	18	5,7	6	57	5	HA	▲
DSRV.5.060.020.20	6	0,2	9	12	5,7	6	50	5	HA	▲
DSRV.5.060.020.30	6	0,2	13	18	5,7	6	57	5	HA	▲
DSRV.5.060.050.20	6	0,5	9	12	5,7	6	50	5	HA	▲
DSRV.5.060.050.30	6	0,5	13	18	5,7	6	57	5	HA	▲
DSRV.5.060.100.20	6	1,0	9	12	5,7	6	50	5	HA	▲
DSRV.5.060.100.30	6	1,0	13	18	5,7	6	57	5	HA	▲
DSRV.5.080.010.20	8	0,1	12	16	7,6	8	58	5	HA	▲
DSRV.5.080.010.30	8	0,1	17	24	7,6	8	63	5	HA	▲
DSRV.5.080.020.20	8	0,2	12	16	7,6	8	58	5	HA	▲
DSRV.5.080.020.30	8	0,2	17	24	7,6	8	63	5	HA	▲
DSRV.5.080.050.20	8	0,5	12	16	7,6	8	58	5	HA	▲
DSRV.5.080.050.30	8	0,5	17	24	7,6	8	63	5	HA	▲
DSRV.5.080.100.20	8	1,0	12	16	7,6	8	58	5	HA	▲
DSRV.5.080.100.30	8	1,0	17	24	7,6	8	63	5	HA	▲
DSRV.5.080.150.20	8	1,5	12	16	7,6	8	58	5	HA	▲
DSRV.5.080.150.30	8	1,5	17	24	7,6	8	63	5	HA	▲

▲ ab Lager / on stock Δ 4 Wochen / 4 weeks x auf Anfrage / upon request

● empfohlen / recommended

o bedingt einsetzbar / alternative recommendation

- nicht geeignet / not suitable

■ unbeschichtete HM-Sorten / uncoated grades

■ beschichtete HM-Sorten / coated grades

■ bestückt/Cermet / brazed/Cermet

Abmessungen in mm

Dimensions in mm

P	•
M	•
K	o
N	-
S	•
H	-





HM-Sorten  
Carbide grades

# Schnittdaten DSRV Ø 6 - 8 mm

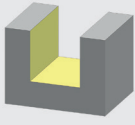
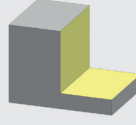
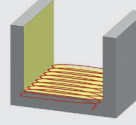
Cutting Data DSRV Ø 6 - 8 mm



	 vc = m/min	 vc = m/min	 vc = m/min
<b>M1.1</b>	100	130	190
<b>M2.1</b>	80	100	150
<b>M3.1</b>	70	90	130
<b>S1.1</b>	60	80	120
<b>S2.1</b>	40	50	70
<b>S3.1</b>	33	40	60

d <sub>1</sub>										
		f <sub>z</sub>	a <sub>e</sub>	a <sub>p</sub>	f <sub>z</sub>	a <sub>e</sub>	a <sub>p</sub>	f <sub>z</sub>	a <sub>e</sub>	a <sub>p</sub>
6	3°	0,023	6,00	6,00	0,035	1,20	9,00	0,121	0,30	9,00
6	3°	0,018	6,00	6,00	0,027	1,20	12,00	0,108	0,30	12,00
6	3°	0,023	6,00	6,00	0,035	1,20	9,00	0,121	0,30	9,00
6	3°	0,018	6,00	6,00	0,027	1,20	12,00	0,108	0,30	12,00
6	3°	0,023	6,00	6,00	0,035	1,20	9,00	0,121	0,30	9,00
6	3°	0,018	6,00	6,00	0,027	1,20	12,00	0,108	0,30	12,00
6	3°	0,023	6,00	6,00	0,035	1,20	9,00	0,121	0,30	9,00
6	3°	0,018	6,00	6,00	0,027	1,20	12,00	0,108	0,30	12,00
8	3°	0,031	8,00	8,00	0,047	1,60	12,00	0,163	0,40	12,00
8	3°	0,024	8,00	8,00	0,039	1,60	16,00	0,147	0,40	16,00
8	3°	0,031	8,00	8,00	0,047	1,60	12,00	0,163	0,40	12,00
8	3°	0,024	8,00	8,00	0,039	1,60	16,00	0,147	0,40	16,00
8	3°	0,031	8,00	8,00	0,047	1,60	12,00	0,163	0,40	12,00
8	3°	0,024	8,00	8,00	0,039	1,60	16,00	0,147	0,40	16,00
8	3°	0,031	8,00	8,00	0,047	1,60	12,00	0,163	0,40	12,00
8	3°	0,024	8,00	8,00	0,039	1,60	16,00	0,147	0,40	16,00
8	3°	0,031	8,00	8,00	0,047	1,60	12,00	0,163	0,40	12,00
8	3°	0,024	8,00	8,00	0,039	1,60	16,00	0,147	0,40	16,00

Abmessungen in mm  
Dimensions in mm

**B**

# Schaftfräser, Eckenradius

End Mil, corner radius



## DSRV

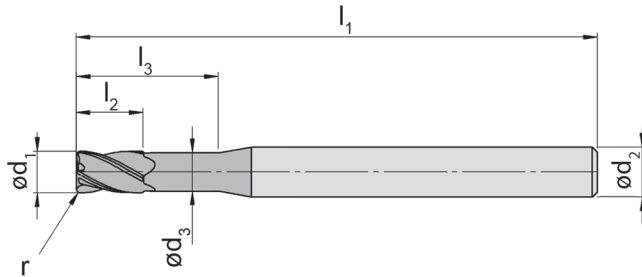
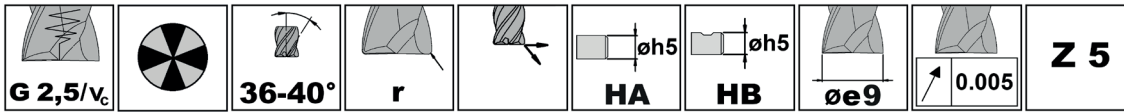

B

Bestellnummer Part number	d <sub>1</sub>	r	l <sub>2</sub>	l <sub>3</sub>	d <sub>3</sub>	d <sub>2</sub>	l <sub>1</sub>	Z	Form Form	TSTK
DSRV.5.100.010.20	10	0,1	15	20	9,5	10	66	5	HA	▲
DSRV.5.100.010.20B	10	0,1	15	20	9,5	10	66	5	HB	▲
DSRV.5.100.010.30	10	0,1	21	30	9,5	10	72	5	HA	▲
DSRV.5.100.010.30B	10	0,1	21	30	9,5	10	72	5	HB	▲
DSRV.5.100.020.20	10	0,2	15	20	9,5	10	66	5	HA	▲
DSRV.5.100.020.20B	10	0,2	15	20	9,5	10	66	5	HB	▲
DSRV.5.100.020.30	10	0,2	21	30	9,5	10	72	5	HA	▲
DSRV.5.100.020.30B	10	0,2	21	30	9,5	10	72	5	HB	▲
DSRV.5.100.050.20	10	0,5	15	20	9,5	10	66	5	HA	▲
DSRV.5.100.050.20B	10	0,5	15	20	9,5	10	66	5	HB	▲
DSRV.5.100.050.30B	10	0,5	21	30	9,5	10	72	5	HB	▲
DSRV.5.100.050.30	10	0,5	21	30	9,5	10	72	5	HA	▲
DSRV.5.100.100.20	10	1,0	15	20	9,5	10	66	5	HA	▲
DSRV.5.100.100.20B	10	1,0	15	20	9,5	10	66	5	HB	▲
DSRV.5.100.100.30	10	1,0	21	30	9,5	10	72	5	HA	▲
DSRV.5.100.100.30B	10	1,0	21	30	9,5	10	72	5	HB	▲
DSRV.5.100.150.20	10	1,5	15	20	9,5	10	66	5	HA	▲
DSRV.5.100.150.20B	10	1,5	15	20	9,5	10	66	5	HB	▲
DSRV.5.100.150.30	10	1,5	21	30	9,5	10	72	5	HA	▲
DSRV.5.100.150.30B	10	1,5	21	30	9,5	10	72	5	HB	▲
DSRV.5.100.200.20	10	2,0	15	20	9,5	10	66	5	HA	▲
DSRV.5.100.200.20B	10	2,0	15	20	9,5	10	66	5	HB	▲
DSRV.5.100.200.30	10	2,0	21	30	9,5	10	72	5	HA	▲
DSRV.5.100.200.30B	10	2,0	21	30	9,5	10	72	5	HB	▲
DSRV.5.100.250.20	10	2,5	15	20	9,5	10	66	5	HA	▲
DSRV.5.100.250.20B	10	2,5	15	20	9,5	10	66	5	HB	▲
DSRV.5.100.250.30	10	2,5	21	30	9,5	10	72	5	HA	▲
DSRV.5.100.250.30B	10	2,5	21	30	9,5	10	72	5	HB	▲
DSRV.5.100.300.20	10	3,0	15	20	9,5	10	66	5	HA	▲
DSRV.5.100.300.20B	10	3,0	15	20	9,5	10	66	5	HB	▲
DSRV.5.100.300.30	10	3,0	21	30	9,5	10	72	5	HA	▲
DSRV.5.100.300.30B	10	3,0	21	30	9,5	10	72	5	HB	▲

▲ ab Lager / on stock Δ 4 Wochen / 4 weeks x auf Anfrage / upon request

● empfohlen / recommended

o bedingt einsetzbar / alternative recommendation

- nicht geeignet / not suitable

■ unbeschichtete HM-Sorten / uncoated grades

■ beschichtete HM-Sorten / coated grades

■ bestückt/Cermet / brazed/Cermet

Abmessungen in mm

Dimensions in mm





P	●
M	●
K	○
N	-
S	●
H	-

# Schnittdaten DSRV Ø 10 mm

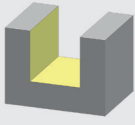
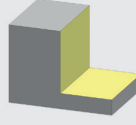
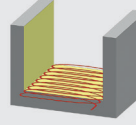
## Cutting Data DSRV Ø 10 mm



	 vc = m/min	 vc = m/min	 vc = m/min
<b>M1.1</b>	100	130	190
<b>M2.1</b>	80	100	150
<b>M3.1</b>	70	90	130
<b>S1.1</b>	60	80	120
<b>S2.1</b>	40	50	70
<b>S3.1</b>	33	40	60

d <sub>1</sub>	 α									
		f <sub>z</sub>	a <sub>e</sub>	a <sub>p</sub>	f <sub>z</sub>	a <sub>e</sub>	a <sub>p</sub>	f <sub>z</sub>	a <sub>e</sub>	a <sub>p</sub>
10	3°	0,039	10,00	10,00	0,060	2,00	15,00	0,206	0,50	15,00
10	3°	0,038	10,00	10,00	0,056	2,00	15,00	0,206	0,50	15,00
10	3°	0,032	10,00	10,00	0,054	2,00	20,00	0,185	0,50	20,00
10	3°	0,031	10,00	10,00	0,050	2,00	20,00	0,185	0,50	20,00
10	3°	0,039	10,00	10,00	0,060	2,00	15,00	0,206	0,50	15,00
10	3°	0,038	10,00	10,00	0,056	2,00	15,00	0,206	0,50	15,00
10	3°	0,032	10,00	10,00	0,054	2,00	20,00	0,185	0,50	20,00
10	3°	0,031	10,00	10,00	0,050	2,00	20,00	0,185	0,50	20,00
10	3°	0,039	10,00	10,00	0,060	2,00	15,00	0,206	0,50	15,00
10	3°	0,038	10,00	10,00	0,056	2,00	15,00	0,206	0,50	15,00
10	3°	0,032	10,00	10,00	0,054	2,00	20,00	0,185	0,50	20,00
10	3°	0,031	10,00	10,00	0,050	2,00	20,00	0,185	0,50	20,00
10	3°	0,039	10,00	10,00	0,060	2,00	15,00	0,206	0,50	15,00
10	3°	0,038	10,00	10,00	0,056	2,00	15,00	0,206	0,50	15,00
10	3°	0,032	10,00	10,00	0,054	2,00	20,00	0,185	0,50	20,00
10	3°	0,031	10,00	10,00	0,050	2,00	20,00	0,185	0,50	20,00
10	3°	0,039	10,00	10,00	0,060	2,00	15,00	0,206	0,50	15,00
10	3°	0,038	10,00	10,00	0,056	2,00	15,00	0,206	0,50	15,00
10	3°	0,032	10,00	10,00	0,054	2,00	20,00	0,185	0,50	20,00
10	3°	0,031	10,00	10,00	0,050	2,00	20,00	0,185	0,50	20,00
10	3°	0,039	10,00	10,00	0,060	2,00	15,00	0,206	0,50	15,00
10	3°	0,038	10,00	10,00	0,056	2,00	15,00	0,206	0,50	15,00
10	3°	0,032	10,00	10,00	0,054	2,00	20,00	0,185	0,50	20,00
10	3°	0,031	10,00	10,00	0,050	2,00	20,00	0,185	0,50	20,00
10	3°	0,039	10,00	10,00	0,060	2,00	15,00	0,206	0,50	15,00
10	3°	0,038	10,00	10,00	0,056	2,00	15,00	0,206	0,50	15,00
10	3°	0,032	10,00	10,00	0,054	2,00	20,00	0,185	0,50	20,00
10	3°	0,031	10,00	10,00	0,050	2,00	20,00	0,185	0,50	20,00
10	3°	0,039	10,00	10,00	0,060	2,00	15,00	0,206	0,50	15,00
10	3°	0,038	10,00	10,00	0,056	2,00	15,00	0,206	0,50	15,00
10	3°	0,032	10,00	10,00	0,054	2,00	20,00	0,185	0,50	20,00
10	3°	0,031	10,00	10,00	0,050	2,00	20,00	0,185	0,50	20,00

Abmessungen in mm  
Dimensions in mm

**B**

# Schaftfräser, Eckenradius

End Mil, corner radius



## DSRV

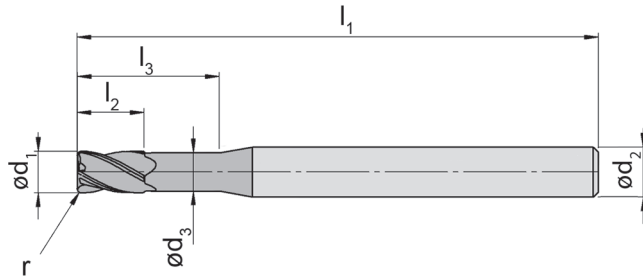
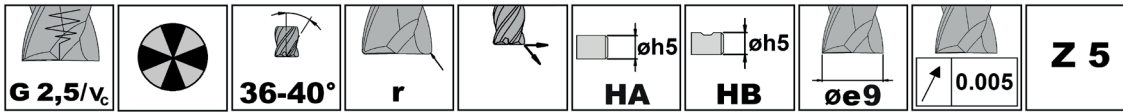

B

Bestellnummer Part number	d <sub>1</sub>	r	l <sub>2</sub>	l <sub>3</sub>	d <sub>3</sub>	d <sub>2</sub>	l <sub>1</sub>	Z	Form Form	TSTK
DSRV.5.120.020.20	12	0,2	18	24	11,4	12	73	5	HA	▲
DSRV.5.120.020.20B	12	0,2	18	24	11,4	12	73	5	HB	▲
DSRV.5.120.020.30	12	0,2	26	36	11,4	12	83	5	HA	▲
DSRV.5.120.020.30B	12	0,2	26	36	11,4	12	83	5	HB	▲
DSRV.5.120.050.20	12	0,5	18	24	11,4	12	73	5	HA	▲
DSRV.5.120.050.20B	12	0,5	18	24	11,4	12	73	5	HB	▲
DSRV.5.120.050.30	12	0,5	26	36	11,4	12	83	5	HA	▲
DSRV.5.120.050.30B	12	0,5	26	36	11,4	12	83	5	HB	▲
DSRV.5.120.100.20	12	1,0	18	24	11,4	12	73	5	HA	▲
DSRV.5.120.100.20B	12	1,0	18	24	11,4	12	73	5	HB	▲
DSRV.5.120.100.30	12	1,0	26	36	11,4	12	83	5	HA	▲
DSRV.5.120.100.30B	12	1,0	26	36	11,4	12	83	5	HB	▲
DSRV.5.120.150.20	12	1,5	18	24	11,4	12	73	5	HA	▲
DSRV.5.120.150.20B	12	1,5	18	24	11,4	12	73	5	HB	▲
DSRV.5.120.150.30	12	1,5	26	36	11,4	12	83	5	HA	▲
DSRV.5.120.150.30B	12	1,5	26	36	11,4	12	83	5	HB	▲
DSRV.5.120.200.20	12	2,0	18	24	11,4	12	73	5	HA	▲
DSRV.5.120.200.20B	12	2,0	18	24	11,4	12	73	5	HB	▲
DSRV.5.120.200.30	12	2,0	26	36	11,4	12	83	5	HA	▲
DSRV.5.120.200.30B	12	2,0	26	36	11,4	12	83	5	HB	▲
DSRV.5.120.250.20	12	2,5	18	24	11,4	12	73	5	HA	▲
DSRV.5.120.250.20B	12	2,5	18	24	11,4	12	73	5	HB	▲
DSRV.5.120.250.30	12	2,5	26	36	11,4	12	83	5	HA	▲
DSRV.5.120.250.30B	12	2,5	26	36	11,4	12	83	5	HB	▲
DSRV.5.120.300.20	12	3,0	18	24	11,4	12	73	5	HA	▲
DSRV.5.120.300.20B	12	3,0	18	24	11,4	12	73	5	HB	▲
DSRV.5.120.300.30	12	3,0	26	36	11,4	12	83	5	HA	▲
DSRV.5.120.300.30B	12	3,0	26	36	11,4	12	83	5	HB	▲

▲ ab Lager / on stock Δ 4 Wochen / 4 weeks x auf Anfrage / upon request

● empfohlen / recommended

o bedingt einsetzbar / alternative recommendation

- nicht geeignet / not suitable

■ unbeschichtete HM-Sorten / uncoated grades

■ beschichtete HM-Sorten / coated grades

■ bestückt/Cermet / brazed/Cermet

Abmessungen in mm

Dimensions in mm

P	•
M	•
K	•
N	-
S	•
H	-



HM-Sorten  
Carbide grades

# Schnittdaten DSRV Ø 12 mm

## Cutting Data DSRV Ø 12 mm

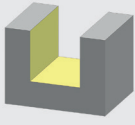
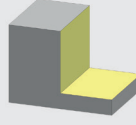
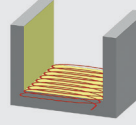

	 vc = m/min	 vc = m/min	 vc = m/min
<b>M1.1</b>	100	130	190
<b>M2.1</b>	80	100	150
<b>M3.1</b>	70	90	130
<b>S1.1</b>	60	80	120
<b>S2.1</b>	40	50	70
<b>S3.1</b>	33	40	60

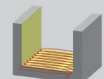
d <sub>1</sub>										
		f <sub>z</sub>	a <sub>e</sub>	a <sub>p</sub>	f <sub>z</sub>	a <sub>e</sub>	a <sub>p</sub>	f <sub>z</sub>	a <sub>e</sub>	a <sub>p</sub>
12	3°	0,047	12,00	12,00	0,073	2,40	18,00	0,248	0,60	18,00
12	3°	0,046	12,00	12,00	0,069	2,40	18,00	0,248	0,60	18,00
12	3°	0,038	12,00	12,00	0,066	2,40	24,00	0,223	0,60	24,00
12	3°	0,037	12,00	12,00	0,062	2,40	24,00	0,223	0,60	24,00
12	3°	0,047	12,00	12,00	0,073	2,40	18,00	0,248	0,60	18,00
12	3°	0,046	12,00	12,00	0,069	2,40	18,00	0,248	0,60	18,00
12	3°	0,038	12,00	12,00	0,066	2,40	24,00	0,223	0,60	24,00
12	3°	0,037	12,00	12,00	0,062	2,40	24,00	0,223	0,60	24,00
12	3°	0,047	12,00	12,00	0,073	2,40	18,00	0,248	0,60	18,00
12	3°	0,046	12,00	12,00	0,069	2,40	18,00	0,248	0,60	18,00
12	3°	0,038	12,00	12,00	0,066	2,40	24,00	0,223	0,60	24,00
12	3°	0,037	12,00	12,00	0,062	2,40	24,00	0,223	0,60	24,00
12	3°	0,047	12,00	12,00	0,073	2,40	18,00	0,248	0,60	18,00
12	3°	0,046	12,00	12,00	0,069	2,40	18,00	0,248	0,60	18,00
12	3°	0,038	12,00	12,00	0,066	2,40	24,00	0,223	0,60	24,00
12	3°	0,037	12,00	12,00	0,062	2,40	24,00	0,223	0,60	24,00
12	3°	0,047	12,00	12,00	0,073	2,40	18,00	0,248	0,60	18,00
12	3°	0,046	12,00	12,00	0,069	2,40	18,00	0,248	0,60	18,00
12	3°	0,038	12,00	12,00	0,066	2,40	24,00	0,223	0,60	24,00
12	3°	0,037	12,00	12,00	0,062	2,40	24,00	0,223	0,60	24,00
12	3°	0,047	12,00	12,00	0,073	2,40	18,00	0,248	0,60	18,00
12	3°	0,046	12,00	12,00	0,069	2,40	18,00	0,248	0,60	18,00
12	3°	0,038	12,00	12,00	0,066	2,40	24,00	0,223	0,60	24,00
12	3°	0,037	12,00	12,00	0,062	2,40	24,00	0,223	0,60	24,00
12	3°	0,047	12,00	12,00	0,073	2,40	18,00	0,248	0,60	18,00
12	3°	0,046	12,00	12,00	0,069	2,40	18,00	0,248	0,60	18,00
12	3°	0,038	12,00	12,00	0,066	2,40	24,00	0,223	0,60	24,00
12	3°	0,037	12,00	12,00	0,062	2,40	24,00	0,223	0,60	24,00

Abmessungen in mm  
Dimensions in mm

**B**

# Schaftfräser, Eckenradius

End Mil, corner radius



## DSRV

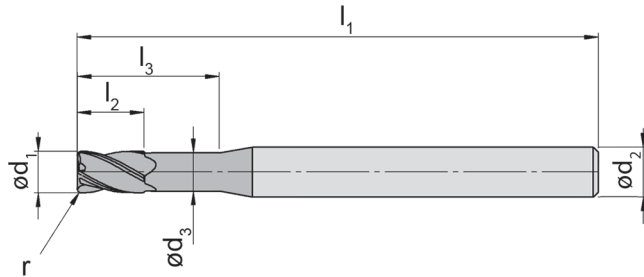
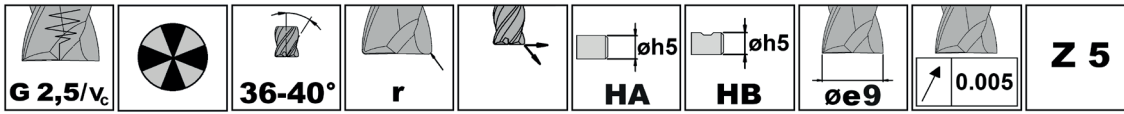

B

Bestellnummer Part number	d <sub>1</sub>	r	l <sub>2</sub>	l <sub>3</sub>	d <sub>3</sub>	d <sub>2</sub>	l <sub>1</sub>	Z	Form Form	TSTK
DSRV.5.160.020.20	16	0,2	24	32	15,2	16	82	5	HA	▲
DSRV.5.160.020.20B	16	0,2	24	32	15,2	16	82	5	HB	▲
DSRV.5.160.020.30	16	0,2	34	48	15,2	16	100	5	HA	▲
DSRV.5.160.020.30B	16	0,2	34	48	15,2	16	100	5	HB	▲
DSRV.5.160.050.20	16	0,5	24	32	15,2	16	82	5	HA	▲
DSRV.5.160.050.20B	16	0,5	24	32	15,2	16	82	5	HB	▲
DSRV.5.160.050.30	16	0,5	34	48	15,2	16	100	5	HA	▲
DSRV.5.160.050.30B	16	0,5	34	48	15,2	16	100	5	HB	▲
DSRV.5.160.100.20	16	1,0	24	32	15,2	16	82	5	HA	▲
DSRV.5.160.100.20B	16	1,0	24	32	15,2	16	82	5	HB	▲
DSRV.5.160.100.30	16	1,0	34	48	15,2	16	100	5	HA	▲
DSRV.5.160.100.30B	16	1,0	34	48	15,2	16	100	5	HB	▲
DSRV.5.160.150.20	16	1,5	24	32	15,2	16	82	5	HA	▲
DSRV.5.160.150.20B	16	1,5	24	32	15,2	16	82	5	HB	▲
DSRV.5.160.150.30	16	1,5	34	48	15,2	16	100	5	HA	▲
DSRV.5.160.150.30B	16	1,5	34	48	15,2	16	100	5	HB	▲
DSRV.5.160.200.20	16	2,0	24	32	15,2	16	82	5	HA	▲
DSRV.5.160.200.20B	16	2,0	24	32	15,2	16	82	5	HB	▲
DSRV.5.160.200.30B	16	2,0	34	48	15,2	16	100	5	HB	▲
DSRV.5.160.200.30	16	2,0	34	48	15,2	16	100	5	HA	▲
DSRV.5.160.250.20	16	2,5	24	32	15,2	16	82	5	HA	▲
DSRV.5.160.250.20B	16	2,5	24	32	15,2	16	82	5	HB	▲
DSRV.5.160.250.30	16	2,5	34	48	15,2	16	100	5	HA	▲
DSRV.5.160.250.30B	16	2,5	34	48	15,2	16	100	5	HB	▲
DSRV.5.160.300.20	16	3,0	24	32	15,2	16	82	5	HA	▲
DSRV.5.160.300.20B	16	3,0	24	32	15,2	16	82	5	HB	▲
DSRV.5.160.300.30	16	3,0	34	48	15,2	16	100	5	HA	▲
DSRV.5.160.300.30B	16	3,0	34	48	15,2	16	100	5	HB	▲
DSRV.5.160.400.20	16	4,0	24	32	15,2	16	82	5	HA	▲
DSRV.5.160.400.20B	16	4,0	24	32	15,2	16	82	5	HB	▲
DSRV.5.160.400.30	16	4,0	34	48	15,2	16	100	5	HA	▲
DSRV.5.160.400.30B	16	4,0	34	48	15,2	16	100	5	HB	▲

▲ ab Lager / on stock Δ 4 Wochen / 4 weeks x auf Anfrage / upon request

● empfohlen / recommended

o bedingt einsetzbar / alternative recommendation

- nicht geeignet / not suitable

■ unbeschichtete HM-Sorten / uncoated grades

■ beschichtete HM-Sorten / coated grades

■ bestückt/Cermet / brazed/Cermet

Abmessungen in mm

Dimensions in mm

P	•
M	•
K	◦
N	-
S	•
H	-





# Schaftfräser, Eckenradius

End Mill, corner radius



## DSRV

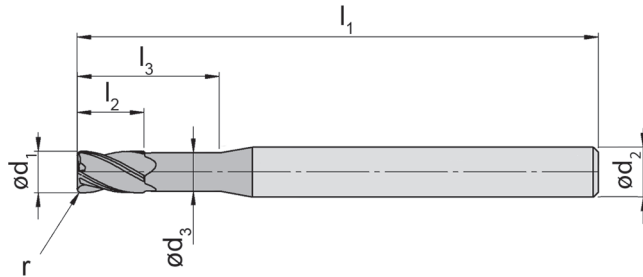
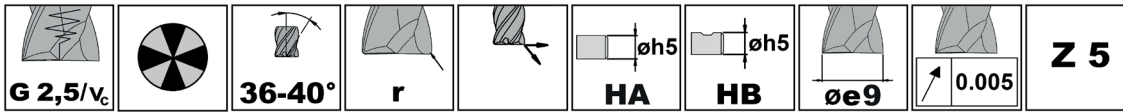

B

Bestellnummer Part number	d <sub>1</sub>	r	l <sub>2</sub>	l <sub>3</sub>	d <sub>3</sub>	d <sub>2</sub>	l <sub>1</sub>	Z	Form Form	TSTK
DSRV.5.200.020.20	20	0,2	30	40	19	20	92	5	HA	▲
DSRV.5.200.020.20B	20	0,2	30	40	19	20	92	5	HB	▲
DSRV.5.200.020.30	20	0,2	42	60	19	20	120	5	HA	▲
DSRV.5.200.020.30B	20	0,2	42	60	19	20	120	5	HB	▲
DSRV.5.200.050.20	20	0,5	30	40	19	20	92	5	HA	▲
DSRV.5.200.050.20B	20	0,5	30	40	19	20	92	5	HB	▲
DSRV.5.200.050.30	20	0,5	42	60	19	20	120	5	HA	▲
DSRV.5.200.050.30B	20	0,5	42	60	19	20	120	5	HB	▲
DSRV.5.200.100.20	20	1,0	30	40	19	20	92	5	HA	▲
DSRV.5.200.100.20B	20	1,0	30	40	19	20	92	5	HB	▲
DSRV.5.200.100.30	20	1,0	42	60	19	20	120	5	HA	▲
DSRV.5.200.100.30B	20	1,0	42	60	19	20	120	5	HB	▲
DSRV.5.200.150.20	20	1,5	30	40	19	20	92	5	HA	▲
DSRV.5.200.150.20B	20	1,5	30	40	19	20	92	5	HB	▲
DSRV.5.200.150.30	20	1,5	42	60	19	20	120	5	HA	▲
DSRV.5.200.150.30B	20	1,5	42	60	19	20	120	5	HB	▲
DSRV.5.200.200.20	20	2,0	30	40	19	20	92	5	HA	▲
DSRV.5.200.200.20B	20	2,0	30	40	19	20	92	5	HB	▲
DSRV.5.200.200.30	20	2,0	42	60	19	20	120	5	HA	▲
DSRV.5.200.200.30B	20	2,0	42	60	19	20	120	5	HB	▲
DSRV.5.200.250.20B	20	2,5	30	40	19	20	92	5	HB	▲
DSRV.5.200.250.20	20	2,5	30	40	19	20	92	5	HA	▲
DSRV.5.200.250.30	20	2,5	42	60	19	20	120	5	HA	▲
DSRV.5.200.250.30B	20	2,5	42	60	19	20	120	5	HB	▲
DSRV.5.200.300.20	20	3,0	30	40	19	20	92	5	HA	▲
DSRV.5.200.300.20B	20	3,0	30	40	19	20	92	5	HB	▲
DSRV.5.200.300.30	20	3,0	42	60	19	20	120	5	HA	▲
DSRV.5.200.300.30B	20	3,0	42	60	19	20	120	5	HB	▲
DSRV.5.200.400.20	20	4,0	30	40	19	20	92	5	HA	▲
DSRV.5.200.400.20B	20	4,0	30	40	19	20	92	5	HB	▲
DSRV.5.200.400.30	20	4,0	42	60	19	20	120	5	HA	▲
DSRV.5.200.400.30B	20	4,0	42	60	19	20	120	5	HB	▲

▲ ab Lager / on stock Δ 4 Wochen / 4 weeks x auf Anfrage / upon request

● empfohlen / recommended

o bedingt einsetzbar / alternative recommendation

- nicht geeignet / not suitable

■ unbeschichtete HM-Sorten / uncoated grades

■ beschichtete HM-Sorten / coated grades

■ bestückt/Cermet / brazed/Cermet

Abmessungen in mm

Dimensions in mm





P	•
M	•
K	◦
N	-
S	•
H	-

# Schnittdaten DSRV Ø 20 mm

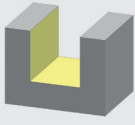
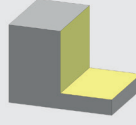
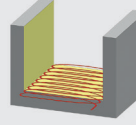
## Cutting Data DSRV Ø 20 mm



	 vc = m/min	 vc = m/min	 vc = m/min
<b>M1.1</b>	100	130	190
<b>M2.1</b>	80	100	150
<b>M3.1</b>	70	90	130
<b>S1.1</b>	60	80	120
<b>S2.1</b>	40	50	70
<b>S3.1</b>	33	40	60

d <sub>1</sub>	 α									
		f <sub>z</sub>	a <sub>e</sub>	a <sub>p</sub>	f <sub>z</sub>	a <sub>e</sub>	a <sub>p</sub>	f <sub>z</sub>	a <sub>e</sub>	a <sub>p</sub>
20	3°	0,079	20,00	20,00	0,124	4,00	30,00	0,419	1,00	30,00
20	3°	0,078	20,00	20,00	0,120	4,00	30,00	0,419	1,00	30,00
20	3°	0,064	20,00	20,00	0,112	4,00	40,00	0,377	1,00	40,00
20	3°	0,063	20,00	20,00	0,108	4,00	40,00	0,377	1,00	40,00
20	3°	0,079	20,00	20,00	0,124	4,00	30,00	0,419	1,00	30,00
20	3°	0,078	20,00	20,00	0,120	4,00	30,00	0,419	1,00	30,00
20	3°	0,064	20,00	20,00	0,112	4,00	40,00	0,377	1,00	40,00
20	3°	0,063	20,00	20,00	0,108	4,00	40,00	0,377	1,00	40,00
20	3°	0,079	20,00	20,00	0,124	4,00	30,00	0,419	1,00	30,00
20	3°	0,078	20,00	20,00	0,120	4,00	30,00	0,419	1,00	30,00
20	3°	0,064	20,00	20,00	0,112	4,00	40,00	0,377	1,00	40,00
20	3°	0,063	20,00	20,00	0,108	4,00	40,00	0,377	1,00	40,00
20	3°	0,079	20,00	20,00	0,124	4,00	30,00	0,419	1,00	30,00
20	3°	0,078	20,00	20,00	0,120	4,00	30,00	0,419	1,00	30,00
20	3°	0,064	20,00	20,00	0,112	4,00	40,00	0,377	1,00	40,00
20	3°	0,063	20,00	20,00	0,108	4,00	40,00	0,377	1,00	40,00
20	3°	0,079	20,00	20,00	0,124	4,00	30,00	0,419	1,00	30,00
20	3°	0,078	20,00	20,00	0,120	4,00	30,00	0,419	1,00	30,00
20	3°	0,064	20,00	20,00	0,112	4,00	40,00	0,377	1,00	40,00
20	3°	0,063	20,00	20,00	0,108	4,00	40,00	0,377	1,00	40,00
20	3°	0,079	20,00	20,00	0,124	4,00	30,00	0,419	1,00	30,00
20	3°	0,078	20,00	20,00	0,120	4,00	30,00	0,419	1,00	30,00
20	3°	0,064	20,00	20,00	0,112	4,00	40,00	0,377	1,00	40,00
20	3°	0,063	20,00	20,00	0,108	4,00	40,00	0,377	1,00	40,00
20	3°	0,079	20,00	20,00	0,124	4,00	30,00	0,419	1,00	30,00
20	3°	0,078	20,00	20,00	0,120	4,00	30,00	0,419	1,00	30,00
20	3°	0,064	20,00	20,00	0,112	4,00	40,00	0,377	1,00	40,00
20	3°	0,063	20,00	20,00	0,108	4,00	40,00	0,377	1,00	40,00
20	3°	0,079	20,00	20,00	0,124	4,00	30,00	0,419	1,00	30,00
20	3°	0,078	20,00	20,00	0,120	4,00	30,00	0,419	1,00	30,00
20	3°	0,064	20,00	20,00	0,112	4,00	40,00	0,377	1,00	40,00
20	3°	0,063	20,00	20,00	0,108	4,00	40,00	0,377	1,00	40,00



**B**

Abmessungen in mm  
Dimensions in mm

# Vollhartmetall-Schaftfräser

Solid Carbide End Mills



	DSKMA	Schaftfräser Vollradius Mikro Ball Nose End Mill Micro	Ø 0,1 – Ø 3	Z 2	B154 – B157
	DSMA	Schaftfräser Mikro, scharfkantig End Mill Micro, sharp	Ø 0,1 – Ø 3	Z 2	B158 – B161
	DSTMA	Torusfräser Mikro Torus End Mill Micro	Ø 0,1 – Ø 3	Z 2	B162 – B167
	DSA.1	Schaftfräser Einscheider End Mill single fluted	Ø 0,3 – Ø 20	Z 1	B168 – B171
	DSKA	Schaftfräser Vollradius Ball Nose End Mill	Ø 4 – Ø 20	Z 2	B172 – B173
	DSA.3	Schaftfräser, scharfkantig End Mill, sharp	Ø 4 – Ø 20	Z 3	B174 – B175
	DSRA.3	Schaftfräser, Eckradius End Mill, Corner Radius	Ø 4 – Ø 20	Z 3	B176 – B183
	DSFA.3	Schaftfräser HPC, Eckfase End Mill HPC, chamfer	Ø 6 – Ø 20	Z 3	B184 – B185
	DSFRA.3	Kordelschruppfräser Roughing End Mill with ripper profile	Ø 6 – Ø 20	Z 3	B186 – B187

B

**DS**



**B**

**abgestimmt für:**

- Aluminium
- Kunststoff

**designed for:**

- Aluminium
- Synthetics

# Schaftfräser Vollradius Mikro

## Ball Nose End Mill Micro



### DSKMA

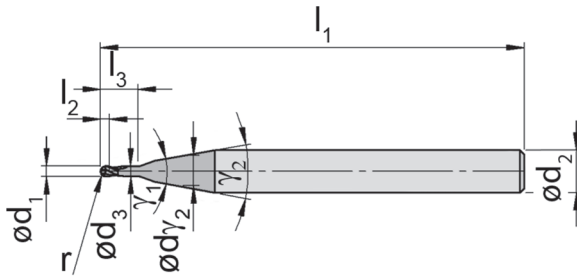

Bis Ø 3 mm vormontiert lieferbar für Toodle Schnelllaufspindel (siehe Seite D2)  
Pre-assembled available up to Ø 3 mm for Toodle high-speed spindle (see page D2)

B

Bestellnummer Part number	d <sub>1</sub>	r	l <sub>2</sub>	l <sub>3</sub>	d <sub>3</sub>	d <sub>2</sub>	l <sub>1</sub>	Z	γ <sub>1</sub>	γ <sub>2</sub>	d <sub>v2</sub>	MG3K
DSKMA.010.030	0,1	0,05	0,25	0,3	0,084	4	50	2	20°	-°	0	▲
DSKMA.010.050	0,1	0,05	0,25	0,5	0,084	4	50	2	40°	20°	2	▲
DSKMA.010.070	0,1	0,05	0,25	0,7	0,084	4	50	2	40°	20°	2	▲
DSKMA.020.030	0,2	0,10	0,50	0,6	0,180	4	50	2	20°	-°	0	▲
DSKMA.020.050	0,2	0,10	0,50	1,0	0,180	4	50	2	40°	20°	2	▲
DSKMA.020.070	0,2	0,10	0,50	1,4	0,180	4	50	2	40°	20°	2	▲
DSKMA.030.030	0,3	0,15	0,75	0,9	0,280	4	50	2	20°	-°	0	▲
DSKMA.030.050	0,3	0,15	0,75	1,5	0,280	4	50	2	40°	20°	2	▲
DSKMA.030.070	0,3	0,15	0,75	2,1	0,280	4	50	2	40°	20°	2	▲
DSKMA.050.030	0,5	0,25	1,25	1,5	0,470	4	50	2	20°	-°	0	▲
DSKMA.050.050	0,5	0,25	1,25	2,5	0,470	4	50	2	40°	20°	2	▲
DSKMA.050.070	0,5	0,25	1,25	3,5	0,470	4	50	2	40°	20°	2	▲
DSKMA.060.030	0,6	0,30	1,50	1,8	0,560	4	50	2	20°	-°	0	▲
DSKMA.060.050	0,6	0,30	1,50	3,0	0,560	4	50	2	40°	20°	2	▲
DSKMA.060.070	0,6	0,30	1,50	4,2	0,560	4	50	2	40°	20°	2	▲
DSKMA.080.030	0,8	0,40	2,00	2,4	0,750	4	50	2	20°	-°	0	▲
DSKMA.080.050	0,8	0,40	2,00	4,0	0,750	4	50	2	40°	20°	2	▲
DSKMA.080.070	0,8	0,40	2,00	5,6	0,750	4	50	2	40°	20°	2	▲

▲ ab Lager / on stock Δ 4 Wochen / 4 weeks x auf Anfrage / upon request

● empfohlen / recommended

o bedingt einsetzbar / alternative recommendation

- nicht geeignet / not suitable

■ unbeschichtete HM-Sorten / uncoated grades

■ beschichtete HM-Sorten / coated grades

■ bestückt/Cermet / brazed/Cermet

Abmessungen in mm

Dimensions in mm

P	-
M	-
K	-
N	•
S	-
H	-



HM-Sorten  
Carbide grades

# Schnittdaten DSKMA Ø 0,1 - 0,8 mm

## Cutting Data DSKMA Ø 0,1 - 0,8 mm

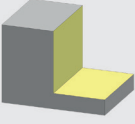
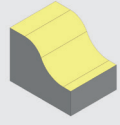

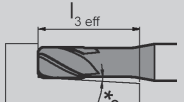
	 $vc = m/min$	 $vc = m/min$
N1.1	460	550
N1.2	480	580
N2.1	460	550
N2.2	390	470
N2.3	260	310
N3.1	330	400
N3.2	290	350
N4.1	330	400

$d_1$	 $\alpha$	 $l_{3\text{eff}}$										
		0°	0,5°	1°	2°	3°	$f_z$	$a_e$	$a_p$	$f_z$	$a_e$	$a_p$
0,1	7°	0,3	0,3	0,3	0,3	0,4	0,005	0,03	0,10	0,006	0,01	0,01
0,1	5°	0,5	0,5	0,5	0,5	0,5	0,004	0,03	0,10	0,005	0,01	0,01
0,1	3°	0,7	0,7	0,7	0,7	0,8	0,004	0,03	0,10	0,005	0,01	0,01
0,2	7°	0,6	0,6	0,6	0,7	0,8	0,006	0,06	0,20	0,007	0,01	0,02
0,2	5°	1,0	1,0	1,0	1,1	1,1	0,005	0,06	0,20	0,006	0,01	0,02
0,2	3°	1,4	1,4	1,4	1,5	1,6	0,004	0,06	0,20	0,006	0,01	0,01
0,3	7°	0,9	0,9	0,9	1,0	1,2	0,007	0,09	0,30	0,009	0,02	0,03
0,3	5°	1,5	1,5	1,5	1,6	1,7	0,006	0,09	0,30	0,008	0,02	0,02
0,3	3°	2,1	2,1	2,2	2,3	2,4	0,005	0,09	0,30	0,007	0,02	0,02
0,5	7°	1,5	1,5	1,6	1,8	2,0	0,009	0,15	0,50	0,012	0,03	0,05
0,5	5°	2,5	2,5	2,6	2,7	2,8	0,008	0,15	0,50	0,011	0,03	0,04
0,5	3°	3,5	3,5	3,6	3,8	4,0	0,007	0,15	0,50	0,009	0,03	0,03
0,6	7°	1,8	1,8	1,9	2,1	2,4	0,010	0,18	0,60	0,013	0,03	0,06
0,6	5°	3,0	3,0	3,1	3,2	3,4	0,009	0,18	0,60	0,012	0,03	0,05
0,6	3°	4,2	4,3	4,4	4,6	4,8	0,008	0,18	0,60	0,011	0,03	0,04
0,8	7°	2,4	2,5	2,6	2,9	3,2	0,012	0,24	0,80	0,016	0,04	0,08
0,8	5°	4,0	4,0	4,1	4,3	4,6	0,010	0,24	0,80	0,015	0,04	0,06
0,8	3°	5,6	5,7	5,8	6,1	6,4	0,009	0,24	0,80	0,013	0,04	0,05

Abmessungen in mm  
Dimensions in mm



# Schaftfräser Vollradius Mikro

## Ball Nose End Mill Micro



### DSKMA

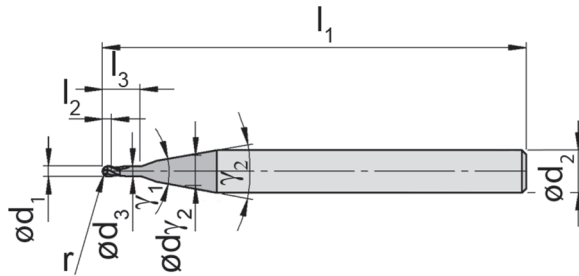

Bis Ø 3 mm vormontiert lieferbar für Toodle Schnelllaufspindel (siehe Seite D2)  
 Pre-assembled available up to Ø 3 mm for Toodle high-speed spindle (see page D2)

B

Bestellnummer Part number	d <sub>1</sub>	r	l <sub>2</sub>	l <sub>3</sub>	d <sub>3</sub>	d <sub>2</sub>	l <sub>1</sub>	Z	γ <sub>1</sub>	γ <sub>2</sub>	d <sub>v2</sub>	MG3K
DSKMA.100.030	1,0	0,50	2,50	3,0	0,95	4	50	2	20°	-°	0	▲
DSKMA.100.050	1,0	0,50	2,50	5,0	0,95	4	50	2	40°	20°	2,0	▲
DSKMA.100.070	1,0	0,50	2,50	7,0	0,95	4	50	2	40°	20°	2,0	▲
DSKMA.120.030	1,2	0,60	3,00	3,6	1,15	4	50	2	20°	-°	0	▲
DSKMA.120.050	1,2	0,60	3,00	6,0	1,15	4	50	2	40°	20°	2,0	▲
DSKMA.120.070	1,2	0,60	3,00	8,4	1,15	4	50	2	40°	20°	2,0	▲
DSKMA.150.030	1,5	0,75	3,75	4,5	1,45	4	50	2	20°	-°	0	▲
DSKMA.150.050	1,5	0,75	3,75	7,5	1,45	4	50	2	40°	20°	2,5	▲
DSKMA.150.070	1,5	0,75	3,75	10,5	1,45	4	50	2	40°	20°	2,5	▲
DSKMA.200.030	2,0	1,00	5,00	6,0	1,90	4	50	2	20°	-°	0	▲
DSKMA.200.050	2,0	1,00	5,00	10,0	1,90	4	50	2	40°	20°	3,0	▲
DSKMA.200.070	2,0	1,00	5,00	14,0	1,90	4	50	2	40°	20°	3,0	▲
DSKMA.250.030	2,5	1,25	6,25	7,5	2,40	4	50	2	20°	-°	0	▲
DSKMA.250.050	2,5	1,25	6,25	12,5	2,40	4	50	2	40°	20°	3,5	▲
DSKMA.250.070	2,5	1,25	6,25	17,5	2,40	4	50	2	40°	20°	3,5	▲
DSKMA.300.030	3,0	1,50	7,50	9,0	2,90	4	50	2	20°	-°	0	▲
DSKMA.300.050	3,0	1,50	7,50	15,0	2,90	4	50	2	40°	20°	3,5	▲
DSKMA.300.070	3,0	1,50	7,50	21,0	2,90	4	64	2	40°	20°	3,5	▲

▲ ab Lager / on stock Δ 4 Wochen / 4 weeks x auf Anfrage / upon request

● empfohlen / recommended

o bedingt einsetzbar / alternative recommendation

- nicht geeignet / not suitable

■ unbeschichtete HM-Sorten / uncoated grades

■ beschichtete HM-Sorten / coated grades

■ bestückt/Cermet / brazed/Cermet

Abmessungen in mm

Dimensions in mm

P	-
M	-
K	-
N	•
S	-
H	-



HM-Sorten  
Carbide grades

# Schnittdaten DSKMA Ø 1 - 3 mm

## Cutting Data DSKMA Ø 1 - 3 mm

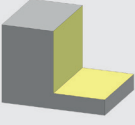
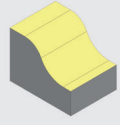

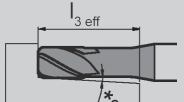
	 vc = m/min	 vc = m/min
N1.1	460	550
N1.2	480	580
N2.1	460	550
N2.2	390	470
N2.3	260	310
N3.1	330	400
N3.2	290	350
N4.1	330	400

d <sub>1</sub>	 α	 l <sub>3 eff</sub>										
		0°	0,5°	1°	2°	3°	f <sub>z</sub>	a <sub>e</sub>	a <sub>p</sub>	f <sub>z</sub>	a <sub>e</sub>	a <sub>p</sub>
1,0	7°	3,0	3,1	3,2	3,6	4,0	0,014	0,30	1,00	0,019	0,05	0,10
1,0	5°	5,0	5,1	5,2	5,4	5,7	0,012	0,30	1,00	0,017	0,05	0,08
1,0	3°	7,0	7,1	7,3	7,6	8,1	0,011	0,30	1,00	0,015	0,05	0,06
1,2	7°	3,6	3,7	3,9	4,3	4,8	0,016	0,36	1,20	0,022	0,06	0,12
1,2	5°	6,0	6,1	6,2	6,5	6,9	0,014	0,36	1,20	0,020	0,06	0,10
1,2	3°	8,4	8,5	8,7	9,2	9,8	0,013	0,36	1,20	0,018	0,06	0,07
1,5	7°	4,5	4,7	4,9	5,4	6,1	0,019	0,45	1,50	0,027	0,08	0,15
1,5	5°	7,5	7,6	7,8	8,2	8,6	0,017	0,45	1,50	0,024	0,08	0,12
1,5	3°	10,5	10,7	10,9	11,5	12,3	0,015	0,45	1,50	0,021	0,08	0,09
2,0	7°	6,0	6,2	6,5	7,2	8,1	0,024	0,60	2,00	0,034	0,10	0,20
2,0	5°	10,0	10,2	10,4	10,9	11,5	0,021	0,60	2,00	0,031	0,10	0,16
2,0	3°	14,0	14,3	14,6	15,3	17,2	0,019	0,60	2,00	0,027	0,10	0,12
2,5	7°	7,5	7,8	8,1	9,0	10,1	0,029	0,75	2,50	0,041	0,13	0,25
2,5	5°	12,5	12,7	13,0	13,7	∞	0,026	0,75	2,50	0,037	0,13	0,20
2,5	3°	17,5	17,9	18,3	19,5	∞	0,023	0,75	2,50	0,033	0,13	0,15
3,0	7°	9,0	9,3	9,8	10,8	∞	0,034	0,90	3,00	0,049	0,15	0,30
3,0	5°	15,0	15,3	15,6	∞	∞	0,031	0,90	3,00	0,044	0,15	0,24
3,0	3°	21,0	21,4	22,1	∞	∞	0,027	0,90	3,00	0,039	0,15	0,18

Abmessungen in mm  
Dimensions in mm





# Schaftfräser Mikro, scharfkantig

## End Mill Micro, sharp



### DSMA

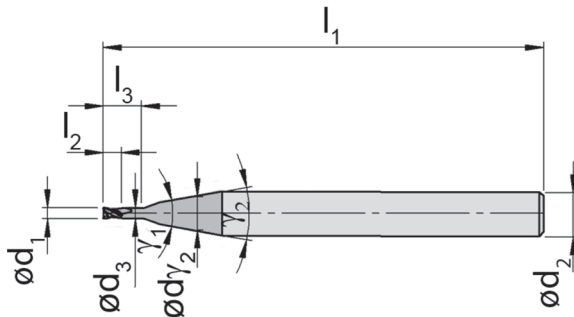
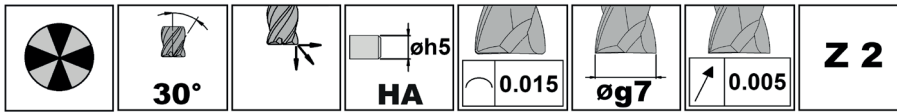

Bis Ø 3 mm vormontiert lieferbar für Toodle Schnelllaufspindel (siehe Seite D2)  
Pre-assembled available up to Ø 3 mm for Toodle high-speed spindle (see page D2)

B

Bestellnummer Part number	d <sub>1</sub>	l <sub>2</sub>	l <sub>3</sub>	d <sub>3</sub>	d <sub>2</sub>	l <sub>1</sub>	Z	γ <sub>1</sub>	γ <sub>2</sub>	d <sub>v2</sub>	MG3K
DSMA.010.030	0,1	0,25	0,3	0,084	4	50	2	20°	-°	0	▲
DSMA.010.050	0,1	0,25	0,5	0,084	4	50	2	40°	20°	2	▲
DSMA.010.070	0,1	0,25	0,7	0,084	4	50	2	40°	20°	2	▲
DSMA.020.030	0,2	0,50	0,6	0,180	4	50	2	20°	-°	0	▲
DSMA.020.050	0,2	0,50	1,0	0,180	4	50	2	40°	20°	2	▲
DSMA.020.070	0,2	0,50	1,4	0,180	4	50	2	40°	20°	2	▲
DSMA.030.030	0,3	0,75	0,9	0,280	4	50	2	20°	-°	0	▲
DSMA.030.050	0,3	0,75	1,5	0,280	4	50	2	40°	20°	2	▲
DSMA.030.070	0,3	0,75	2,1	0,280	4	50	2	40°	20°	2	▲
DSMA.050.030	0,5	1,25	1,5	0,470	4	50	2	20°	-°	0	▲
DSMA.050.050	0,5	1,25	2,5	0,470	4	50	2	40°	20°	2	▲
DSMA.050.070	0,5	1,25	3,5	0,470	4	50	2	40°	20°	2	▲
DSMA.060.030	0,6	1,50	1,8	0,560	4	50	2	20°	-°	0	▲
DSMA.060.050	0,6	1,50	3,0	0,560	4	50	2	40°	20°	2	▲
DSMA.060.070	0,6	1,50	4,2	0,560	4	50	2	40°	20°	2	▲
DSMA.080.030	0,8	2,00	2,4	0,750	4	50	2	20°	-°	0	▲
DSMA.080.050	0,8	2,00	4,0	0,750	4	50	2	40°	20°	2	▲
DSMA.080.070	0,8	2,00	5,6	0,750	4	50	2	40°	20°	2	▲
DSMA.100.030	1,0	2,50	3,0	0,950	4	50	2	20°	-°	0	▲
DSMA.100.050	1,0	2,50	5,0	0,950	4	50	2	40°	20°	2	▲
DSMA.100.070	1,0	2,50	7,0	0,950	4	50	2	40°	20°	2	▲

▲ ab Lager / on stock Δ 4 Wochen / 4 weeks x auf Anfrage / upon request

● empfohlen / recommended

o bedingt einsetzbar / alternative recommendation

- nicht geeignet / not suitable

■ unbeschichtete HM-Sorten / uncoated grades

■ beschichtete HM-Sorten / coated grades

■ bestückt/Cermet / brazed/Cermet

Abmessungen in mm

Dimensions in mm

P	-
M	-
K	-
N	•
S	-
H	-



HM-Sorten  
Carbide grades

# Schnittdaten DSMA Ø 0,1 - 1 mm

## Cutting Data DSMA Ø 0,1 - 1 mm

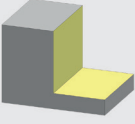
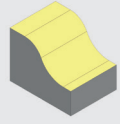

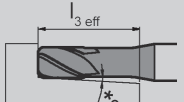
	 $vc = m/min$	 $vc = m/min$
N1.1	460	550
N1.2	480	580
N2.1	460	550
N2.2	390	470
N2.3	260	310
N3.1	330	400
N3.2	290	350
N4.1	330	400

$d_1$	 $\alpha$	 $l_{3\text{eff}}$										
		0°	0,5°	1°	2°	3°	$f_z$	$a_e$	$a_p$	$f_z$	$a_e$	$a_p$
0,1	7°	0,3	0,3	0,3	0,3	0,4	0,005	0,03	0,10	0,006	0,01	0,01
0,1	5°	0,5	0,5	0,5	0,5	0,5	0,004	0,03	0,10	0,005	0,01	0,01
0,1	3°	0,7	0,7	0,7	0,7	0,8	0,004	0,03	0,10	0,005	0,01	0,01
0,2	7°	0,6	0,6	0,6	0,7	0,8	0,006	0,06	0,20	0,007	0,01	0,02
0,2	5°	1,0	1,0	1,0	1,1	1,1	0,005	0,06	0,20	0,006	0,01	0,02
0,2	3°	1,4	1,4	1,4	1,5	1,6	0,004	0,06	0,20	0,006	0,01	0,01
0,3	7°	0,9	0,9	1,0	1,2	1,2	0,007	0,09	0,30	0,009	0,02	0,03
0,3	5°	1,5	1,5	1,5	1,6	1,7	0,006	0,09	0,30	0,008	0,02	0,02
0,3	3°	2,1	2,1	2,2	2,3	2,4	0,005	0,09	0,30	0,007	0,02	0,02
0,5	7°	1,5	1,5	1,6	1,8	2,1	0,009	0,15	0,50	0,012	0,03	0,05
0,5	5°	2,5	2,5	2,6	2,7	2,9	0,008	0,15	0,50	0,011	0,03	0,04
0,5	3°	3,5	3,5	3,6	3,8	4,0	0,007	0,15	0,50	0,009	0,03	0,03
0,6	7°	1,8	1,8	2,0	2,2	2,5	0,010	0,18	0,60	0,013	0,03	0,06
0,6	5°	3,0	3,0	3,1	3,3	3,5	0,009	0,18	0,60	0,012	0,03	0,05
0,6	3°	4,2	4,3	4,4	4,6	4,9	0,008	0,18	0,60	0,011	0,03	0,04
0,8	7°	2,4	2,5	2,6	2,9	3,4	0,012	0,24	0,80	0,016	0,04	0,08
0,8	5°	4,0	4,1	4,2	4,4	4,6	0,010	0,24	0,80	0,015	0,04	0,06
0,8	3°	5,6	5,7	5,8	6,1	6,5	0,009	0,24	0,80	0,013	0,04	0,05
1,0	7°	3,0	3,1	3,3	3,7	4,2	0,014	0,30	1,00	0,019	0,05	0,10
1,0	5°	5,0	5,1	5,2	5,5	5,8	0,012	0,30	1,00	0,017	0,05	0,08
1,0	3°	7,0	7,1	7,3	7,7	8,1	0,011	0,30	1,00	0,015	0,05	0,06

Abmessungen in mm  
Dimensions in mm



# Schaftfräser Mikro, scharfkantig

## End Mill Micro, sharp



### DSMA

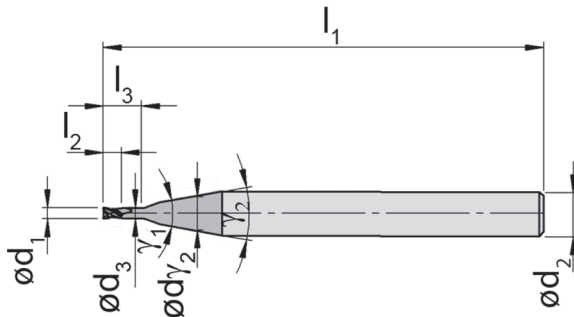
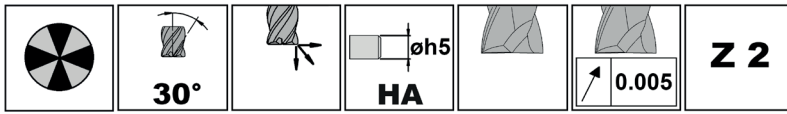

Bis Ø 3 mm vormontiert lieferbar für Toodle Schnelllaufspindel (siehe Seite D2)  
Pre-assembled available up to Ø 3 mm for Toodle high-speed spindle (see page D2)

B

Bestellnummer Part number	d <sub>1</sub>	l <sub>2</sub>	l <sub>3</sub>	d <sub>3</sub>	d <sub>2</sub>	l <sub>1</sub>	Z	γ <sub>1</sub>	γ <sub>2</sub>	d <sub>v2</sub>	MG3K
DSMA.120.030	1,2	3,00	3,6	1,15	4	50	2	20°	-°	0	▲
DSMA.120.050	1,2	3,00	6,0	1,15	4	50	2	40°	20°	2,0	▲
DSMA.120.070	1,2	3,00	8,4	1,15	4	50	2	40°	20°	2,0	▲
DSMA.150.030	1,5	3,75	4,5	1,45	4	50	2	20°	-°	0	▲
DSMA.150.050	1,5	3,75	7,5	1,45	4	50	2	40°	20°	2,5	▲
DSMA.150.070	1,5	3,75	10,5	1,45	4	50	2	40°	20°	2,5	▲
DSMA.200.030	2,0	5,00	6,0	1,90	4	50	2	20°	-°	0	▲
DSMA.200.050	2,0	5,00	10,0	1,90	4	50	2	40°	20°	3,0	▲
DSMA.200.070	2,0	5,00	14,0	1,90	4	50	2	40°	20°	3,0	▲
DSMA.250.030	2,5	6,25	7,5	2,40	4	50	2	20°	-°	0	▲
DSMA.250.050	2,5	6,25	12,5	2,40	4	50	2	40°	20°	3,5	▲
DSMA.250.070	2,5	6,25	17,5	2,40	4	50	2	40°	20°	3,5	▲
DSMA.300.030	3,0	7,50	9,0	2,90	4	50	2	20°	-°	0	▲
DSMA.300.050	3,0	7,50	15,0	2,90	4	50	2	40°	20°	3,5	▲
DSMA.300.070	3,0	7,50	21,0	2,90	4	64	2	40°	20°	3,5	▲

▲ ab Lager / on stock Δ 4 Wochen / 4 weeks x auf Anfrage / upon request

● empfohlen / recommended

o bedingt einsetzbar / alternative recommendation

- nicht geeignet / not suitable

■ unbeschichtete HM-Sorten / uncoated grades

■ beschichtete HM-Sorten / coated grades

■ bestückt/Cermet / brazed/Cermet

Abmessungen in mm

Dimensions in mm

P	-
M	-
K	-
N	•
S	-
H	-



HM-Sorten  
Carbide grades

# Schnittdaten DSMA Ø 1,2 - 3 mm

## Cutting Data DSMA Ø 1,2 - 3 mm

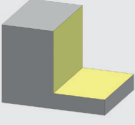
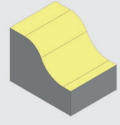

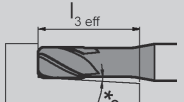
	 <b>vc = m/min</b>	 <b>vc = m/min</b>
<b>N1.1</b>	460	550
<b>N1.2</b>	480	580
<b>N2.1</b>	460	550
<b>N2.2</b>	390	470
<b>N2.3</b>	260	310
<b>N3.1</b>	330	400
<b>N3.2</b>	290	350
<b>N4.1</b>	330	400

d <sub>1</sub>	 α	 l <sub>3 eff</sub>										
		0°	0,5°	1°	2°	3°	f <sub>z</sub>	a <sub>e</sub>	a <sub>p</sub>	f <sub>z</sub>	a <sub>e</sub>	a <sub>p</sub>
1,2	7°	3,6	3,7	3,9	4,4	5,1	0,016	0,36	1,20	0,022	0,06	0,12
1,2	5°	6,0	6,1	6,3	6,6	7,0	0,014	0,36	1,20	0,020	0,06	0,10
1,2	3°	8,4	8,6	8,8	9,2	10,0	0,013	0,36	1,20	0,018	0,06	0,07
1,5	7°	4,5	4,7	4,9	5,6	6,4	0,019	0,45	1,50	0,027	0,08	0,15
1,5	5°	7,5	7,6	7,8	8,2	8,7	0,017	0,45	1,50	0,024	0,08	0,12
1,5	3°	10,5	10,7	11,0	11,6	12,6	0,015	0,45	1,50	0,021	0,08	0,09
2,0	7°	6,0	6,3	6,6	7,4	8,5	0,024	0,60	2,00	0,034	0,10	0,20
2,0	5°	10,0	10,2	10,5	11,0	11,9	0,021	0,60	2,00	0,031	0,10	0,16
2,0	3°	14,0	14,3	14,7	15,4	17,6	0,019	0,60	2,00	0,027	0,10	0,12
2,5	7°	7,5	7,8	8,3	9,3	10,6	0,029	0,75	2,50	0,041	0,13	0,25
2,5	5°	12,5	12,8	13,1	13,8	∞	0,026	0,75	2,50	0,037	0,13	0,20
2,5	3°	17,5	17,9	18,3	19,8	∞	0,023	0,75	2,50	0,033	0,13	0,15
3,0	7°	9,0	9,4	9,9	11,2	∞	0,034	0,90	3,00	0,049	0,15	0,30
3,0	5°	15,0	15,3	15,7	∞	∞	0,031	0,90	3,00	0,044	0,15	0,24
3,0	3°	21,0	21,5	22,0	∞	∞	0,027	0,90	3,00	0,039	0,15	0,18

Abmessungen in mm  
Dimensions in mm



### DSTMA

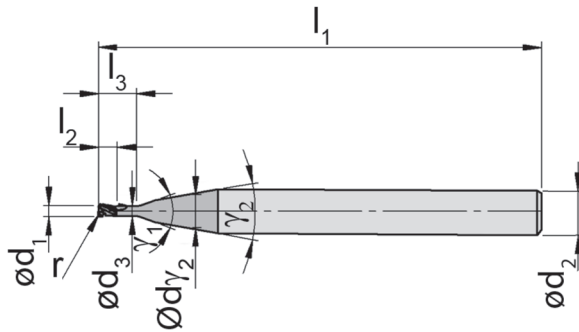
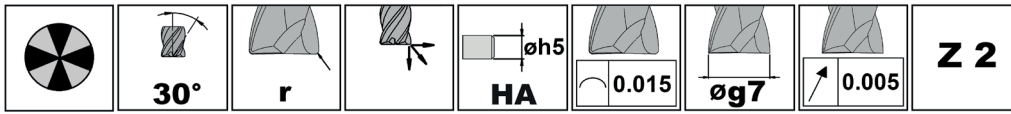

Bis Ø 3 mm vormontiert lieferbar für Toodle Schnellaufspindel (siehe Seite D2)  
Pre-assembled available up to Ø 3 mm for Toodle high-speed spindle (see page D2)

B

Bestellnummer Part number	d <sub>1</sub>	r	l <sub>2</sub>	l <sub>3</sub>	d <sub>3</sub>	d <sub>2</sub>	l <sub>1</sub>	Z	γ <sub>1</sub>	γ <sub>2</sub>	d <sub>v2</sub>	MG3K
DSTMA.010.003.030	0,1	0,03	0,25	0,3	0,084	4	50	2	20°	-°	0	▲
DSTMA.010.003.050	0,1	0,03	0,25	0,5	0,084	4	50	2	40°	20°	2	▲
DSTMA.010.003.070	0,1	0,03	0,25	0,7	0,084	4	50	2	40°	20°	2	▲
DSTMA.020.005.030	0,2	0,05	0,50	0,6	0,180	4	50	2	20°	-°	0	▲
DSTMA.020.005.050	0,2	0,05	0,50	1,0	0,180	4	50	2	40°	20°	2	▲
DSTMA.020.005.070	0,2	0,05	0,50	1,4	0,180	4	50	2	40°	20°	2	▲
DSTMA.030.005.030	0,3	0,05	0,75	0,9	0,280	4	50	2	20°	-°	0	▲
DSTMA.030.005.050	0,3	0,05	0,75	1,5	0,280	4	50	2	40°	20°	2	▲
DSTMA.030.005.070	0,3	0,05	0,75	2,1	0,280	4	50	2	40°	20°	2	▲
DSTMA.050.005.030	0,5	0,05	1,25	1,5	0,470	4	50	2	20°	-°	0	▲
DSTMA.050.005.050	0,5	0,05	1,25	2,5	0,470	4	50	2	40°	20°	2	▲
DSTMA.050.005.070	0,5	0,05	1,25	3,5	0,470	4	50	2	40°	20°	2	▲
DSTMA.050.010.030	0,5	0,10	1,25	1,5	0,470	4	50	2	20°	-°	0	▲
DSTMA.050.010.050	0,5	0,10	1,25	2,5	0,470	4	50	2	40°	20°	2	▲
DSTMA.050.010.070	0,5	0,10	1,25	3,5	0,470	4	50	2	40°	20°	2	▲
DSTMA.060.005.030	0,6	0,05	1,50	1,8	0,560	4	50	2	20°	-°	0	▲
DSTMA.060.005.050	0,6	0,05	1,50	3,0	0,560	4	50	2	40°	20°	2	▲
DSTMA.060.005.070	0,6	0,05	1,50	4,2	0,560	4	50	2	40°	20°	2	▲
DSTMA.060.010.030	0,6	0,10	1,50	1,8	0,560	4	50	2	20°	-°	0	▲
DSTMA.060.010.050	0,6	0,10	1,50	3,0	0,560	4	50	2	40°	20°	2	▲
DSTMA.060.010.070	0,6	0,10	1,50	4,2	0,560	4	50	2	40°	20°	2	▲
DSTMA.080.005.030	0,8	0,05	2,00	2,4	0,750	4	50	2	20°	-°	0	▲
DSTMA.080.005.050	0,8	0,05	2,00	4,0	0,750	4	50	2	40°	20°	2	▲
DSTMA.080.005.070	0,8	0,05	2,00	5,6	0,750	4	50	2	40°	20°	2	▲
DSTMA.080.010.030	0,8	0,10	2,00	2,4	0,750	4	50	2	20°	-°	0	▲
DSTMA.080.010.050	0,8	0,10	2,00	4,0	0,750	4	50	2	40°	20°	2	▲
DSTMA.080.010.070	0,8	0,10	2,00	5,6	0,750	4	50	2	40°	20°	2	▲

▲ ab Lager / on stock Δ 4 Wochen / 4 weeks x auf Anfrage / upon request

● empfohlen / recommended

o bedingt einsetzbar / alternative recommendation

- nicht geeignet / not suitable

■ unbeschichtete HM-Sorten / uncoated grades

■ beschichtete HM-Sorten / coated grades

■ bestückt/Cermet / brazed/Cermet

Abmessungen in mm

Dimensions in mm



P	-
M	-
K	-
N	•
S	-
H	-



HM-Sorten  
Carbide grades

# Schnittdaten DSTMA Ø 0,1 - 0,8 mm

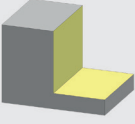
## Cutting Data DSTMA Ø 0,1 - 0,8 mm

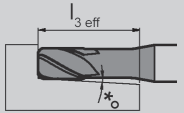

	 vc = m/min	 vc = m/min
N1.1	460	550
N1.2	480	580
N2.1	460	550
N2.2	390	470
N2.3	260	310
N3.1	330	400
N3.2	290	350
N4.1	330	400

d <sub>1</sub>												
		0°	0,5°	1°	2°	3°	f <sub>z</sub>	a <sub>e</sub>	a <sub>p</sub>	f <sub>z</sub>	a <sub>e</sub>	a <sub>p</sub>
0,1	7°	0,3	0,3	0,3	0,3	0,4	0,005	0,03	0,10	0,006	0,01	0,01
0,1	5°	0,5	0,5	0,5	0,5	0,5	0,004	0,03	0,10	0,005	0,01	0,01
0,1	3°	0,7	0,7	0,7	0,8	0,9	0,004	0,03	0,10	0,005	0,01	0,01
0,2	7°	0,6	0,6	0,6	0,7	0,8	0,006	0,06	0,20	0,007	0,01	0,02
0,2	5°	1,0	1,0	1,0	1,1	1,1	0,005	0,06	0,20	0,006	0,01	0,02
0,2	3°	1,4	1,4	1,4	1,5	1,6	0,004	0,06	0,20	0,006	0,01	0,01
0,3	7°	0,9	0,9	0,9	1,1	1,2	0,007	0,09	0,30	0,009	0,02	0,03
0,3	5°	1,5	1,5	1,5	1,6	1,7	0,006	0,09	0,30	0,008	0,02	0,02
0,3	3°	2,1	2,1	2,2	2,3	2,4	0,005	0,09	0,30	0,007	0,02	0,02
0,5	7°	1,5	1,5	1,6	1,8	2,1	0,009	0,15	0,50	0,012	0,03	0,05
0,5	5°	2,5	2,5	2,6	2,7	2,9	0,008	0,15	0,50	0,011	0,03	0,04
0,5	3°	3,5	3,5	3,6	3,8	4,0	0,007	0,15	0,50	0,009	0,03	0,03
0,5	7°	1,5	1,5	1,6	1,8	2,0	0,009	0,15	0,50	0,012	0,03	0,05
0,5	5°	2,5	2,5	2,6	2,7	2,9	0,008	0,15	0,50	0,011	0,03	0,04
0,5	3°	3,5	3,5	3,6	3,8	4,0	0,007	0,15	0,50	0,009	0,03	0,03
0,6	7°	1,8	1,8	1,9	2,2	2,5	0,010	0,18	0,60	0,013	0,03	0,06
0,6	5°	3,0	3,0	3,1	3,3	3,5	0,009	0,18	0,60	0,012	0,03	0,05
0,6	3°	4,2	4,2	4,4	4,6	4,9	0,008	0,18	0,60	0,011	0,03	0,04
0,6	7°	1,8	1,8	1,9	2,2	2,5	0,010	0,18	0,60	0,013	0,03	0,06
0,6	5°	3,0	3,0	3,1	3,3	3,4	0,009	0,18	0,60	0,012	0,03	0,05
0,6	3°	4,2	4,2	4,4	4,6	4,8	0,008	0,18	0,60	0,011	0,03	0,04
0,8	7°	2,4	2,5	2,6	2,9	3,3	0,012	0,24	0,80	0,016	0,04	0,08
0,8	5°	4,0	4,0	4,2	4,4	4,6	0,010	0,24	0,80	0,015	0,04	0,06
0,8	3°	5,6	5,7	5,8	6,1	6,5	0,009	0,24	0,80	0,013	0,04	0,05
0,8	7°	2,4	2,5	2,6	2,9	3,3	0,012	0,24	0,80	0,016	0,04	0,08
0,8	5°	4,0	4,0	4,2	4,4	4,6	0,010	0,24	0,80	0,015	0,04	0,06
0,8	3°	5,6	5,7	5,8	6,1	6,5	0,009	0,24	0,80	0,013	0,04	0,05

Abmessungen in mm  
Dimensions in mm

B

### DSTMA

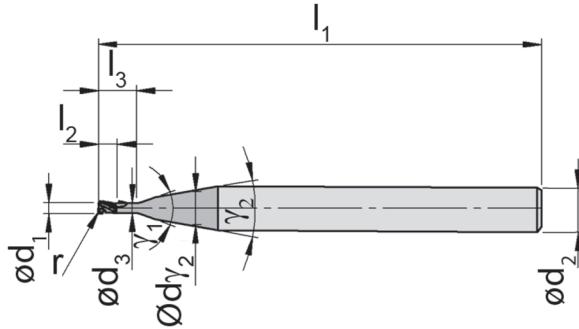
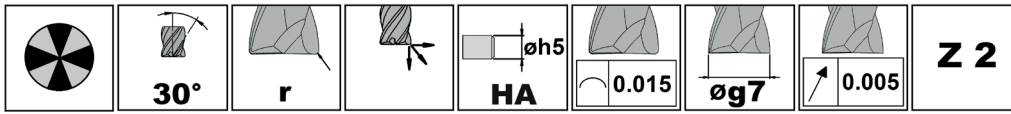

Bis Ø 3 mm vormontiert lieferbar für Toodle Schnellaufspindel (siehe Seite D2)  
Pre-assembled available up to Ø 3 mm for Toodle high-speed spindle (see page D2)

B

Bestellnummer Part number	d <sub>1</sub>	r	l <sub>2</sub>	l <sub>3</sub>	d <sub>3</sub>	d <sub>2</sub>	l <sub>1</sub>	Z	γ <sub>1</sub>	γ <sub>2</sub>	d <sub>γ2</sub>	MG3K
DSTMA.100.005.030	1,0	0,05	2,50	3,0	0,95	4	50	2	20°	-°	0	▲
DSTMA.100.005.050	1,0	0,05	2,50	5,0	0,95	4	50	2	40°	20°	2,0	▲
DSTMA.100.005.070	1,0	0,05	2,50	7,0	0,95	4	50	2	40°	20°	2,0	▲
DSTMA.100.010.030	1,0	0,10	2,50	3,0	0,95	4	50	2	20°	-°	0	▲
DSTMA.100.010.050	1,0	0,10	2,50	5,0	0,95	4	50	2	40°	20°	2,0	▲
DSTMA.100.010.070	1,0	0,10	2,50	7,0	0,95	4	50	2	40°	20°	2,0	▲
DSTMA.120.005.030	1,2	0,05	3,00	3,6	1,15	4	50	2	20°	-°	0	▲
DSTMA.120.005.050	1,2	0,05	3,00	6,0	1,15	4	50	2	40°	20°	2,0	▲
DSTMA.120.005.070	1,2	0,05	3,00	8,4	1,15	4	50	2	40°	20°	2,0	▲
DSTMA.120.010.030	1,2	0,10	3,00	3,6	1,15	4	50	2	20°	-°	0	▲
DSTMA.120.010.050	1,2	0,10	3,00	6,0	1,15	4	50	2	40°	20°	2,0	▲
DSTMA.120.010.070	1,2	0,10	3,00	8,4	1,15	4	50	2	40°	20°	2,0	▲
DSTMA.150.010.030	1,5	0,10	3,75	4,5	1,45	4	50	2	20°	-°	0	▲
DSTMA.150.010.050	1,5	0,10	3,75	7,5	1,45	4	50	2	40°	20°	2,5	▲
DSTMA.150.010.070	1,5	0,10	3,75	10,5	1,45	4	50	2	40°	20°	2,5	▲
DSTMA.150.020.030	1,5	0,20	3,75	4,5	1,45	4	50	2	20°	-°	0	▲
DSTMA.150.020.050	1,5	0,20	3,75	7,5	1,45	4	50	2	40°	20°	2,5	▲
DSTMA.150.020.070	1,5	0,20	3,75	10,5	1,45	4	50	2	40°	20°	2,5	▲
DSTMA.150.050.030	1,5	0,50	3,75	4,5	1,45	4	50	2	20°	-°	0	▲
DSTMA.150.050.050	1,5	0,50	3,75	7,5	1,45	4	50	2	40°	20°	2,5	▲
DSTMA.150.050.070	1,5	0,50	3,75	10,5	1,45	4	50	2	40°	20°	2,5	▲
DSTMA.200.010.030	2,0	0,10	5,00	6,0	1,90	4	50	2	20°	-°	0	▲
DSTMA.200.010.050	2,0	0,10	5,00	10,0	1,90	4	50	2	40°	20°	3,0	▲
DSTMA.200.010.070	2,0	0,10	5,00	14,0	1,90	4	50	2	40°	20°	3,0	▲
DSTMA.200.020.030	2,0	0,20	5,00	6,0	1,90	4	50	2	20°	-°	0	▲
DSTMA.200.020.050	2,0	0,20	5,00	10,0	1,90	4	50	2	40°	20°	3,0	▲
DSTMA.200.020.070	2,0	0,20	5,00	14,0	1,90	4	50	2	40°	20°	3,0	▲
DSTMA.200.050.030	2,0	0,50	5,00	6,0	1,90	4	50	2	20°	-°	0	▲
DSTMA.200.050.050	2,0	0,50	5,00	10,0	1,90	4	50	2	40°	20°	3,0	▲
DSTMA.200.050.070	2,0	0,50	5,00	14,0	1,90	4	50	2	40°	20°	3,0	▲

▲ ab Lager / on stock Δ 4 Wochen / 4 weeks x auf Anfrage / upon request

● empfohlen / recommended

o bedingt einsetzbar / alternative recommendation

- nicht geeignet / not suitable

■ unbeschichtete HM-Sorten / uncoated grades

■ beschichtete HM-Sorten / coated grades

■ bestückt/Cermet / brazed/Cermet



Abmessungen in mm  
Dimensions in mm



P	-
M	-
K	-
N	•
S	-
H	-

# Schnittdaten DSTMA Ø 1 - 2 mm

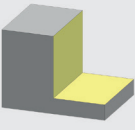
## Cutting Data DSTMA Ø 1 - 2 mm

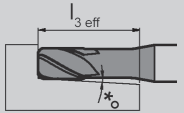

	 $vc = m/min$	 $vc = m/min$
N1.1	460	550
N1.2	480	580
N2.1	460	550
N2.2	390	470
N2.3	260	310
N3.1	330	400
N3.2	290	350
N4.1	330	400

$d_1$	 $\alpha$	 $l_{3\text{eff}}$										
		0°	0,5°	1°	2°	3°	$f_z$	$a_e$	$a_p$	$f_z$	$a_e$	$a_p$
1,0	7°	3,0	3,1	3,3	3,7	4,2	0,014	0,30	1,00	0,019	0,05	0,10
1,0	5°	5,0	5,1	5,2	5,5	5,8	0,012	0,30	1,00	0,017	0,05	0,08
1,0	3°	7,0	7,1	7,3	7,7	8,1	0,011	0,30	1,00	0,015	0,05	0,06
1,0	7°	3,0	3,1	3,3	3,7	4,2	0,014	0,30	1,00	0,019	0,05	0,10
1,0	5°	5,0	5,1	5,2	5,5	5,8	0,012	0,30	1,00	0,017	0,05	0,08
1,0	3°	7,0	7,1	7,3	7,7	8,1	0,011	0,30	1,00	0,015	0,05	0,06
1,2	7°	3,6	3,7	3,9	4,4	5,1	0,016	0,36	1,20	0,022	0,06	0,12
1,2	5°	6,0	6,1	6,3	6,6	7,0	0,014	0,36	1,20	0,020	0,06	0,10
1,2	3°	8,4	8,6	8,8	9,2	10,0	0,013	0,36	1,20	0,018	0,06	0,07
1,2	7°	3,6	3,7	3,9	4,4	5,0	0,016	0,36	1,20	0,022	0,06	0,12
1,2	5°	6,0	6,1	6,3	6,6	6,9	0,014	0,36	1,20	0,020	0,06	0,10
1,2	3°	8,4	8,6	8,8	9,2	10,0	0,013	0,36	1,20	0,018	0,06	0,07
1,5	7°	4,5	4,7	4,9	5,5	6,3	0,019	0,45	1,50	0,027	0,08	0,15
1,5	5°	7,5	7,6	7,8	8,2	8,7	0,017	0,45	1,50	0,024	0,08	0,12
1,5	3°	10,5	10,7	11,0	11,6	12,6	0,015	0,45	1,50	0,021	0,08	0,09
1,5	7°	4,5	4,7	4,9	5,5	6,3	0,019	0,45	1,50	0,027	0,08	0,15
1,5	5°	7,5	7,6	7,8	8,2	8,7	0,017	0,45	1,50	0,024	0,08	0,12
1,5	3°	10,5	10,7	11,0	11,5	12,5	0,015	0,45	1,50	0,021	0,08	0,09
1,5	7°	4,5	4,7	4,9	5,4	6,2	0,019	0,45	1,50	0,027	0,08	0,15
1,5	5°	7,5	7,6	7,8	8,2	8,6	0,017	0,45	1,50	0,024	0,08	0,12
1,5	3°	10,5	10,7	11,0	11,5	12,4	0,015	0,45	1,50	0,021	0,08	0,09
2,0	7°	6,0	6,3	6,6	7,4	8,5	0,024	0,60	2,00	0,034	0,10	0,20
2,0	5°	10,0	10,2	10,5	11,0	11,9	0,021	0,60	2,00	0,031	0,10	0,16
2,0	3°	14,0	14,3	14,7	15,4	17,6	0,019	0,60	2,00	0,027	0,10	0,12
2,0	7°	6,0	6,3	6,6	7,4	8,4	0,024	0,60	2,00	0,034	0,10	0,20
2,0	5°	10,0	10,2	10,4	11,0	11,8	0,021	0,60	2,00	0,031	0,10	0,16
2,0	3°	14,0	14,3	14,7	15,4	17,5	0,019	0,60	2,00	0,027	0,10	0,12
2,0	7°	6,0	6,2	6,6	7,3	8,3	0,024	0,60	2,00	0,034	0,10	0,20
2,0	5°	10,0	11,7	11,0	10,4	10,2	0,021	0,60	2,00	0,031	0,10	0,16
2,0	3°	14,0	14,3	14,6	15,4	17,4	0,019	0,60	2,00	0,027	0,10	0,12

Abmessungen in mm  
Dimensions in mm

B



### DSTMA

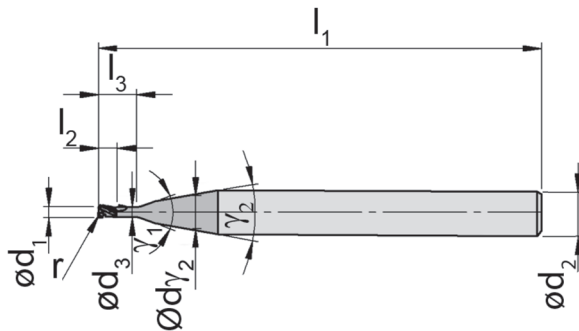
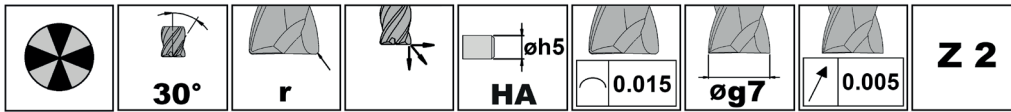

Bis Ø 3 mm vormontiert lieferbar für Toodle Schnelllaufspindel (siehe Seite D2)  
 Pre-assembled available up to Ø 3 mm for Toodle high-speed spindle (see page D2)

B

Bestellnummer Part number	d <sub>1</sub>	r	l <sub>2</sub>	l <sub>3</sub>	d <sub>3</sub>	d <sub>2</sub>	l <sub>1</sub>	Z	γ <sub>1</sub>	γ <sub>2</sub>	d <sub>γ<sub>2</sub></sub>	MG3K
DSTMA.250.010.030	2,5	0,1	6,25	7,5	2,4	4	50	2	20°	-°	0	▲
DSTMA.250.010.050	2,5	0,1	6,25	12,5	2,4	4	50	2	40°	20°	3,5	▲
DSTMA.250.010.070	2,5	0,1	6,25	17,5	2,4	4	50	2	40°	20°	3,5	▲
DSTMA.250.020.030	2,5	0,2	6,25	7,5	2,4	4	50	2	20°	-°	0	▲
DSTMA.250.020.050	2,5	0,2	6,25	12,5	2,4	4	50	2	40°	20°	3,5	▲
DSTMA.250.020.070	2,5	0,2	6,25	17,5	2,4	4	50	2	40°	20°	3,5	▲
DSTMA.250.050.030	2,5	0,5	6,25	7,5	2,4	4	50	2	20°	-°	0	▲
DSTMA.250.050.050	2,5	0,5	6,25	12,5	2,4	4	50	2	40°	20°	3,5	▲
DSTMA.250.050.070	2,5	0,5	6,25	17,5	2,4	4	50	2	40°	20°	3,5	▲
DSTMA.300.010.030	3,0	0,1	7,50	9,0	2,9	4	50	2	20°	-°	0	▲
DSTMA.300.010.050	3,0	0,1	7,50	15,0	2,9	4	50	2	40°	20°	3,5	▲
DSTMA.300.010.070	3,0	0,1	7,50	21,0	2,9	4	64	2	40°	20°	3,5	▲
DSTMA.300.020.030	3,0	0,2	7,50	9,0	2,9	4	50	2	20°	-°	0	▲
DSTMA.300.020.050	3,0	0,2	7,50	15,0	2,9	4	50	2	40°	20°	3,5	▲
DSTMA.300.020.070	3,0	0,2	7,50	21,0	2,9	4	64	2	40°	20°	3,5	▲
DSTMA.300.050.030	3,0	0,5	7,50	9,0	2,9	4	50	2	20°	-°	0	▲
DSTMA.300.050.050	3,0	0,5	7,50	15,0	2,9	4	50	2	40°	20°	3,5	▲
DSTMA.300.050.070	3,0	0,5	7,50	21,0	2,9	4	64	2	40°	20°	3,5	▲
DSTMA.300.100.030	3,0	1,0	7,50	9,0	2,9	4	50	2	20°	-°	0	▲
DSTMA.300.100.050	3,0	1,0	7,50	15,0	2,9	4	50	2	40°	20°	3,5	▲
DSTMA.300.100.070	3,0	1,0	7,50	21,0	2,9	4	64	2	40°	20°	3,5	▲

- ▲ ab Lager / on stock   Δ 4 Wochen / 4 weeks   x auf Anfrage / upon request
- empfohlen / recommended
- o bedingt einsetzbar / alternative recommendation
- nicht geeignet / not suitable
- unbeschichtete HM-Sorten / uncoated grades
- beschichtete HM-Sorten / coated grades
- bestückt/Cermet / brazed/Cermet

P	-
M	-
K	-
N	•
S	-
H	-

Abmessungen in mm  
 Dimensions in mm



HM-Sorten  
 Carbide grades

# Schnittdaten DSTMA Ø 2,5 - 3 mm

## Cutting Data DSTMA Ø 2,5 - 3 mm

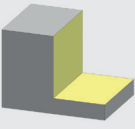
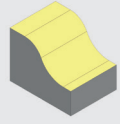

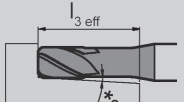
	 vc = m/min	 vc = m/min
N1.1	460	550
N1.2	480	580
N2.1	460	550
N2.2	390	470
N2.3	260	310
N3.1	330	400
N3.2	290	350
N4.1	330	400

d <sub>1</sub>												
		0°	0,5°	1°	2°	3°	f <sub>z</sub>	a <sub>e</sub>	a <sub>p</sub>	f <sub>z</sub>	a <sub>e</sub>	a <sub>p</sub>
2,5	7°	7,5	7,8	8,3	9,3	10,6	0,029	0,75	2,50	0,041	0,13	0,25
2,5	5°	12,5	12,8	13,1	13,8	∞	0,026	0,75	2,50	0,037	0,13	0,20
2,5	3°	17,5	17,9	18,3	19,8	∞	0,023	0,75	2,50	0,033	0,13	0,15
2,5	7°	7,5	7,8	8,3	9,3	10,5	0,029	0,75	2,50	0,041	0,13	0,25
2,5	5°	12,5	12,8	13,1	13,8	∞	0,026	0,75	2,50	0,037	0,13	0,20
2,5	3°	17,5	17,9	18,3	19,7	∞	0,023	0,75	2,50	0,033	0,13	0,15
2,5	7°	7,5	7,8	8,2	9,2	10,4	0,029	0,75	2,50	0,041	0,13	0,25
2,5	5°	12,5	12,7	13,1	13,7	∞	0,026	0,75	2,50	0,037	0,13	0,20
2,5	3°	17,5	17,9	18,3	19,7	∞	0,023	0,75	2,50	0,033	0,13	0,15
3,0	7°	9,0	9,4	9,9	11,2	12,7	0,034	0,90	3,00	0,049	0,15	0,30
3,0	5°	15,0	15,3	15,7	∞	∞	0,031	0,90	3,00	0,044	0,15	0,24
3,0	3°	21,0	21,5	22,3	∞	∞	0,027	0,90	3,00	0,039	0,15	0,18
3,0	7°	9,0	9,4	9,9	11,1	∞	0,034	0,90	3,00	0,049	0,15	0,30
3,0	5°	15,0	15,3	15,7	∞	∞	0,031	0,90	3,00	0,044	0,15	0,24
3,0	3°	21,0	21,5	22,3	∞	∞	0,027	0,90	3,00	0,039	0,15	0,18
3,0	7°	9,0	9,4	9,9	11,1	∞	0,034	0,90	3,00	0,049	0,15	0,30
3,0	5°	15,0	15,3	15,7	∞	19,9	0,031	0,90	3,00	0,044	0,15	0,24
3,0	3°	21,0	21,5	22,2	∞	28,4	0,027	0,90	3,00	0,039	0,15	0,18
3,0	7°	9,0	9,4	9,8	10,9	∞	0,034	0,90	3,00	0,049	0,15	0,30
3,0	5°	15,0	15,3	15,7	∞	∞	0,031	0,90	3,00	0,044	0,15	0,24
3,0	3°	21,0	21,4	22,2	∞	∞	0,027	0,90	3,00	0,039	0,15	0,18

Abmessungen in mm  
Dimensions in mm



# Schaftfräser Einschneider

## End Mill single fluted



### DSA

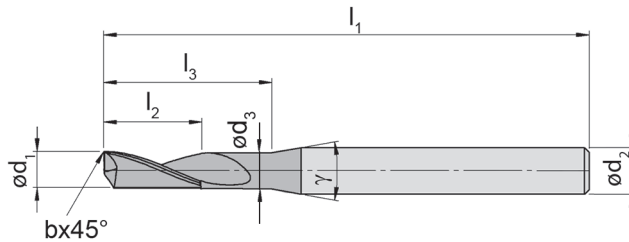
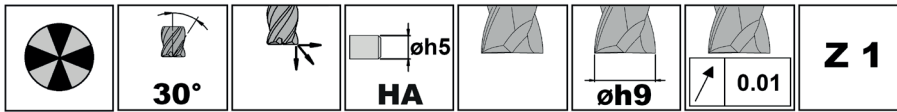

Bis Ø 3 mm vormontiert lieferbar für Toodle Schnelllaufspindel (siehe Seite D2)  
Pre-assembled available up to Ø 3 mm for Toodle high-speed spindle (see page D2)

B

Bestellnummer Part number	d <sub>1</sub>	l <sub>2</sub>	l <sub>3</sub>	d <sub>3</sub>	d <sub>2</sub>	l <sub>1</sub>	Z	γ <sub>1</sub>	γ <sub>2</sub>	d <sub>v2</sub>	MG3K
DSA.1.003.030	0,3	0,75	0,90	0,28	4	50	1	20°	-°	-	▲
DSA.1.003.050	0,3	1,05	1,50	0,28	4	50	1	40°	20°	2,0	▲
DSA.1.003.053	0,3	1,50	1,59	0,28	4	50	1	40°	20°	2,0	▲
DSA.1.004.030	0,4	1,00	1,20	0,38	4	50	1	20°	-°	-	▲
DSA.1.004.050	0,4	1,40	2,00	0,38	4	50	1	40°	20°	2,0	▲
DSA.1.004.053	0,4	2,00	2,12	0,38	4	50	1	40°	20°	2,0	▲
DSA.1.005.030	0,5	1,25	1,50	0,47	4	50	1	20°	-°	-	▲
DSA.1.005.050	0,5	1,75	2,50	0,47	4	50	1	40°	20°	2,0	▲
DSA.1.005.053	0,5	2,50	2,65	0,47	4	50	1	40°	20°	2,0	▲
DSA.1.006.030	0,6	1,50	1,80	0,56	4	50	1	20°	-°	-	▲
DSA.1.006.050	0,6	2,10	3,00	0,56	4	50	1	40°	20°	2,0	▲
DSA.1.006.053	0,6	3,00	3,18	0,56	4	50	1	40°	20°	2,0	▲
DSA.1.008.030	0,8	2,00	2,40	0,75	4	50	1	20°	-°	-	▲
DSA.1.008.050	0,8	2,80	4,00	0,75	4	50	1	40°	20°	2,0	▲
DSA.1.008.053	0,8	4,00	4,24	0,75	4	50	1	40°	20°	2,0	▲
DSA.1.010.030	1,0	2,50	3,00	0,95	4	50	1	20°	-°	-	▲
DSA.1.010.050	1,0	3,50	5,00	0,95	4	50	1	40°	20°	2,0	▲
DSA.1.010.053	1,0	5,00	5,30	0,95	4	50	1	40°	20°	2,0	▲
DSA.1.012.030	1,2	3,00	3,60	1,15	4	50	1	20°	-°	-	▲
DSA.1.012.050	1,2	4,20	6,00	1,15	4	50	1	40°	20°	2,0	▲
DSA.1.012.053	1,2	6,00	6,36	1,15	4	50	1	40°	20°	2,0	▲
DSA.1.015.030	1,5	3,75	4,50	1,45	4	50	1	20°	-°	-	▲
DSA.1.015.050	1,5	5,25	7,50	1,45	4	50	1	40°	20°	2,5	▲
DSA.1.015.053	1,5	7,50	7,95	1,45	4	50	1	40°	20°	2,5	▲
DSA.1.018.030	1,8	4,50	5,40	1,75	4	50	1	20°	-°	-	▲
DSA.1.018.050	1,8	6,30	9,00	1,75	4	50	1	40°	20°	3,0	▲
DSA.1.018.053	1,8	9,00	9,54	1,75	4	50	1	40°	20°	3,0	▲

▲ ab Lager / on stock Δ 4 Wochen / 4 weeks x auf Anfrage / upon request

● empfohlen / recommended

o bedingt einsetzbar / alternative recommendation

- nicht geeignet / not suitable

■ unbeschichtete HM-Sorten / uncoated grades

■ beschichtete HM-Sorten / coated grades

■ bestückt/Cermet / brazed/Cermet

Abmessungen in mm

Dimensions in mm

P	-
M	-
K	-
N	•
S	-
H	-



HM-Sorten  
Carbide grades

# Schnittdaten DSA Ø 0,3 - 1,8 mm

## Cutting Data DSA Ø 0,3 - 1,8 mm

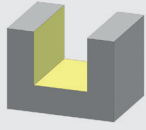
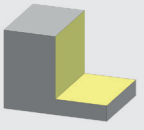

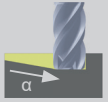
	 vc = m/min	 vc = m/min
N1.1	300	390
N1.2	320	420
N2.1	300	390
N2.2	250	330
N2.3	180	230
N3.1	200	260
N3.2	180	230
N4.1	200	260

d <sub>1</sub>	 α						
		f <sub>z</sub>	a <sub>e</sub>	a <sub>p</sub>	f <sub>z</sub>	a <sub>e</sub>	a <sub>p</sub>
0,3	7°	0,022	0,30	0,45	0,045	0,08	0,75
0,3	5°	0,016	0,30	0,45	0,031	0,08	0,75
0,3	3°	0,016	0,30	0,45	0,031	0,08	1,50
0,4	7°	0,022	0,40	0,60	0,045	0,10	1,00
0,4	5°	0,016	0,40	0,60	0,031	0,10	1,00
0,4	3°	0,016	0,40	0,60	0,031	0,10	2,00
0,5	7°	0,023	0,50	0,75	0,045	0,13	1,25
0,5	5°	0,016	0,50	0,75	0,032	0,13	1,25
0,5	3°	0,016	0,50	0,75	0,032	0,13	2,50
0,6	7°	0,023	0,60	0,90	0,045	0,15	1,50
0,6	5°	0,016	0,60	0,90	0,032	0,15	1,50
0,6	3°	0,016	0,60	0,90	0,032	0,15	3,00
0,8	7°	0,023	0,80	1,20	0,046	0,20	2,00
0,8	5°	0,016	0,80	1,20	0,032	0,20	2,00
0,8	3°	0,016	0,80	1,20	0,032	0,20	4,00
1,0	7°	0,023	1,00	1,50	0,046	0,25	2,50
1,0	5°	0,016	1,00	1,50	0,032	0,25	2,50
1,0	3°	0,016	1,00	1,50	0,032	0,25	5,00
1,2	7°	0,023	1,20	1,80	0,047	0,30	3,00
1,2	5°	0,016	1,20	1,80	0,033	0,30	3,00
1,2	3°	0,016	1,20	1,80	0,033	0,30	6,00
1,5	7°	0,024	1,50	2,25	0,048	0,38	3,75
1,5	5°	0,017	1,50	2,25	0,033	0,38	3,75
1,5	3°	0,017	1,50	2,25	0,033	0,38	7,50
1,8	7°	0,024	1,80	2,70	0,048	0,45	4,50
1,8	5°	0,017	1,80	2,70	0,034	0,45	4,50
1,8	3°	0,017	1,80	2,70	0,034	0,45	9,00

Abmessungen in mm  
Dimensions in mm

B

# Schaftfräser Einschneider

## End Mill single fluted



### DSA

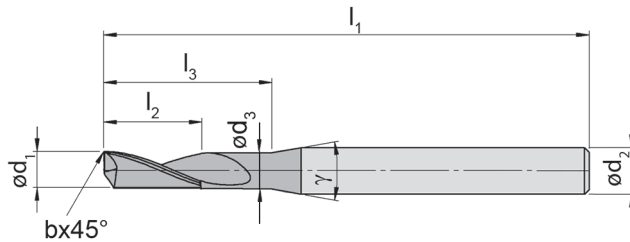
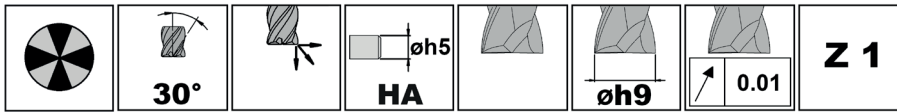

Bis Ø 3 mm vormontiert lieferbar für Toodle Schnellaufspindel (siehe Seite D2)  
Pre-assembled available up to Ø 3 mm for Toodle high-speed spindle (see page D2)

B

Bestellnummer Part number	d <sub>1</sub>	b	l <sub>2</sub>	l <sub>3</sub>	d <sub>3</sub>	d <sub>2</sub>	l <sub>1</sub>	Z	γ <sub>1</sub>	γ <sub>2</sub>	d <sub>γ<sub>2</sub></sub>	MG3K
DSA.1.020.030	2,0	-	5,00	6,00	1,9	4	50	1	20°	-°	-	▲
DSA.1.020.050	2,0	-	7,00	10,00	1,9	4	50	1	40°	20°	3,0	▲
DSA.1.020.053	2,0	-	10,00	10,60	1,9	4	50	1	40°	20°	3,0	▲
DSA.1.025.030	2,5	-	6,25	7,50	2,4	4	50	1	20°	-°	-	▲
DSA.1.025.050	2,5	-	8,75	12,50	2,4	4	50	1	40°	20°	3,5	▲
DSA.1.025.053	2,5	-	12,50	13,25	2,4	4	64	1	40°	20°	3,5	▲
DSA.1.030.030	3,0	0,1	7,50	9,00	2,9	4	50	1	20°	-°	-	▲
DSA.1.030.050	3,0	0,1	10,50	15,00	2,9	4	64	1	40°	20°	3,5	▲
DSA.1.030.053	3,0	0,1	15,00	15,90	2,9	4	64	1	40°	20°	3,5	▲
DSA.1.040.030	4,0	0,1	10,00	12,00	3,8	6	54	1	20°	-°	-	▲
DSA.1.040.050	4,0	0,1	14,00	20,00	3,8	6	64	1	20°	-°	-	▲
DSA.1.040.053	4,0	0,1	20,00	21,20	3,8	6	64	1	20°	-°	-	▲
DSA.1.050.030	5,0	0,1	12,50	15,00	4,7	6	64	1	20°	-°	-	▲
DSA.1.050.050	5,0	0,1	17,50	25,00	4,7	6	64	1	20°	-°	-	▲
DSA.1.050.053	5,0	0,1	25,00	26,50	4,7	6	64	1	20°	-°	-	▲
DSA.1.060.030	6,0	0,2	15,00	18,00	5,6	6	64	1	-°	-°	-	▲
DSA.1.060.050	6,0	0,2	21,00	30,00	5,6	6	82	1	-°	-°	-	▲
DSA.1.060.053	6,0	0,2	30,00	31,80	5,6	6	82	1	-°	-°	-	▲
DSA.1.080.030	8,0	0,2	20,00	24,00	7,5	8	64	1	-°	-°	-	▲
DSA.1.080.050	8,0	0,2	28,00	40,00	7,5	8	82	1	-°	-°	-	▲
DSA.1.080.053	8,0	0,2	40,00	42,40	7,5	8	82	1	-°	-°	-	▲
DSA.1.100.030	10,0	0,2	25,00	30,00	9,5	10	82	1	-°	-°	-	▲
DSA.1.100.050	10,0	0,2	35,00	50,00	9,5	10	108	1	-°	-°	-	▲
DSA.1.100.053	10,0	0,2	50,00	53,00	9,5	10	108	1	-°	-°	-	▲
DSA.1.120.030	12,0	0,2	30,00	36,00	11,5	12	82	1	-°	-°	-	▲
DSA.1.120.050	12,0	0,2	42,00	60,00	11,5	12	108	1	-°	-°	-	▲
DSA.1.120.053	12,0	0,2	60,00	63,60	11,5	12	108	1	-°	-°	-	▲

▲ ab Lager / on stock Δ 4 Wochen / 4 weeks x auf Anfrage / upon request

● empfohlen / recommended

o bedingt einsetzbar / alternative recommendation

- nicht geeignet / not suitable

■ unbeschichtete HM-Sorten / uncoated grades

■ beschichtete HM-Sorten / coated grades

■ bestückt/Cermet / brazed/Cermet

Abmessungen in mm

Dimensions in mm

P	-
M	-
K	-
N	•
S	-
H	-



HM-Sorten  
Carbide grades

# Schnittdaten DSA Ø 2 - 12 mm

## Cutting Data DSA Ø 2 - 12 mm

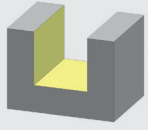
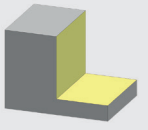

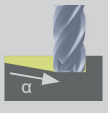
	 vc = m/min	 vc = m/min
N1.1	300	390
N1.2	320	420
N2.1	300	390
N2.2	250	330
N2.3	180	230
N3.1	200	260
N3.2	180	230
N4.1	200	260

d <sub>1</sub>							
		f <sub>z</sub>	a <sub>e</sub>	a <sub>p</sub>	f <sub>z</sub>	a <sub>e</sub>	a <sub>p</sub>
2,0	7°	0,027	2,00	3,00	0,045	0,50	5,00
2,0	5°	0,019	2,00	3,00	0,031	0,50	5,00
2,0	3°	0,019	2,00	3,00	0,031	0,50	10,00
2,5	7°	0,032	2,50	3,75	0,052	0,63	6,25
2,5	5°	0,022	2,50	3,75	0,037	0,63	6,25
2,5	3°	0,022	2,50	3,75	0,037	0,63	12,50
3,0	7°	0,037	3,00	4,50	0,060	0,75	7,50
3,0	5°	0,026	3,00	4,50	0,042	0,75	7,50
3,0	3°	0,026	3,00	4,50	0,042	0,75	15,00
4,0	7°	0,047	4,00	6,00	0,075	1,00	10,00
4,0	5°	0,033	4,00	6,00	0,053	1,00	10,00
4,0	3°	0,033	4,00	6,00	0,053	1,00	20,00
5,0	7°	0,057	5,00	7,50	0,091	1,25	12,50
5,0	5°	0,040	5,00	7,50	0,063	1,25	12,50
5,0	3°	0,040	5,00	7,50	0,063	1,25	25,00
6,0	7°	0,067	6,00	9,00	0,106	1,50	15,00
6,0	5°	0,047	6,00	9,00	0,074	1,50	15,00
6,0	3°	0,047	6,00	9,00	0,074	1,50	30,00
8,0	7°	0,087	8,00	12,00	0,137	2,00	20,00
8,0	5°	0,061	8,00	12,00	0,096	2,00	20,00
8,0	3°	0,061	8,00	12,00	0,096	2,00	40,00
10,0	7°	0,107	10,00	15,00	0,168	2,50	25,00
10,0	5°	0,075	10,00	15,00	0,117	2,50	25,00
10,0	3°	0,075	10,00	15,00	0,117	2,50	50,00
12,0	7°	0,127	12,00	18,00	0,198	3,00	30,00
12,0	5°	0,089	12,00	18,00	0,139	3,00	30,00
12,0	3°	0,089	12,00	18,00	0,139	3,00	60,00

Abmessungen in mm  
Dimensions in mm

B

# Schaftfräser Vollradius

## Ball Nose End Mill



### DSKA

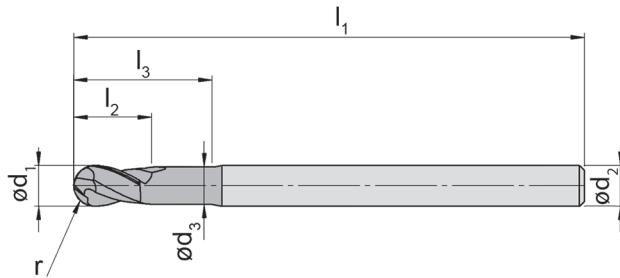
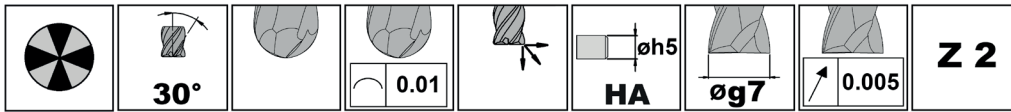

B

Bestellnummer Part number	d <sub>1</sub>	r	l <sub>2</sub>	l <sub>3</sub>	d <sub>3</sub>	d <sub>2</sub>	l <sub>1</sub>	Z	γ	MG3K
DSKA.2.040.030	4	2,0	10,0	12	3,8	6	64	2	20°	▲
DSKA.2.040.050	4	2,0	10,0	20	3,8	6	64	2	20°	▲
DSKA.2.040.070	4	2,0	10,0	28	3,8	6	70	2	20°	▲
DSKA.2.050.030	5	2,5	12,5	15	4,7	6	64	2	20°	▲
DSKA.2.050.050	5	2,5	12,5	25	4,7	6	64	2	20°	▲
DSKA.2.050.070	5	2,5	12,5	35	4,7	6	82	2	20°	▲
DSKA.2.060.030	6	3,0	15,0	18	5,6	6	64	2	-°	▲
DSKA.2.060.050	6	3,0	15,0	30	5,6	6	82	2	-°	▲
DSKA.2.060.070	6	3,0	15,0	42	5,6	6	82	2	-°	▲
DSKA.2.080.030	8	4,0	20,0	24	7,5	8	64	2	-°	▲
DSKA.2.080.050	8	4,0	20,0	40	7,5	8	82	2	-°	▲
DSKA.2.080.070	8	4,0	20,0	56	7,5	8	108	2	-°	▲
DSKA.2.100.030	10	5,0	25,0	30	9,5	10	82	2	-°	▲
DSKA.2.100.050	10	5,0	25,0	50	9,5	10	108	2	-°	▲
DSKA.2.100.070	10	5,0	25,0	70	9,5	10	120	2	-°	▲
DSKA.2.120.030	12	6,0	30,0	36	11,5	12	82	2	-°	▲
DSKA.2.120.050	12	6,0	30,0	60	11,5	12	108	2	-°	▲
DSKA.2.120.070	12	6,0	30,0	84	11,5	12	140	2	-°	▲
DSKA.2.160.030	16	8,0	40,0	48	15,0	16	108	2	-°	▲
DSKA.2.160.050	16	8,0	40,0	80	15,0	16	140	2	-°	▲
DSKA.2.200.030	20	10,0	50,0	60	19,0	20	120	2	-°	▲
DSKA.2.200.050	20	10,0	50,0	100	19,0	20	163	2	-°	▲

▲ ab Lager / on stock Δ 4 Wochen / 4 weeks x auf Anfrage / upon request

● empfohlen / recommended

o bedingt einsetzbar / alternative recommendation

- nicht geeignet / not suitable

■ unbeschichtete HM-Sorten / uncoated grades

■ beschichtete HM-Sorten / coated grades

■ bestückt/Cermet / brazed/Cermet

Abmessungen in mm

Dimensions in mm

P	-
M	-
K	-
N	•
S	-
H	-



HM-Sorten  
Carbide grades

# Schnittdaten DSKA Ø 4 - 20 mm

## Cutting Data DSKA Ø 4 - 20 mm

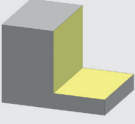
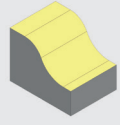

	 vc = m/min	 vc = m/min
N1.1	460	550
N1.2	480	580
N2.1	460	550
N2.2	390	470
N2.3	260	310
N3.1	330	400
N3.2	290	350
N4.1	330	400

d <sub>1</sub>							
		f <sub>z</sub>	a <sub>e</sub>	a <sub>p</sub>	f <sub>z</sub>	a <sub>e</sub>	a <sub>p</sub>
4	15°	0,044	1,20	4,00	0,037	0,12	0,40
4	10°	0,040	1,20	4,00	0,033	0,12	0,32
4	5°	0,035	1,20	4,00	0,030	0,12	0,24
5	15°	0,054	1,50	5,00	0,047	0,13	0,50
5	10°	0,049	1,50	5,00	0,042	0,13	0,40
5	5°	0,043	1,50	5,00	0,037	0,13	0,30
6	15°	0,064	1,80	6,00	0,056	0,14	0,60
6	10°	0,058	1,80	6,00	0,051	0,14	0,48
6	5°	0,052	1,80	6,00	0,045	0,14	0,36
8	15°	0,085	2,40	8,00	0,077	0,16	0,80
8	10°	0,076	2,40	8,00	0,069	0,16	0,64
8	5°	0,068	2,40	8,00	0,061	0,16	0,48
10	15°	0,105	3,00	10,00	0,097	0,18	1,00
10	10°	0,094	3,00	10,00	0,088	0,18	0,80
10	5°	0,084	3,00	10,00	0,078	0,18	0,60
12	15°	0,125	3,60	12,00	0,118	0,20	1,20
12	10°	0,113	3,60	12,00	0,107	0,20	0,96
12	5°	0,100	3,60	12,00	0,095	0,20	0,72
16	15°	0,166	4,80	16,00	0,161	0,24	1,60
16	10°	0,149	4,80	16,00	0,145	0,24	1,28
20	15°	0,206	6,00	20,00	0,204	0,28	2,00
20	10°	0,186	6,00	20,00	0,184	0,28	1,60

Abmessungen in mm  
Dimensions in mm





# Schaftfräser, scharfkantig

End Mill, sharp



## DSA

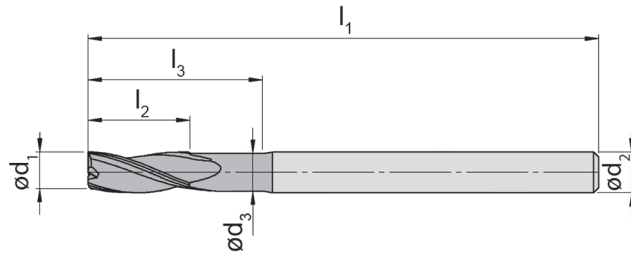
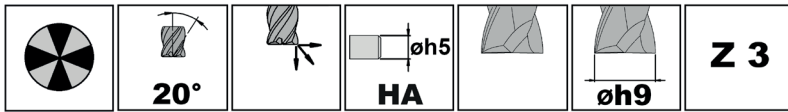

B

Bestellnummer Part number	d <sub>1</sub>	l <sub>2</sub>	l <sub>3</sub>	d <sub>3</sub>	d <sub>2</sub>	l <sub>1</sub>	Z	γ	MG3K
DSA.3.040.030	4	10,0	12,0	3,8	6	64	3	20°	▲
DSA.3.040.050	4	10,0	20,0	3,8	6	64	3	20°	▲
DSA.3.040.053	4	20,0	21,2	3,8	6	64	3	20°	▲
DSA.3.040.070	4	20,0	28,0	3,8	6	70	3	20°	▲
DSA.3.050.030	5	12,5	15,0	4,7	6	64	3	20°	▲
DSA.3.050.050	5	12,5	25,0	4,7	6	64	3	20°	▲
DSA.3.050.053	5	25,0	26,5	4,7	6	64	3	20°	▲
DSA.3.050.070	5	25,0	35,0	4,7	6	82	3	20°	▲
DSA.3.060.030	6	15,0	18,0	5,6	6	64	3	-°	▲
DSA.3.060.050	6	15,0	30,0	5,6	6	82	3	-°	▲
DSA.3.060.053	6	30,0	31,8	5,6	6	82	3	-°	▲
DSA.3.060.070	6	30,0	42,0	5,6	6	82	3	-°	▲
DSA.3.080.030	8	20,0	24,0	7,5	8	64	3	-°	▲
DSA.3.080.050	8	20,0	40,0	7,5	8	82	3	-°	▲
DSA.3.080.053	8	40,0	42,4	7,5	8	82	3	-°	▲
DSA.3.080.070	8	40,0	56,0	7,5	8	108	3	-°	▲
DSA.3.100.030	10	25,0	30,0	9,5	10	82	3	-°	▲
DSA.3.100.050	10	25,0	50,0	9,5	10	108	3	-°	▲
DSA.3.100.053	10	50,0	53,0	9,5	10	108	3	-°	▲
DSA.3.100.070	10	50,0	70,0	9,5	10	120	3	-°	▲
DSA.3.120.030	12	30,0	36,0	11,5	12	82	3	-°	▲
DSA.3.120.050	12	30,0	60,0	11,5	12	108	3	-°	▲
DSA.3.120.053	12	60,0	63,6	11,5	12	108	3	-°	▲
DSA.3.120.070	12	60,0	84,0	11,5	12	140	3	-°	▲
DSA.3.160.030	16	40,0	48,0	15,0	16	108	3	-°	▲
DSA.3.160.050	16	40,0	80,0	15,0	16	140	3	-°	▲
DSA.3.160.053	16	80,0	84,8	15,0	16	140	3	-°	▲
DSA.3.200.027	20	50,0	54,0	19,0	20	108	3	-°	▲
DSA.3.200.050	20	50,0	100,0	19,0	20	163	3	-°	▲
DSA.3.200.053	20	100,0	106,0	19,0	20	163	3	-°	▲

▲ ab Lager / on stock Δ 4 Wochen / 4 weeks x auf Anfrage / upon request

● empfohlen / recommended

o bedingt einsetzbar / alternative recommendation

- nicht geeignet / not suitable

■ unbeschichtete HM-Sorten / uncoated grades

■ beschichtete HM-Sorten / coated grades

■ bestückt/Cermet / brazed/Cermet

Abmessungen in mm

Dimensions in mm

P	-
M	-
K	-
N	•
S	-
H	-



HM-Sorten  
Carbide grades

# Schnittdaten DSA Ø 4 - 20 mm

## Cutting Data DSA Ø 4 - 20 mm

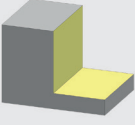
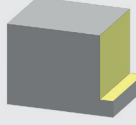

	 vc = m/min	 vc = m/min
N1.1	420	500
N1.2	440	530
N2.1	420	500
N2.2	350	420
N2.3	230	280
N3.1	290	350
N3.2	250	300
N4.1	290	350

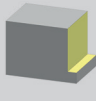
d <sub>1</sub>							
		f <sub>z</sub>	a <sub>e</sub>	a <sub>p</sub>	f <sub>z</sub>	a <sub>e</sub>	a <sub>p</sub>
4	7°	0,020	1,00	10,00	0,018	0,20	10,00
4	5°	0,014	1,00	10,00	0,012	0,20	10,00
4	3°	0,014	1,00	20,00	0,012	0,20	20,00
4	3°	0,008	1,00	20,00	0,007	0,20	20,00
5	7°	0,028	1,25	12,50	0,027	0,25	12,50
5	5°	0,020	1,25	12,50	0,019	0,25	12,50
5	3°	0,020	1,25	25,00	0,019	0,25	25,00
5	3°	0,011	1,25	25,00	0,011	0,25	25,00
6	7°	0,036	1,50	15,00	0,036	0,30	15,00
6	5°	0,025	1,50	15,00	0,025	0,30	15,00
6	3°	0,025	1,50	30,00	0,025	0,30	30,00
6	3°	0,014	1,50	30,00	0,014	0,30	30,00
8	7°	0,052	2,00	20,00	0,053	0,40	20,00
8	5°	0,036	2,00	20,00	0,037	0,40	20,00
8	3°	0,036	2,00	40,00	0,037	0,40	40,00
8	3°	0,021	2,00	40,00	0,021	0,40	40,00
10	7°	0,068	2,50	25,00	0,071	0,50	25,00
10	5°	0,048	2,50	25,00	0,050	0,50	25,00
10	3°	0,048	2,50	50,00	0,050	0,50	50,00
10	3°	0,027	2,50	50,00	0,029	0,50	50,00
12	7°	0,084	3,00	30,00	0,089	0,60	30,00
12	5°	0,059	3,00	30,00	0,062	0,60	30,00
12	3°	0,059	3,00	60,00	0,062	0,60	60,00
12	3°	0,034	3,00	60,00	0,036	0,60	60,00
16	7°	0,116	4,00	40,00	0,125	0,80	40,00
16	5°	0,081	4,00	40,00	0,088	0,80	40,00
16	3°	0,081	4,00	80,00	0,088	0,80	80,00
20	7°	0,148	5,00	50,00	0,161	1,00	50,00
20	5°	0,104	5,00	50,00	0,113	1,00	50,00
20	3°	0,104	5,00	100,00	0,113	1,00	100,00

Abmessungen in mm  
Dimensions in mm

B

# Schaftfräser, Eckenradius

End Mill, corner radius



## DSRA

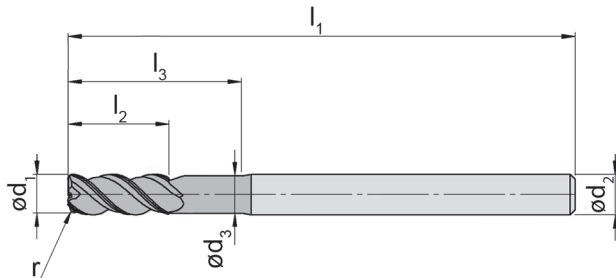
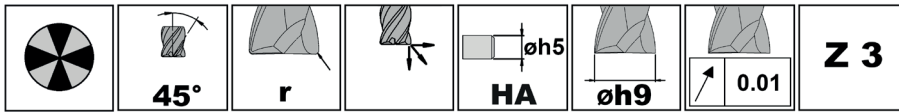

B

Bestellnummer Part number	d <sub>1</sub>	r	l <sub>2</sub>	l <sub>3</sub>	d <sub>3</sub>	d <sub>2</sub>	l <sub>1</sub>	Z	γ	MG3K
DSRA.3.040.010.030	4	0,1	10,0	12,0	3,8	6	64	3	20°	▲
DSRA.3.040.010.050	4	0,1	10,0	20,0	3,8	6	64	3	20°	▲
DSRA.3.040.010.053	4	0,1	20,0	21,2	3,8	6	64	3	20°	▲
DSRA.3.040.010.070	4	0,1	20,0	28,0	3,8	6	70	3	20°	▲
DSRA.3.040.050.030	4	0,5	10,0	12,0	3,8	6	64	3	20°	▲
DSRA.3.040.050.050	4	0,5	10,0	20,0	3,8	6	64	3	20°	▲
DSRA.3.040.050.053	4	0,5	20,0	21,2	3,8	6	64	3	20°	▲
DSRA.3.040.050.070	4	0,5	20,0	28,0	3,8	6	70	3	20°	▲
DSRA.3.040.100.030	4	1,0	10,0	12,0	3,8	6	64	3	20°	▲
DSRA.3.040.100.050	4	1,0	10,0	20,0	3,8	6	64	3	20°	▲
DSRA.3.040.100.053	4	1,0	20,0	21,2	3,8	6	64	3	20°	▲
DSRA.3.040.100.070	4	1,0	20,0	28,0	3,8	6	70	3	20°	▲
DSRA.3.050.010.030	5	0,1	12,5	15,0	4,7	6	64	3	20°	▲
DSRA.3.050.010.050	5	0,1	12,5	25,0	4,7	6	64	3	20°	▲
DSRA.3.050.010.053	5	0,1	25,0	26,5	4,7	6	64	3	20°	▲
DSRA.3.050.010.070	5	0,1	25,0	35,0	4,7	6	82	3	20°	▲
DSRA.3.050.050.030	5	0,5	12,5	15,0	4,7	6	64	3	20°	▲
DSRA.3.050.050.050	5	0,5	12,5	25,0	4,7	6	64	3	20°	▲
DSRA.3.050.050.053	5	0,5	25,0	26,5	4,7	6	64	3	20°	▲
DSRA.3.050.050.070	5	0,5	25,0	35,0	4,7	6	82	3	20°	▲
DSRA.3.050.100.030	5	1,0	12,5	15,0	4,7	6	64	3	20°	▲
DSRA.3.050.100.050	5	1,0	12,5	25,0	4,7	6	64	3	20°	▲
DSRA.3.050.100.053	5	1,0	25,0	26,5	4,7	6	64	3	20°	▲
DSRA.3.050.100.070	5	1,0	25,0	35,0	4,7	6	82	3	20°	▲

▲ ab Lager / on stock Δ 4 Wochen / 4 weeks x auf Anfrage / upon request

● empfohlen / recommended

o bedingt einsetzbar / alternative recommendation

- nicht geeignet / not suitable

■ unbeschichtete HM-Sorten / uncoated grades

■ beschichtete HM-Sorten / coated grades

■ bestückt/Cermet / brazed/Cermet

Abmessungen in mm

Dimensions in mm

P	-
M	-
K	-
N	•
S	-
H	-



HM-Sorten  
Carbide grades

# Schnittdaten DSRA Ø 4 - 5 mm

## Cutting Data DSTMA Ø 4 - 5 mm

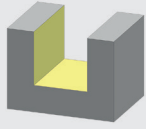
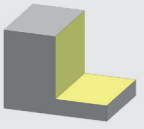

	 vc = m/min	 vc = m/min
N1.1	460	550
N1.2	480	580
N2.1	460	550
N2.2	390	470
N2.3	260	310
N3.1	330	400
N3.2	290	350
N4.1	330	400

d <sub>1</sub>							
		f <sub>z</sub>	a <sub>e</sub>	a <sub>p</sub>	f <sub>z</sub>	a <sub>e</sub>	a <sub>p</sub>
4	7°	0,014	4,00	6,00	0,007	0,80	10,00
4	5°	0,010	4,00	6,00	0,005	0,80	10,00
4	3°	0,010	4,00	6,00	0,005	0,80	20,00
4	3°	0,006	4,00	6,00	0,003	0,80	20,00
4	7°	0,014	4,00	6,00	0,007	0,80	10,00
4	5°	0,010	4,00	6,00	0,005	0,80	10,00
4	3°	0,010	4,00	6,00	0,005	0,80	20,00
4	3°	0,006	4,00	6,00	0,003	0,80	20,00
4	7°	0,014	4,00	6,00	0,007	0,80	10,00
4	5°	0,010	4,00	6,00	0,005	0,80	10,00
4	3°	0,010	4,00	6,00	0,005	0,80	20,00
4	3°	0,006	4,00	6,00	0,003	0,80	20,00
5	7°	0,019	5,00	7,50	0,011	1,00	12,50
5	5°	0,013	5,00	7,50	0,008	1,00	12,50
5	3°	0,013	5,00	7,50	0,008	1,00	25,00
5	3°	0,008	5,00	7,50	0,004	1,00	25,00
5	7°	0,019	5,00	7,50	0,011	1,00	12,50
5	5°	0,013	5,00	7,50	0,008	1,00	12,50
5	3°	0,013	5,00	7,50	0,008	1,00	25,00
5	3°	0,008	5,00	7,50	0,004	1,00	25,00
5	7°	0,019	5,00	7,50	0,011	1,00	12,50
5	5°	0,013	5,00	7,50	0,008	1,00	12,50
5	3°	0,013	5,00	7,50	0,008	1,00	25,00
5	3°	0,008	5,00	7,50	0,004	1,00	25,00

Abmessungen in mm  
Dimensions in mm



# Schaftfräser, Eckenradius

End Mill, corner radius



## DSRA

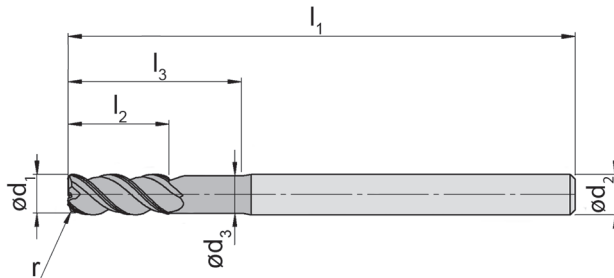
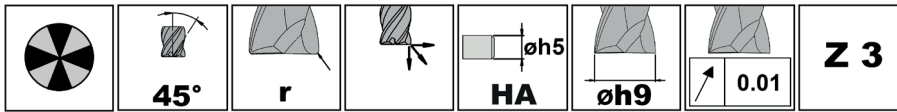

B

Bestellnummer Part number	d <sub>1</sub>	r	l <sub>2</sub>	l <sub>3</sub>	d <sub>3</sub>	d <sub>2</sub>	l <sub>1</sub>	Z	MG3K
DSRA.3.060.010.030	6	0,1	15	18,0	5,6	6	64	3	▲
DSRA.3.060.010.050	6	0,1	15	30,0	5,6	6	82	3	▲
DSRA.3.060.010.053	6	0,1	30	31,8	5,6	6	82	3	▲
DSRA.3.060.010.070	6	0,1	30	42,0	5,6	6	82	3	▲
DSRA.3.060.050.030	6	0,5	15	18,0	5,6	6	64	3	▲
DSRA.3.060.050.050	6	0,5	15	30,0	5,6	6	82	3	▲
DSRA.3.060.050.053	6	0,5	30	31,8	5,6	6	82	3	▲
DSRA.3.060.050.070	6	0,5	30	42,0	5,6	6	82	3	▲
DSRA.3.060.100.030	6	1,0	15	18,0	5,6	6	64	3	▲
DSRA.3.060.100.050	6	1,0	15	30,0	5,6	6	82	3	▲
DSRA.3.060.100.053	6	1,0	30	31,8	5,6	6	82	3	▲
DSRA.3.060.100.070	6	1,0	30	42,0	5,6	6	82	3	▲
DSRA.3.060.250.030	6	2,5	15	18,0	5,6	6	64	3	▲
DSRA.3.060.250.050	6	2,5	15	30,0	5,6	6	82	3	▲
DSRA.3.060.250.053	6	2,5	30	31,8	5,6	6	82	3	▲
DSRA.3.060.250.070	6	2,5	30	42,0	5,6	6	82	3	▲
DSRA.3.080.010.030	8	0,1	20	24,0	7,5	8	64	3	▲
DSRA.3.080.010.050	8	0,1	20	40,0	7,5	8	82	3	▲
DSRA.3.080.010.053	8	0,1	40	42,4	7,5	8	82	3	▲
DSRA.3.080.010.070	8	0,1	40	56,0	7,5	8	108	3	▲
DSRA.3.080.050.030	8	0,5	20	24,0	7,5	8	64	3	▲
DSRA.3.080.050.050	8	0,5	20	40,0	7,5	8	82	3	▲
DSRA.3.080.050.053	8	0,5	40	42,4	7,5	8	82	3	▲
DSRA.3.080.050.070	8	0,5	40	56,0	7,5	8	108	3	▲
DSRA.3.080.100.030	8	1,0	20	24,0	7,5	8	64	3	▲
DSRA.3.080.100.050	8	1,0	20	40,0	7,5	8	82	3	▲
DSRA.3.080.100.053	8	1,0	40	42,4	7,5	8	82	3	▲
DSRA.3.080.100.070	8	1,0	40	56,0	7,5	8	108	3	▲
DSRA.3.080.250.030	8	2,5	20	24,0	7,5	8	64	3	▲
DSRA.3.080.250.050	8	2,5	20	40,0	7,5	8	82	3	▲
DSRA.3.080.250.053	8	2,5	40	42,4	7,5	8	82	3	▲
DSRA.3.080.250.070	8	2,5	40	56,0	7,5	8	108	3	▲

▲ ab Lager / on stock Δ 4 Wochen / 4 weeks x auf Anfrage / upon request

● empfohlen / recommended

o bedingt einsetzbar / alternative recommendation

- nicht geeignet / not suitable

■ unbeschichtete HM-Sorten / uncoated grades

■ beschichtete HM-Sorten / coated grades

■ bestückt/Cermet / brazed/Cermet

Abmessungen in mm

Dimensions in mm



P	-
M	-
K	-
N	•
S	-
H	-

# Schnittdaten DSRA Ø 6 - 8 mm

Cutting Data DSRA Ø 6 - 8 mm

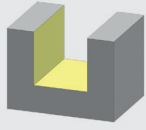
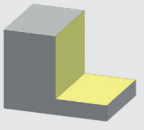

	 vc = m/min	 vc = m/min
N1.1	350	460
N1.2	370	480
N2.1	350	460
N2.2	300	390
N2.3	200	260
N3.1	250	330
N3.2	220	290
N4.1	250	330

d <sub>1</sub>							
		f <sub>z</sub>	a <sub>e</sub>	a <sub>p</sub>	f <sub>z</sub>	a <sub>e</sub>	a <sub>p</sub>
6	7°	0,024	6,00	9,00	0,016	1,20	15,00
6	5°	0,017	6,00	9,00	0,011	1,20	15,00
6	3°	0,017	6,00	9,00	0,011	1,20	30,00
6	3°	0,010	6,00	9,00	0,006	1,20	30,00
6	7°	0,024	6,00	9,00	0,016	1,20	15,00
6	5°	0,017	6,00	9,00	0,011	1,20	15,00
6	3°	0,017	6,00	9,00	0,011	1,20	30,00
6	3°	0,010	6,00	9,00	0,006	1,20	30,00
6	7°	0,024	6,00	9,00	0,016	1,20	15,00
6	5°	0,017	6,00	9,00	0,011	1,20	15,00
6	3°	0,017	6,00	9,00	0,011	1,20	30,00
6	3°	0,010	6,00	9,00	0,006	1,20	30,00
6	7°	0,024	6,00	9,00	0,016	1,20	15,00
6	5°	0,017	6,00	9,00	0,011	1,20	15,00
6	3°	0,017	6,00	9,00	0,011	1,20	30,00
6	3°	0,010	6,00	9,00	0,006	1,20	30,00
6	7°	0,024	6,00	9,00	0,016	1,20	15,00
6	5°	0,017	6,00	9,00	0,011	1,20	15,00
6	3°	0,017	6,00	9,00	0,011	1,20	30,00
6	3°	0,010	6,00	9,00	0,006	1,20	30,00
8	7°	0,034	8,00	12,00	0,025	1,60	20,00
8	5°	0,024	8,00	12,00	0,017	1,60	20,00
8	3°	0,024	8,00	12,00	0,017	1,60	40,00
8	3°	0,014	8,00	12,00	0,010	1,60	40,00
8	7°	0,034	8,00	12,00	0,025	1,60	20,00
8	5°	0,024	8,00	12,00	0,017	1,60	20,00
8	3°	0,024	8,00	12,00	0,017	1,60	40,00
8	3°	0,014	8,00	12,00	0,010	1,60	40,00
8	7°	0,034	8,00	12,00	0,025	1,60	20,00
8	5°	0,024	8,00	12,00	0,017	1,60	20,00
8	3°	0,024	8,00	12,00	0,017	1,60	40,00
8	3°	0,014	8,00	12,00	0,010	1,60	40,00
8	7°	0,034	8,00	12,00	0,025	1,60	20,00
8	5°	0,024	8,00	12,00	0,017	1,60	20,00
8	3°	0,024	8,00	12,00	0,017	1,60	40,00
8	3°	0,014	8,00	12,00	0,010	1,60	40,00

Abmessungen in mm  
Dimensions in mm

B

# Schaftfräser, Eckenradius

End Mill, corner radius



## DSRA

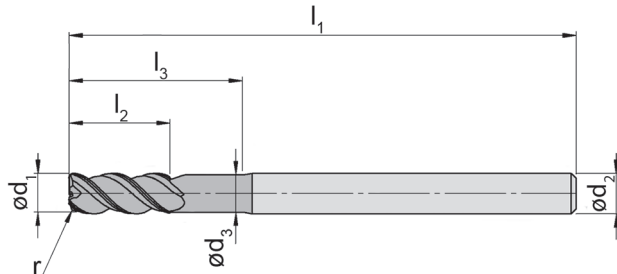
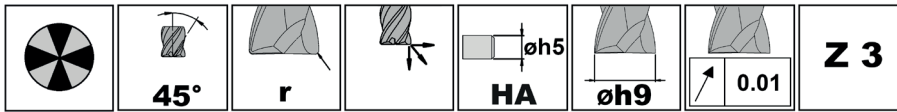

B

Bestellnummer Part number	d <sub>1</sub>	r	l <sub>2</sub>	l <sub>3</sub>	d <sub>3</sub>	d <sub>2</sub>	l <sub>1</sub>	Z	MG3K
DSRA.3.100.010.030	10	0,1	25	30,0	9,5	10	82	3	▲
DSRA.3.100.010.050	10	0,1	25	50,0	9,5	10	108	3	▲
DSRA.3.100.010.053	10	0,1	50	53,0	9,5	10	108	3	▲
DSRA.3.100.010.070	10	0,1	50	70,0	9,5	10	120	3	▲
DSRA.3.100.050.030	10	0,5	25	30,0	9,5	10	82	3	▲
DSRA.3.100.050.050	10	0,5	25	50,0	9,5	10	108	3	▲
DSRA.3.100.050.053	10	0,5	50	53,0	9,5	10	108	3	▲
DSRA.3.100.050.070	10	0,5	50	70,0	9,5	10	120	3	▲
DSRA.3.100.100.030	10	1,0	25	30,0	9,5	10	82	3	▲
DSRA.3.100.100.050	10	1,0	25	50,0	9,5	10	108	3	▲
DSRA.3.100.100.053	10	1,0	50	53,0	9,5	10	108	3	▲
DSRA.3.100.100.070	10	1,0	50	70,0	9,5	10	120	3	▲
DSRA.3.100.250.030	10	2,5	25	30,0	9,5	10	82	3	▲
DSRA.3.100.250.050	10	2,5	25	50,0	9,5	10	108	3	▲
DSRA.3.100.250.053	10	2,5	50	53,0	9,5	10	108	3	▲
DSRA.3.100.250.070	10	2,5	50	70,0	9,5	10	120	3	▲
DSRA.3.120.010.030	12	0,1	30	36,0	11,5	12	82	3	▲
DSRA.3.120.010.050	12	0,1	30	60,0	11,5	12	108	3	▲
DSRA.3.120.010.053	12	0,1	60	63,6	11,5	12	108	3	▲
DSRA.3.120.010.070	12	0,1	60	84,0	11,5	12	140	3	▲
DSRA.3.120.050.030	12	0,5	30	36,0	11,5	12	82	3	▲
DSRA.3.120.050.050	12	0,5	30	60,0	11,5	12	108	3	▲
DSRA.3.120.050.053	12	0,5	60	63,6	11,5	12	108	3	▲
DSRA.3.120.050.070	12	0,5	60	84,0	11,5	12	140	3	▲
DSRA.3.120.100.030	12	1,0	30	36,0	11,5	12	82	3	▲
DSRA.3.120.100.050	12	1,0	30	60,0	11,5	12	108	3	▲
DSRA.3.120.100.053	12	1,0	60	63,6	11,5	12	108	3	▲
DSRA.3.120.100.070	12	1,0	60	84,0	11,5	12	140	3	▲
DSRA.3.120.250.030	12	2,5	30	36,0	11,5	12	82	3	▲
DSRA.3.120.250.050	12	2,5	30	60,0	11,5	12	108	3	▲
DSRA.3.120.250.053	12	2,5	60	63,6	11,5	12	108	3	▲
DSRA.3.120.250.070	12	2,5	60	84,0	11,5	12	140	3	▲

▲ ab Lager / on stock Δ 4 Wochen / 4 weeks x auf Anfrage / upon request

● empfohlen / recommended

o bedingt einsetzbar / alternative recommendation

- nicht geeignet / not suitable

■ unbeschichtete HM-Sorten / uncoated grades

■ beschichtete HM-Sorten / coated grades

■ bestückt/Cermet / brazed/Cermet

Abmessungen in mm

Dimensions in mm

P	-
M	-
K	-
N	•
S	-
H	-



HM-Sorten  
Carbide grades

# Schnittdaten DSRA Ø 10 - 12 mm

## Cutting Data DSRA Ø 10 - 12 mm

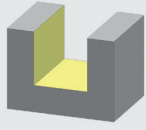
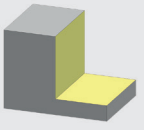

	 vc = m/min	 vc = m/min
N1.1	350	460
N1.2	370	480
N2.1	350	460
N2.2	300	390
N2.3	200	260
N3.1	250	330
N3.2	220	290
N4.1	250	330

d <sub>1</sub>							
		f <sub>z</sub>	a <sub>e</sub>	a <sub>p</sub>	f <sub>z</sub>	a <sub>e</sub>	a <sub>p</sub>
10	7°	0,044	10,00	15,00	0,033	2,00	25,00
10	5°	0,031	10,00	15,00	0,023	2,00	25,00
10	3°	0,031	10,00	15,00	0,023	2,00	50,00
10	3°	0,018	10,00	15,00	0,013	2,00	50,00
10	7°	0,044	10,00	15,00	0,033	2,00	25,00
10	5°	0,031	10,00	15,00	0,023	2,00	25,00
10	3°	0,031	10,00	15,00	0,023	2,00	50,00
10	3°	0,018	10,00	15,00	0,013	2,00	50,00
10	7°	0,044	10,00	15,00	0,033	2,00	25,00
10	5°	0,031	10,00	15,00	0,023	2,00	25,00
10	3°	0,031	10,00	15,00	0,023	2,00	50,00
10	3°	0,018	10,00	15,00	0,013	2,00	50,00
10	7°	0,044	10,00	15,00	0,033	2,00	25,00
10	5°	0,031	10,00	15,00	0,023	2,00	25,00
10	3°	0,031	10,00	15,00	0,023	2,00	50,00
10	3°	0,018	10,00	15,00	0,013	2,00	50,00
10	7°	0,044	10,00	15,00	0,033	2,00	25,00
10	5°	0,031	10,00	15,00	0,023	2,00	25,00
10	3°	0,031	10,00	15,00	0,023	2,00	50,00
10	3°	0,018	10,00	15,00	0,013	2,00	50,00
12	7°	0,054	12,00	18,00	0,042	2,40	30,00
12	5°	0,038	12,00	18,00	0,030	2,40	30,00
12	3°	0,038	12,00	18,00	0,030	2,40	60,00
12	3°	0,022	12,00	18,00	0,017	2,40	60,00
12	7°	0,054	12,00	18,00	0,042	2,40	30,00
12	5°	0,038	12,00	18,00	0,030	2,40	30,00
12	3°	0,038	12,00	18,00	0,030	2,40	60,00
12	3°	0,022	12,00	18,00	0,017	2,40	60,00
12	7°	0,054	12,00	18,00	0,042	2,40	30,00
12	5°	0,038	12,00	18,00	0,030	2,40	30,00
12	3°	0,038	12,00	18,00	0,030	2,40	60,00
12	3°	0,022	12,00	18,00	0,017	2,40	60,00
12	7°	0,054	12,00	18,00	0,042	2,40	30,00
12	5°	0,038	12,00	18,00	0,030	2,40	30,00
12	3°	0,038	12,00	18,00	0,030	2,40	60,00
12	3°	0,022	12,00	18,00	0,017	2,40	60,00

Abmessungen in mm  
Dimensions in mm

B



# Schaftfräser, Eckenradius

End Mill, corner radius



## DSRA

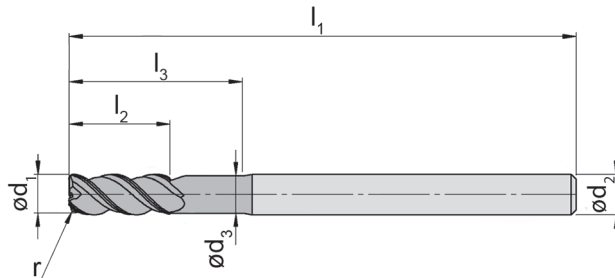
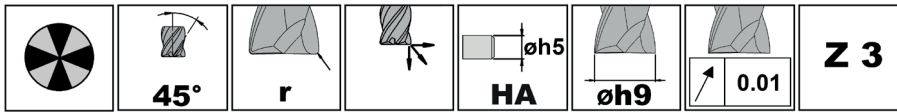

B

Bestellnummer Part number	d <sub>1</sub>	r	l <sub>2</sub>	l <sub>3</sub>	d <sub>3</sub>	d <sub>2</sub>	l <sub>1</sub>	Z	MG3K
DSRA.3.160.010.030	16	0,1	40	48,0	15	16	108	3	▲
DSRA.3.160.010.050	16	0,1	40	80,0	15	16	140	3	▲
DSRA.3.160.010.053	16	0,1	80	84,8	15	16	140	3	▲
DSRA.3.160.050.030	16	0,5	40	48,0	15	16	108	3	▲
DSRA.3.160.050.050	16	0,5	40	80,0	15	16	140	3	▲
DSRA.3.160.050.053	16	0,5	80	84,8	15	16	140	3	▲
DSRA.3.160.100.030	16	1,0	40	48,0	15	16	108	3	▲
DSRA.3.160.100.050	16	1,0	40	80,0	15	16	140	3	▲
DSRA.3.160.100.053	16	1,0	80	84,8	15	16	140	3	▲
DSRA.3.160.250.030	16	2,5	40	48,0	15	16	108	3	▲
DSRA.3.160.250.050	16	2,5	40	80,0	15	16	140	3	▲
DSRA.3.160.250.053	16	2,5	80	84,8	15	16	140	3	▲
DSRA.3.160.400.030	16	4,0	40	48,0	15	16	108	3	▲
DSRA.3.160.400.050	16	4,0	40	80,0	15	16	140	3	▲
DSRA.3.160.400.053	16	4,0	80	84,8	15	16	140	3	▲
DSRA.3.200.010.027	20	0,1	50	54,0	19	20	108	3	▲
DSRA.3.200.010.050	20	0,1	50	100,0	19	20	163	3	▲
DSRA.3.200.010.053	20	0,1	100	106,0	19	20	163	3	▲
DSRA.3.200.050.027	20	0,5	50	54,0	19	20	108	3	▲
DSRA.3.200.050.050	20	0,5	50	100,0	19	20	163	3	▲
DSRA.3.200.050.053	20	0,5	100	106,0	19	20	163	3	▲
DSRA.3.200.100.027	20	1,0	50	54,0	19	20	108	3	▲
DSRA.3.200.100.050	20	1,0	50	100,0	19	20	163	3	▲
DSRA.3.200.100.053	20	1,0	100	106,0	19	20	163	3	▲
DSRA.3.200.250.027	20	2,5	50	54,0	19	20	108	3	▲
DSRA.3.200.250.050	20	2,5	50	100,0	19	20	163	3	▲
DSRA.3.200.250.053	20	2,5	100	106,0	19	20	163	3	▲
DSRA.3.200.400.027	20	4,0	50	54,0	19	20	108	3	▲
DSRA.3.200.400.050	20	4,0	50	100,0	19	20	163	3	▲
DSRA.3.200.400.053	20	4,0	100	106,0	19	20	163	3	▲

▲ ab Lager / on stock Δ 4 Wochen / 4 weeks x auf Anfrage / upon request

● empfohlen / recommended

o bedingt einsetzbar / alternative recommendation

- nicht geeignet / not suitable

■ unbeschichtete HM-Sorten / uncoated grades

■ beschichtete HM-Sorten / coated grades

■ bestückt/Cermet / brazed/Cermet

Abmessungen in mm

Dimensions in mm

P	-
M	-
K	-
N	•
S	-
H	-



HM-Sorten  
Carbide grades

# Schnittdaten DSRA Ø 16 - 20 mm

## Cutting Data DSRA Ø 16 - 20 mm

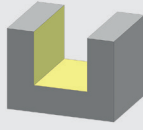
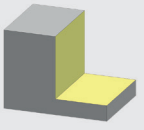

	 vc = m/min	 vc = m/min
N1.1	350	460
N1.2	370	480
N2.1	350	460
N2.2	300	390
N2.3	200	260
N3.1	250	330
N3.2	220	290
N4.1	250	330

d <sub>1</sub>							
		f <sub>z</sub>	a <sub>e</sub>	a <sub>p</sub>	f <sub>z</sub>	a <sub>e</sub>	a <sub>p</sub>
16	7°	0,074	16,00	24,00	0,060	3,20	40,00
16	5°	0,052	16,00	24,00	0,042	3,20	40,00
16	3°	0,052	16,00	24,00	0,042	3,20	80,00
16	3°	0,074	16,00	24,00	0,060	3,20	40,00
16	7°	0,052	16,00	24,00	0,042	3,20	40,00
16	5°	0,052	16,00	24,00	0,042	3,20	80,00
16	3°	0,074	16,00	24,00	0,060	3,20	40,00
16	3°	0,052	16,00	24,00	0,042	3,20	40,00
16	7°	0,052	16,00	24,00	0,042	3,20	80,00
16	5°	0,074	16,00	24,00	0,060	3,20	40,00
16	3°	0,052	16,00	24,00	0,042	3,20	40,00
16	3°	0,052	16,00	24,00	0,042	3,20	80,00
16	7°	0,074	16,00	24,00	0,060	3,20	40,00
16	5°	0,052	16,00	24,00	0,042	3,20	40,00
16	3°	0,052	16,00	24,00	0,042	3,20	80,00
20	3°	0,094	20,00	30,00	0,078	4,00	50,00
20	7°	0,066	20,00	30,00	0,055	4,00	50,00
20	5°	0,066	20,00	30,00	0,055	4,00	100,00
20	3°	0,094	20,00	30,00	0,078	4,00	50,00
20	3°	0,066	20,00	30,00	0,055	4,00	50,00
20	7°	0,066	20,00	30,00	0,055	4,00	100,00
20	5°	0,094	20,00	30,00	0,078	4,00	50,00
20	3°	0,066	20,00	30,00	0,055	4,00	50,00
20	3°	0,066	20,00	30,00	0,055	4,00	100,00
20	7°	0,094	20,00	30,00	0,078	4,00	50,00
20	5°	0,066	20,00	30,00	0,055	4,00	50,00
20	3°	0,066	20,00	30,00	0,055	4,00	100,00
20	3°	0,094	20,00	30,00	0,078	4,00	50,00
20	7°	0,066	20,00	30,00	0,055	4,00	50,00
20	5°	0,066	20,00	30,00	0,055	4,00	100,00

Abmessungen in mm  
Dimensions in mm

B

# Schaftfräser HPC, Eckfase

End Mill HPC, corner chamfer



## DSFA

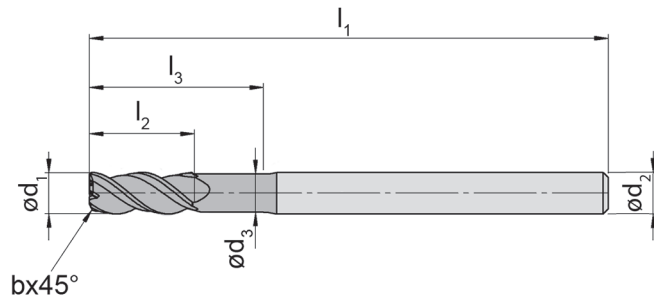
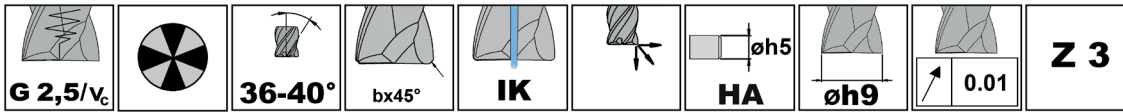

B

Bestellnummer Part number	d <sub>1</sub>	b	l <sub>2</sub>	l <sub>3</sub>	d <sub>3</sub>	d <sub>2</sub>	l <sub>1</sub>	Z	NE2K
DSFA.3.060.030	6	0,2	15	18,0	5,6	6	57	3	▲
DSFA.3.060.050	6	0,2	15	30,0	5,6	6	70	3	▲
DSFA.3.060.053	6	0,2	30	31,8	5,6	6	70	3	▲
DSFA.3.060.070	6	0,2	30	42,0	5,6	6	80	3	▲
DSFA.3.080.030	8	0,2	20	24,0	7,5	8	64	3	▲
DSFA.3.080.050	8	0,2	20	40,0	7,5	8	80	3	▲
DSFA.3.080.053	8	0,2	40	42,4	7,5	8	80	3	▲
DSFA.3.080.070	8	0,2	40	56,0	7,5	8	100	3	▲
DSFA.3.100.030	10	0,2	25	30,0	9,5	10	72	3	▲
DSFA.3.100.050	10	0,2	25	50,0	9,5	10	100	3	▲
DSFA.3.100.053	10	0,2	50	53,0	9,5	10	100	3	▲
DSFA.3.100.070	10	0,2	50	70,0	9,5	10	115	3	▲
DSFA.3.120.030	12	0,2	30	36,0	11,5	12	85	3	▲
DSFA.3.120.050	12	0,2	30	60,0	11,5	12	108	3	▲
DSFA.3.120.053	12	0,2	60	63,6	11,5	12	108	3	▲
DSFA.3.120.070	12	0,2	60	84,0	11,5	12	140	3	▲
DSFA.3.160.030	16	0,5	40	48,0	15,0	16	100	3	▲
DSFA.3.160.050	16	0,5	40	80,0	15,0	16	140	3	▲
DSFA.3.160.053	16	0,5	80	84,8	15,0	16	140	3	▲
DSFA.3.200.027	20	0,5	50	54,0	19,0	20	108	3	▲
DSFA.3.200.050	20	0,5	50	100,0	19,0	20	163	3	▲
DSFA.3.200.053	20	0,5	100	106,0	19,0	20	163	3	▲

▲ ab Lager / on stock Δ 4 Wochen / 4 weeks x auf Anfrage / upon request

● empfohlen / recommended

o bedingt einsetzbar / alternative recommendation

- nicht geeignet / not suitable

■ unbeschichtete HM-Sorten / uncoated grades

■ beschichtete HM-Sorten / coated grades

■ bestückt/Cermet / brazed/Cermet

Abmessungen in mm

Dimensions in mm

P	-
M	-
K	-
N	•
S	-
H	-



HM-Sorten  
Carbide grades

# Schnittdaten DSFA Ø 6 - 20 mm

## Cutting Data DSFA Ø 6 - 20 mm

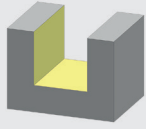
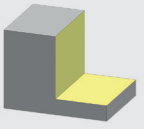

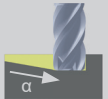
	 vc = m/min	 vc = m/min
N1.1	450	540
N1.2	500	600
N2.1	450	540
N2.2	350	420
N2.3	280	340
N3.1	300	360
N3.2	280	340
N4.1	300	360

d <sub>1</sub>							
		f <sub>z</sub>	a <sub>e</sub>	a <sub>p</sub>	f <sub>z</sub>	a <sub>e</sub>	a <sub>p</sub>
6	20°	0,026	6,00	9,00	0,047	1,20	15,00
6	10°	0,018	6,00	9,00	0,066	0,30	15,00
6	3°	0,018	6,00	9,00	0,066	0,30	30,00
6	3°	0,010	6,00	9,00	0,038	0,30	30,00
8	20°	0,035	8,00	12,00	0,128	0,40	20,00
8	10°	0,025	8,00	12,00	0,090	0,40	20,00
8	3°	0,025	8,00	12,00	0,090	0,40	40,00
8	3°	0,014	8,00	12,00	0,051	0,40	40,00
10	20°	0,044	10,00	15,00	0,161	0,50	25,00
10	10°	0,031	10,00	15,00	0,113	0,50	25,00
10	3°	0,031	10,00	15,00	0,113	0,50	50,00
10	3°	0,018	10,00	15,00	0,064	0,50	50,00
12	20°	0,054	12,00	18,00	0,194	0,60	30,00
12	10°	0,037	12,00	18,00	0,136	0,60	30,00
12	3°	0,037	12,00	18,00	0,136	0,60	60,00
12	3°	0,021	12,00	18,00	0,078	0,60	60,00
16	20°	0,072	16,00	24,00	0,260	0,80	40,00
16	10°	0,050	16,00	24,00	0,182	0,80	40,00
16	3°	0,050	16,00	24,00	0,182	0,80	80,00
20	20°	0,090	20,00	30,00	0,327	1,00	50,00
20	10°	0,063	20,00	30,00	0,229	1,00	50,00
20	3°	0,063	20,00	30,00	0,229	1,00	100,00

Abmessungen in mm  
Dimensions in mm



# Kordelschruppfräser

## Roughing End Mill with ripper profile



### DSFRA

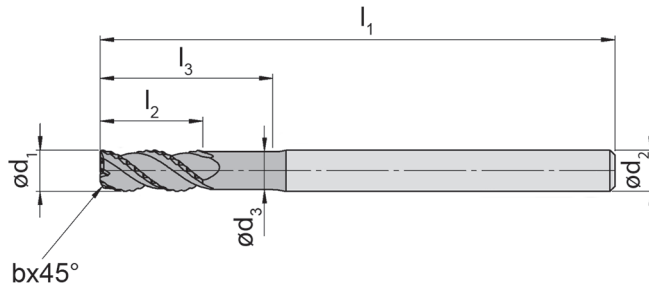
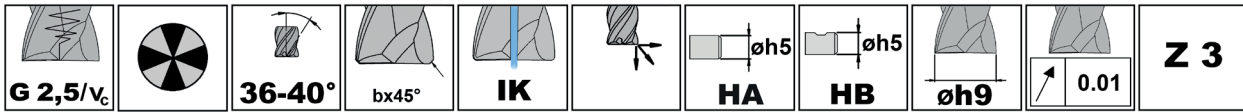

B

Bestellnummer Part number	d <sub>1</sub>	b	l <sub>2</sub>	l <sub>3</sub>	d <sub>3</sub>	d <sub>2</sub>	l <sub>1</sub>	Z	Ausführung Type	NEZK
DSFRA.3.060.030	6	0,4	15	18	5,6	6	57	3	HA	▲
DSFRA.3.060.050	6	0,4	15	30	5,6	6	70	3	HA	▲
DSFRA.3.080.030	8	0,5	20	24	7,5	8	64	3	HA	▲
DSFRA.3.080.050	8	0,5	20	40	7,5	8	80	3	HA	▲
DSFRA.3.100.030	10	0,5	25	30	9,5	10	72	3	HA	▲
DSFRA.3.100.050	10	0,5	25	50	9,5	10	100	3	HA	▲
DSFRA.3.120.030	12	0,5	30	36	11,5	12	85	3	HA	▲
DSFRA.3.120.030.B	12	0,5	30	36	11,5	12	85	3	HB	▲
DSFRA.3.120.050	12	0,5	30	60	11,5	12	108	3	HA	▲
DSFRA.3.120.050.B	12	0,5	30	60	11,5	12	108	3	HB	▲
DSFRA.3.160.030	16	0,6	40	48	15,0	16	100	3	HA	▲
DSFRA.3.160.030.B	16	0,6	40	48	15,0	16	100	3	HB	▲
DSFRA.3.160.050	16	0,6	40	80	15,0	16	140	3	HA	▲
DSFRA.3.160.050.B	16	0,6	40	80	15,0	16	140	3	HB	▲
DSFRA.3.200.027	20	0,8	50	54	18,8	20	108	3	HA	▲
DSFRA.3.200.027.B	20	0,8	50	54	18,8	20	108	3	HB	▲
DSFRA.3.200.050	20	0,8	50	100	18,8	20	163	3	HA	▲
DSFRA.3.200.050.B	20	0,8	50	100	18,8	20	163	3	HB	▲

▲ ab Lager / on stock Δ 4 Wochen / 4 weeks x auf Anfrage / upon request

● empfohlen / recommended

o bedingt einsetzbar / alternative recommendation

- nicht geeignet / not suitable

■ unbeschichtete HM-Sorten / uncoated grades

■ beschichtete HM-Sorten / coated grades

■ bestückt/Cermet / brazed/Cermet

Abmessungen in mm

Dimensions in mm

P	-
M	-
K	-
N	•
S	-
H	-



HM-Sorten  
Carbide grades

# Schnittdaten DSFRA Ø 6 - 20 mm

## Cutting Data DSFRA Ø 6 - 20 mm

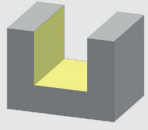
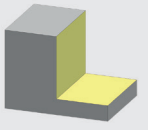

	 vc = m/min	 vc = m/min
N1.1	450	540
N1.2	500	600
N2.1	450	540
N2.2	350	420
N2.3	280	340
N3.1	300	360
N3.2	280	340
N4.1	300	360

d <sub>1</sub>							
		f <sub>z</sub>	a <sub>e</sub>	a <sub>p</sub>	f <sub>z</sub>	a <sub>e</sub>	a <sub>p</sub>
6	20°	0,030	6,00	9,00	0,062	2,40	15,00
6	10°	0,021	6,00	9,00	0,043	2,40	15,00
8	20°	0,041	8,00	12,00	0,083	3,20	20,00
8	10°	0,029	8,00	12,00	0,058	3,20	20,00
10	20°	0,053	10,00	15,00	0,104	4,00	25,00
10	10°	0,037	10,00	15,00	0,073	4,00	25,00
12	20°	0,064	12,00	18,00	0,125	4,80	30,00
12	20°	0,064	12,00	18,00	0,125	4,80	30,00
12	10°	0,045	12,00	18,00	0,087	4,80	30,00
12	10°	0,045	12,00	18,00	0,087	4,80	30,00
16	20°	0,086	16,00	24,00	0,167	6,40	40,00
16	20°	0,086	16,00	24,00	0,167	6,40	40,00
16	10°	0,060	16,00	24,00	0,117	6,40	40,00
16	10°	0,060	16,00	24,00	0,117	6,40	40,00
20	20°	0,108	20,00	30,00	0,209	8,00	50,00
20	20°	0,108	20,00	30,00	0,209	8,00	50,00
20	10°	0,076	20,00	30,00	0,146	8,00	50,00
20	10°	0,076	20,00	30,00	0,146	8,00	50,00

Abmessungen in mm  
Dimensions in mm



B



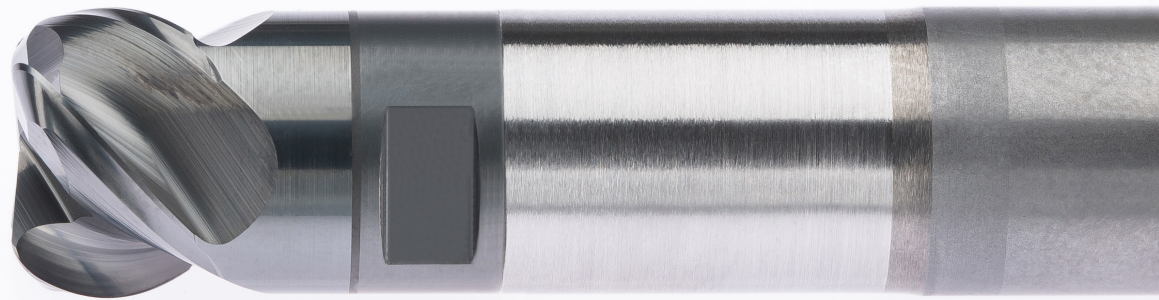

## **Frässystem DG**

für

- Bohrnutenfräsen
- Fasen und Anbohren
- Kopierfräsen
- Hochvorschubsfräsen
- Verzahnungsfräsen

## **Milling system DG**

for

- Centre Cutting and Groove Milling
- Chamfering and Centering
- Copy Milling
- High Feed Milling
- Gear Milling



C

Fräuserschaft  
Milling shank  
MDG

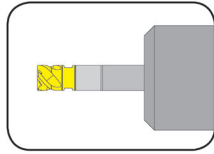

Seite/Page  
C3-C6

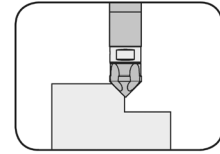

Seite/Page  
C24

Schneidplatte  
Insert  
DGR

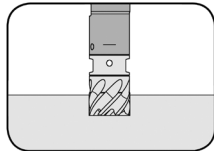

Seite/Page  
C8

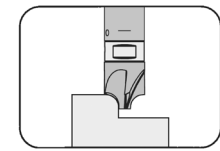

Seite/Page  
C26

Schneidkopf  
Cutter Head  
DGR/DGF/DGRR/  
DGH/DGM/DGK/  
DGVZ/DGFF/DGV

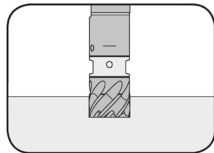

Seite/Page  
C10, C12

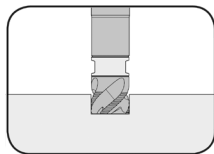

Seite/Page  
C14

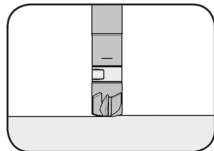

Seite/Page  
C16

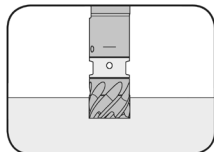

Seite/Page  
C18

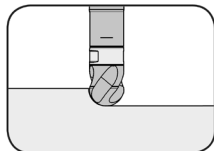

Seite/Page  
C20

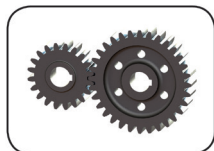

Seite/Page  
C22

# Nutfräsen

## Groove milling



### Frälerschaft

#### Milling shank

### MDG

mit innerer Kühlmittelzufuhr  
with through coolant supply

90° Aufnahmeschaft - schrumpfbar  
Shank 90° - shrink fit

Schaftmaterial: Hartmetall  
Material of shank: Carbide

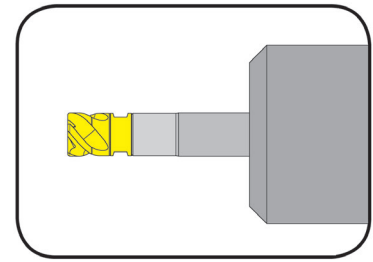

C

Schneidkopf  
Cutter Head

Typ DGK  
Type DGM  
DGF  
DGR  
DGRR  
DGFF  
DGH  
DGV  
DGVZ

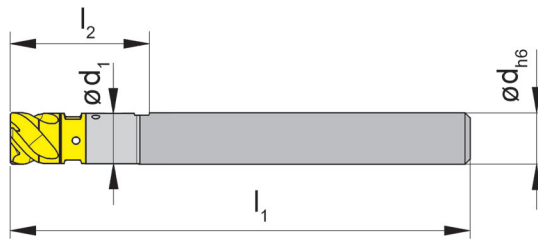

Bestellnummer Part number	d	l <sub>1</sub>	l <sub>2</sub>	d <sub>1</sub>	System System
MDG.10.0010.90.00.A	10	72,8	30,0	9,8	DG10
MDG.10.0010.90.01.A	10	101,8	56,8	9,8	DG10
MDG.12.0012.90.00.A	12	83,3	36,0	11,7	DG12
MDG.12.0012.90.01.A	12	114,3	59,3	11,7	DG12
MDG.16.0016.90.00.A	16	98,8	48,0	15,6	DG16
MDG.16.0016.90.01.A	16	129,8	64,8	15,6	DG16
MDG.20.0020.90.00.A	20	112,3	60,0	19,5	DG20
MDG.20.0020.90.01.A	20	150,3	70,3	19,5	DG20

Weitere Abmessungen auf Anfrage  
Further sizes upon request

Abmessungen in mm  
Dimensions in mm

Bei Frälerschäften MDG10... ist das Gewinde **NICHT** segmentiert!  
For toolholders MDG10... Please note the threads are **NOT** segmented.

#### Ersatzteile

Schlüssel und Zubehör sind nicht im Lieferumfang enthalten - bitte separat bestellen. Details und erforderliche Anzugsmomente finden Sie in den Technischen Daten auf Seite C7.

#### Spare Parts

Wrenches and additional equipment are not combined with the milling shank. Separate order required! For more details and torque specifications please see the technical data on page C7.

Frälerschäfte mit beschädigter Schneidkopfaufnahme können durch unseren Reparaturservice instand gesetzt werden.  
Milling cutter shanks with damaged seating can be repaired by HORN.

# Nutfräsen

## Groove milling



### Frälerschaft

#### Milling shank

## MDG

ohne Kühlmittelzufuhr  
no coolant supply

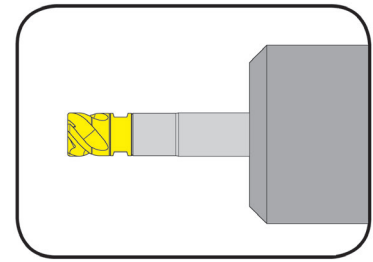

90° Aufnahmeschaft - nicht schrumpfbar  
Shank 90° - not recommended for shrinking

Schaftmaterial: Stahl  
Material of shank: Steel

Schneidkopf  
Cutter Head

Typ DGK  
Type DGM  
DGF  
DGR  
DGRR  
DGFF  
DGH  
DGV  
DGVZ

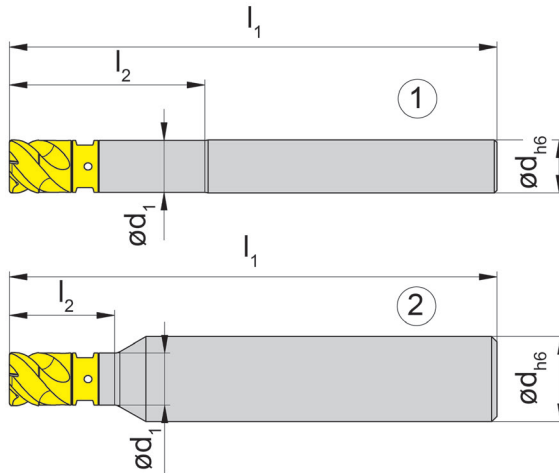

Bestellnummer Part number	d	l <sub>1</sub>	l <sub>2</sub>	d <sub>1</sub>	Form Form
MDG.10.ST10.90.01.A	10	91,8	36,8	9,8	1
MDG.10.ST16.90.01.A	16	91,8	19,8	9,8	2
MDG.12.ST12.90.01.A	12	109,3	44,3	11,7	1
MDG.12.ST16.90.01.A	16	99,3	22,3	11,7	2
MDG.16.ST16.90.01.A	16	134,8	49,8	15,6	1
MDG.16.ST20.90.01.A	20	104,8	27,8	15,6	2
MDG.20.ST20.90.01.A	20	150,3	60,3	19,5	1
MDG.20.ST25.90.01.A	25	110,3	33,3	19,5	2

Weitere Abmessungen auf Anfrage  
Further sizes upon request

Abmessungen in mm  
Dimensions in mm

Bei Frälerschäften MDG10... ist das Gewinde **NICHT** segmentiert!  
For toolholders MDG10... Please note the threads are **NOT** segmented.

#### Ersatzteile

Schlüssel und Zubehör sind nicht im Lieferumfang enthalten - bitte separat bestellen. Details und erforderliche Anzugsmomente finden Sie in den Technischen Daten auf Seite C7.

#### Spare Parts

Wrenches and additional equipment are not combined with the milling shank. Separate order required! For more details and torque specifications please see the technical data on page C7.

Frälerschäfte mit beschädigter Schneidkopfaufnahme können durch unseren Reparaturservice instand gesetzt werden.  
Milling cutter shanks with damaged seating can be repaired by HORN.

# Nutfräsen

## Groove milling



### Frälerschaft

#### Milling shank

## MDG

mit innerer Kühlmittelzufuhr  
with through coolant supply

87° Aufnahmeschaft - schrumpfbar  
Shank 87° - shrink fit

Schaftmaterial: Hartmetall  
Material of shank: Carbide

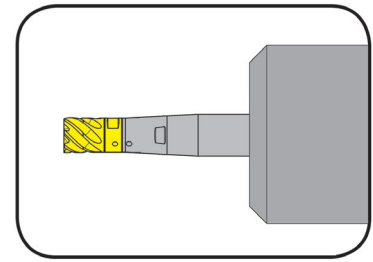

C

Schneidkopf  
Cutter Head

Typ DGK  
Type DGM  
DGF  
DGR  
DGRR  
DGFF  
DGH  
DGV  
DGVZ

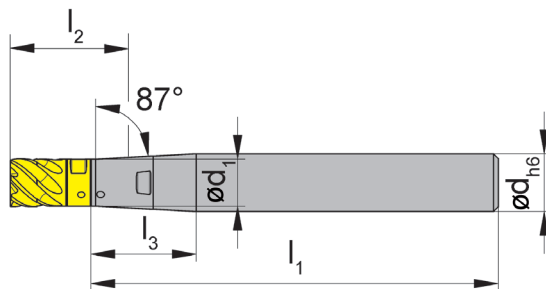

Bestellnummer Part number	d	l <sub>1</sub>	l <sub>2</sub>	d <sub>1</sub>	l <sub>3</sub>
<b>MDG.10.0012.87.01.A</b>	12	85	19,7	9,8	22
<b>MDG.12.0016.87.01.A</b>	16	100	23,1	11,7	42
<b>MDG.16.0020.87.01.A</b>	20	100	29,6	15,6	43

Weitere Abmessungen auf Anfrage  
Further sizes upon request

Abmessungen in mm  
Dimensions in mm

Bei Frälerschäften MDG10... ist das Gewinde **NICHT** segmentiert!  
For toolholders MDG10... Please note the threads are **NOT** segmented.

#### Ersatzteile

Schlüssel und Zubehör sind nicht im Lieferumfang enthalten - bitte separat bestellen. Details und erforderliche Anzugsmomente finden Sie in den Technischen Daten auf Seite C7.

#### Spare Parts

Wrenches and additional equipment are not combined with the milling shank. Separate order required! For more details and torque specifications please see the technical data on page C7.

Frälerschäfte mit beschädigter Schneidkopfaufnahme können durch unseren Reparaturservice instand gesetzt werden.  
Milling cutter shanks with damaged seating can be repaired by HORN.

# Nutfräsen

## Groove milling



### Frälerschaft

#### Milling shank

### MDG

mit innerer Kühlmittelzufuhr  
with through coolant supply

89° Aufnahmeschaft - schrumpfbar  
Shank 89° - shrink fit

Schaftmaterial: Hartmetall  
Material of shank: Carbide

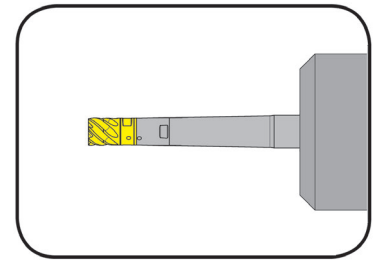

Schneidkopf  
Cutter Head

Typ DGK  
Type DGM  
DGF  
DGR  
DGRR  
DGFF  
DGH  
DGV  
DGVZ

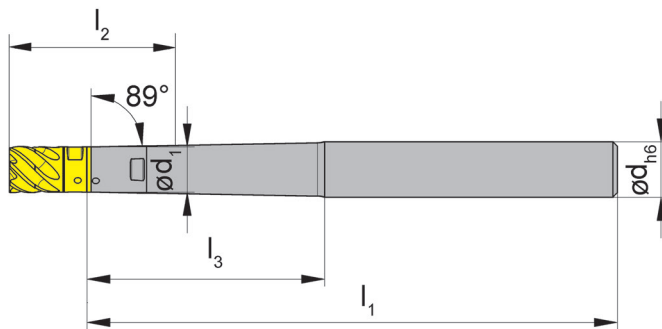

Bestellnummer Part number	d	l <sub>1</sub>	l <sub>2</sub>	d <sub>1</sub>	l <sub>3</sub>
<b>MDG.10.0012.89.01.A</b>	12	115	23,5	9,8	50
<b>MDG.12.0016.89.01.A</b>	16	140	28,8	11,7	75
<b>MDG.16.0020.89.01.A</b>	20	160	37,2	15,6	75

Weitere Abmessungen auf Anfrage  
Further sizes upon request

Abmessungen in mm  
Dimensions in mm

Bei Frälerschäften MDG10... ist das Gewinde **NICHT** segmentiert!  
For toolholders MDG10... Please note the threads are **NOT** segmented.

#### Ersatzteile

Schlüssel und Zubehör sind nicht im Lieferumfang enthalten - bitte separat bestellen. Details und erforderliche Anzugsmomente finden Sie in den Technischen Daten auf Seite C7.

#### Spare Parts

Wrenches and additional equipment are not combined with the milling shank. Separate order required! For more details and torque specifications please see the technical data on page C7.

Frälerschäfte mit beschädigter Schneidkopfaufnahme können durch unseren Reparaturservice instand gesetzt werden.  
Milling cutter shanks with damaged seating can be repaired by HORN.

### Anzugsmoment Torque for setting

System System	Anzugsmoment (Nm) Torque for setting (Nm)	Schlüsselweite Wrench size <b>SW</b>	Maulschlüssel Combination wrench	Drehmomentschlüssel Torque wrench		
				Einsatz Application	Messbereich Effective range	für Kleinserien for small series
<b>DG10</b>	10	<b>8</b>	S.DG1012	D.DG1001	D0525VK 5 - 25 Nm	D1050VK 10 - 50 Nm
<b>DG12</b>	14	<b>10</b>		D.DG1201		
<b>DG16</b>	25	<b>13</b>	S.DG1620	D.DG1601	D20100VK 20 - 100 Nm	
<b>DG20</b>	35	<b>17</b>		D.DG2001		

### Montageanleitung

1. Reinigen Sie die Schnittstelle und Plananlage am Fräuserschaft und am Schneideinsatz
2. Spannen Sie den Fräuserschaft in der Aufnahme
3. Tragen Sie Schmierstoff im Bereich des Gewindes und der Kegel- und Plananlage des Schneideinsatzes auf
4. Fügen Sie den Schneideinsatz gemäß Markierung in den Schaft und drehen Sie von Hand an -  
**Vorsicht Verletzungsgefahr!**
5. Ziehen Sie den Schneideinsatz im Fräuserschaft mit dem entsprechenden Drehmoment mit Hilfe eines Drehmomentschlüssels an.

### Hinweise:

Die Verwendung von Schmierstoff reduziert die Reibung zwischen Schneideinsatz und Halter. Die Sauberkeit der Schnittstellen ist sehr wichtig für eine hohe Rund- und Planlaufgenauigkeit. Das Anziehen der Schneideinsätze mit dem vorgeschriebenen Drehmoment stellt die Plananlage in der Schnittstelle sicher.

### Assembly instruction

1. Remove any dirt from the interface and seating surface of the milling cutter shank and cutting insert.
2. Grip milling cutter shank in jig.
3. Apply lubricant sparingly to thread, taper and seat surface of cutting insert.
4. Insert cutting insert into shank and clamp it manually according to mark.  
**Attention: risk of injury!**
5. Tighten cutting insert in milling cutter shank with a torque wrench, using the recommended torque.

### Note:

The use of lubricant reduces friction between cutting insert and tool holder. For optimum radial and axial run-out precision it is crucial that interfaces and seat surfaces are clean. Applying the recommended tightening torque for gripping cutting inserts guarantees the correct insert fit.



### Schneidkopf

#### Cutter Head

## DGR...IK

mit innerer Kühlmittelzufuhr  
with through coolant supply

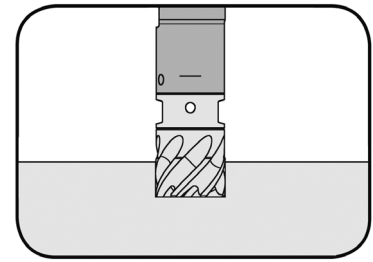

Schneidkopf mit Eckenradius  
Cutter head with corner radius

für Frälerschaft  
for Milling shank

Typ MDG  
Type

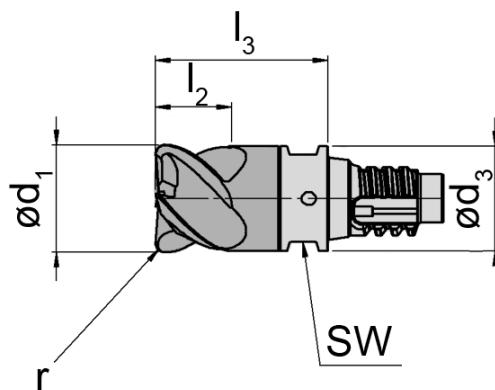

Stirnschneide nicht über  
Mitte schneidend  
face cutting edge not cutting  
across centre

Abbildung = rechtsschneidend  
Picture = right hand cutting version

Bestellnummer Part number	System System	SW	Z	d <sub>1</sub>	d <sub>3</sub>	r	l <sub>3</sub>	l <sub>2</sub>	AN2P
DGR.3.10.1000.05.IK	DG10	8	3	10	9,8	0,5	16,8	5,5	▲
DGR.3.10.1000.10.IK	DG10	8	3	10	9,8	1,0	16,8	5,5	▲
DGR.4.10.1000.05.IK	DG10	8	4	10	9,8	0,5	16,8	5,5	▲
DGR.4.10.1000.10.IK	DG10	8	4	10	9,8	1,0	16,8	5,5	▲
DGR.3.12.1200.05.IK	DG12	10	3	12	11,7	0,5	19,3	6,5	▲
DGR.4.12.1200.05.IK	DG12	10	4	12	11,7	0,5	19,3	6,5	▲
DGR.4.12.1200.10.IK	DG12	10	4	12	11,7	1,0	19,3	6,5	▲
DGR.5.16.1600.05.IK	DG16	13	5	16	15,6	0,5	24,8	8,5	▲
DGR.5.16.1600.10.IK	DG16	13	5	16	15,6	1,0	24,8	8,5	▲
DGR.5.16.1600.15.IK	DG16	13	5	16	15,6	1,5	24,8	8,5	▲
DGR.5.16.1600.20.IK	DG16	13	5	16	15,6	2,0	24,8	8,5	▲

▲ ab Lager / on stock Δ 4 Wochen / 4 weeks x auf Anfrage / upon request

● empfohlen / recommended

o bedingt einsetzbar / alternative recommendation

- nicht geeignet / not suitable

■ unbeschichtete HM-Sorten / uncoated grades

■ beschichtete HM-Sorten / coated grades



■ bestückt/Cermet / brazed/Cermet

Abmessungen in mm

Dimensions in mm



P	•
M	•
K	•
N	-
S	•
H	o

HM-Sorten  
Carbide grades

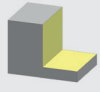
	 $vc = m/min$	 $vc = m/min$
P1.1	150	180
P1.2	150	180
P1.3	140	170
P2.1	130	160
P2.2	130	160
P2.3	130	160
P3.1	110	130
P3.2	100	120
M1.1	90	110
M2.1	70	80
M3.1	60	70

	 $vc = m/min$	 $vc = m/min$
K1.1	130	160
K1.2	110	130
K2.1	110	130
K2.2	100	120
K3.1	80	100
K3.2	70	80
S1.1	65	80
S2.1	45	50
S3.1	35	40
-	-	-
-	-	-



$d_1$							
		$f_z$	$a_e$	$a_p$	$f_z$	$a_e$	$a_p$
10	5°	0,05	10	5	0,07	4	5
10	5°	0,05	10	5	0,07	4	5
10	4°	0,05	10	5	0,06	4	5
10	4°	0,05	10	5	0,06	4	5
12	5°	0,06	12	6	0,09	5	6
12	4°	0,06	12	6	0,08	5	6
12	4°	0,06	12	6	0,08	5	6
16	3°	0,08	16	8	0,11	6	8
16	3°	0,08	16	8	0,11	6	8
16	3°	0,08	16	8	0,11	6	8
16	3°	0,08	16	8	0,11	6	8

Abmessungen in mm  
Dimensions in mm



### Schneidkopf

#### Cutter Head

## DGR

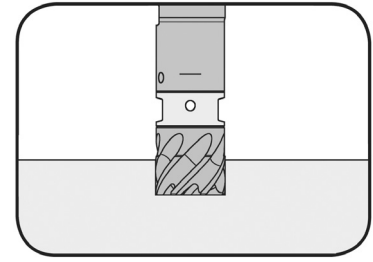

Schneidkopf mit Eckenradius  
Cutter head with corner radius

für Fräseschaft  
for Milling shank

Typ MDG  
Type

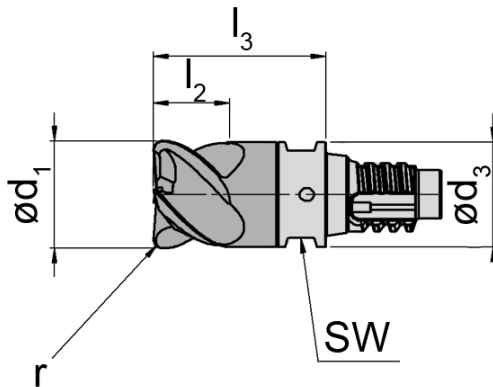

Stirnschneide über Mitte  
schneidend  
face cutting edge cutting  
across centre

Abbildung = rechtsschneidend  
Picture = right hand cutting version



Bestellnummer Part number	System System	SW	Z	d <sub>1</sub>	d <sub>3</sub>	r	l <sub>3</sub>	l <sub>2</sub>	AN2P
DGR.3.10.1000.05.00	DG10	8	3	10	9,8	0,5	16,8	5,5	▲
DGR.3.10.1000.10.00	DG10	8	3	10	9,8	1,0	16,8	5,5	▲
DGR.4.10.1000.05.00	DG10	8	4	10	9,8	0,5	16,8	5,5	▲
DGR.4.10.1000.10.00	DG10	8	4	10	9,8	1,0	16,8	5,5	▲
DGR.3.12.1200.05.00	DG12	10	3	12	11,7	0,5	19,3	6,5	▲
DGR.4.12.1200.05.00	DG12	10	4	12	11,7	0,5	19,3	6,5	▲
DGR.4.12.1200.10.00	DG12	10	4	12	11,7	1,0	19,3	6,5	▲
DGR.5.16.1600.05.00	DG16	13	5	16	15,6	0,5	24,8	8,5	▲
DGR.5.16.1600.10.00	DG16	13	5	16	15,6	1,0	24,8	8,5	▲
DGR.5.16.1600.15.00	DG16	13	5	16	15,6	1,5	24,8	8,5	▲
DGR.5.16.1600.20.00	DG16	13	5	16	15,6	2,0	24,8	8,5	▲
DGR.5.20.2000.05.00	DG20	17	5	20	19,5	0,5	30,3	12,0	▲
DGR.5.20.2000.10.00	DG20	17	5	20	19,5	1,0	30,3	12,0	▲
DGR.5.20.2000.15.00	DG20	17	5	20	19,5	1,5	30,3	12,0	▲
DGR.5.20.2000.20.00	DG20	17	5	20	19,5	2,0	30,3	12,0	▲

- ▲ ab Lager / on stock   Δ 4 Wochen / 4 weeks   x auf Anfrage / upon request
- empfohlen / recommended
- o bedingt einsetzbar / alternative recommendation
- nicht geeignet / not suitable
- unbeschichtete HM-Sorten / uncoated grades
- beschichtete HM-Sorten / coated grades
- bestückt/Cermet / brazed/Cermet



Abmessungen in mm  
Dimensions in mm

P	•
M	•
K	•
N	-
S	•
H	o

HM-Sorten  
Carbide grades

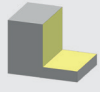
	 <b>vc = m/min</b>	 <b>vc = m/min</b>
<b>P1.1</b>	150	180
<b>P1.2</b>	150	180
<b>P1.3</b>	140	170
<b>P2.1</b>	130	160
<b>P2.2</b>	130	160
<b>P2.3</b>	130	160
<b>P3.1</b>	110	130
<b>P3.2</b>	100	120
<b>M1.1</b>	90	110
<b>M2.1</b>	70	80
<b>M3.1</b>	60	70

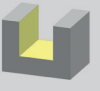
	 <b>vc = m/min</b>	 <b>vc = m/min</b>
<b>K1.1</b>	130	160
<b>K1.2</b>	110	130
<b>K2.1</b>	110	130
<b>K2.2</b>	100	120
<b>K3.1</b>	80	100
<b>K3.2</b>	70	80
<b>S1.1</b>	65	80
<b>S2.1</b>	45	50
<b>S3.1</b>	35	40
-	-	-
-	-	-

$d_1$							
		$f_z$	$a_e$	$a_p$	$f_z$	$a_e$	$a_p$
10	5°	0,04	10	5	0,07	4	5
10	5°	0,04	10	5	0,07	4	5
10	4°	0,04	10	5	0,06	4	5
10	4°	0,04	10	5	0,06	4	5
12	5°	0,05	12	6	0,09	5	6
12	4°	0,05	12	6	0,08	5	6
12	4°	0,05	12	6	0,08	5	6
16	3°	0,07	16	8	0,11	6	8
16	3°	0,07	16	8	0,11	6	8
16	3°	0,07	16	8	0,11	6	8
16	3°	0,07	16	8	0,11	6	8
20	3°	0,09	20	10	0,14	8	10
20	3°	0,09	20	10	0,14	8	10
20	3°	0,09	20	10	0,14	8	10
20	3°	0,09	20	10	0,14	8	10

Abmessungen in mm  
Dimensions in mm

C

### Schneidkopf

#### Cutter Head

## DGF

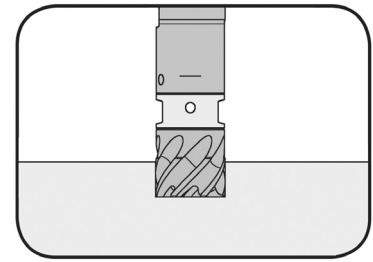

Schneidkopf mit Eckfase  
Cutter head with corner chamfer

für Fräseschaft  
for Milling shank

Typ MDG  
Type

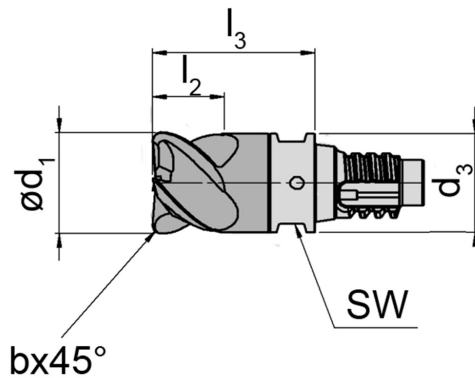

Stirnschneide über Mitte  
schneidend  
face cutting edge cutting  
across centre

Abbildung = rechtsschneidend  
Picture = right hand cutting version

Bestellnummer Part number	System System	SW	Z	d <sub>1</sub>	d <sub>3</sub>	l <sub>3</sub>	l <sub>2</sub>	b	AN2P
DGF.3.10.1000.02.00	DG10	8	3	10	9,8	16,8	5,5	0,20	▲
DGF.3.12.1200.02.00	DG12	10	3	12	11,7	19,3	6,5	0,20	▲
DGF.4.16.1600.02.00	DG16	13	4	16	15,6	24,8	8,5	0,20	▲
DGF.4.20.2000.03.00	DG20	17	4	20	19,5	30,3	12,0	0,25	▲

▲ ab Lager / on stock Δ 4 Wochen / 4 weeks x auf Anfrage / upon request

● empfohlen / recommended

o bedingt einsetzbar / alternative recommendation

- nicht geeignet / not suitable

□ unbeschichtete HM-Sorten / uncoated grades

■ beschichtete HM-Sorten / coated grades

■ bestückt/Cermet / brazed/Cermet

Abmessungen in mm

Dimensions in mm

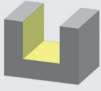
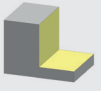

P	•
M	•
K	•
N	-
S	•
H	○

HM-Sorten  
Carbide grades

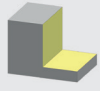
	 $vc = m/min$	 $vc = m/min$
P1.1	140	170
P1.2	140	170
P1.3	130	160
P2.1	120	140
P2.2	120	140
P2.3	120	140
P3.1	100	120
P3.2	90	110
M1.1	80	100
M2.1	60	70
M3.1	50	60

	 $vc = m/min$	 $vc = m/min$
K1.1	120	140
K1.2	100	120
K2.1	100	120
K2.2	90	110
K3.1	70	80
K3.2	60	70
S1.1	55	70
S2.1	40	50
S3.1	30	40
-	-	-
-	-	-

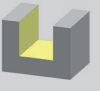

$d_1$							
		$f_z$	$a_e$	$a_p$	$f_z$	$a_e$	$a_p$
10	5°	0,04	10	5	0,07	4	5
12	5°	0,05	12	6	0,09	5	6
16	4°	0,07	16	8	0,11	6	8
20	4°	0,09	20	10	0,14	8	10

Abmessungen in mm  
Dimensions in mm

# Schruppfräser

## Roughing End Mill



### Schneidkopf

#### Cutter Head

## DGRR

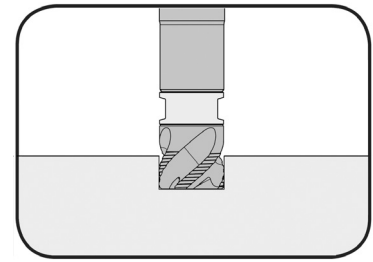

Schneidkopf mit Eckfase  
Cutter head with corner chamfer

für Fräseschaft  
for Milling shank

Typ MDG  
Type

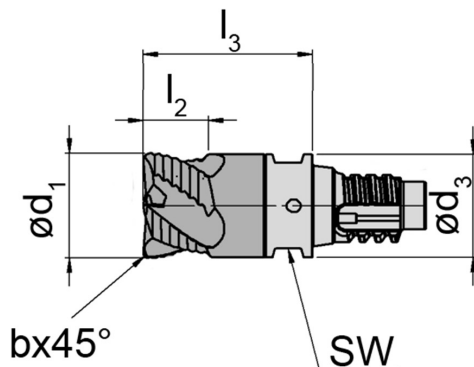

Stirnschneide über Mitte  
schneidend  
face cutting edge cutting  
across centre

Abbildung = rechtsschneidend  
Picture = right hand cutting version

Bestellnummer Part number	System System	SW	Z	d <sub>1</sub>	d <sub>3</sub>	l <sub>3</sub>	l <sub>2</sub>	b	AN2P
DGRR.3.10.1000.00	DG10	8	3	10	9,8	16,8	5,5	0,3	▲
DGRR.4.10.1000.00	DG10	8	4	10	9,8	16,8	5,5	0,3	▲
DGRR.3.12.1200.00	DG12	10	3	12	11,7	19,3	6,5	0,5	▲
DGRR.4.12.1200.00	DG12	10	4	12	11,7	19,3	6,5	0,5	▲
DGRR.5.16.1600.00	DG16	13	5	16	15,6	24,8	8,5	0,5	▲
DGRR.5.20.2000.00	DG20	17	5	20	19,5	30,3	12,0	0,5	▲

▲ ab Lager / on stock Δ 4 Wochen / 4 weeks x auf Anfrage / upon request

● empfohlen / recommended

o bedingt einsetzbar / alternative recommendation

- nicht geeignet / not suitable

■ unbeschichtete HM-Sorten / uncoated grades

■ beschichtete HM-Sorten / coated grades

■ bestückt/Cermet / brazed/Cermet

Abmessungen in mm

Dimensions in mm

P	●
M	●
K	●
N	-
S	●
H	○

HM-Sorten  
Carbide grades



# Schnittdaten DGRR

## Cutting Data DGRR

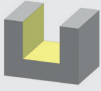
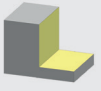

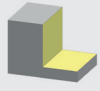
	 vc = m/min	 vc = m/min
P1.1	120	140
P1.2	120	140
P1.3	110	130
P2.1	110	130
P2.2	110	130
P2.3	110	130
P3.1	100	120
P3.2	100	120
M1.1	70	80
M2.1	60	70
M3.1	50	60

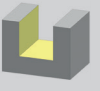
	 vc = m/min	 vc = m/min
K1.1	110	130
K1.2	100	120
K2.1	100	120
K2.2	80	100
K3.1	60	70
K3.2	60	70
S1.1	50	60
S2.1	40	50
S3.1	30	40
-	-	-
-	-	-

$d_1$							
		$f_z$	$a_e$	$a_p$	$f_z$	$a_e$	$a_p$
10	5°	0,06	10	5	0,07	8	5
10	4°	0,05	10	5	0,06	8	5
12	3°	0,06	12	6	0,07	9	6
12	3°	0,06	12	6	0,07	9	6
16	3°	0,09	16	8	0,10	12	8
20	3°	0,11	20	10	0,13	15	10

Abmessungen in mm  
Dimensions in mm

C

### Schneidkopf

#### Cutter Head

## DGH

Schneidkopf mit Eckenradius  
Cutter head with corner radius

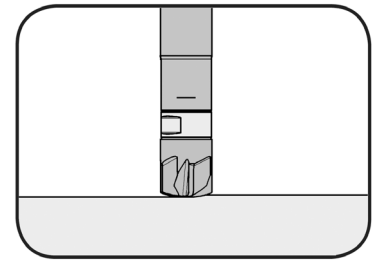

für Fräseschaft  
for Milling shank

Typ MDG  
Type



Abbildung = rechtsschneidend  
Picture = right hand cutting version

Stirnschneide nicht über  
Mitte schneidend  
face cutting edge not cutting  
across centre

Bestellnummer Part number	System System	SW	Z	d <sub>1</sub>	d <sub>3</sub>	l <sub>3</sub>	l <sub>2</sub>	r <sub>theo</sub>		AN2P
DGH.4.10.1000.00	DG10	8	4	10	9,8	16,8	0,7	1,07		▲
DGH.4.12.1200.00	DG12	10	4	12	11,7	19,3	0,8	1,18		▲
DGH.4.16.1600.00	DG16	13	4	16	15,6	24,8	1,0	1,38		▲
DGH.4.20.2000.00	DG20	17	4	20	19,5	30,3	1,2	1,96		▲

▲ ab Lager / on stock Δ 4 Wochen / 4 weeks x auf Anfrage / upon request

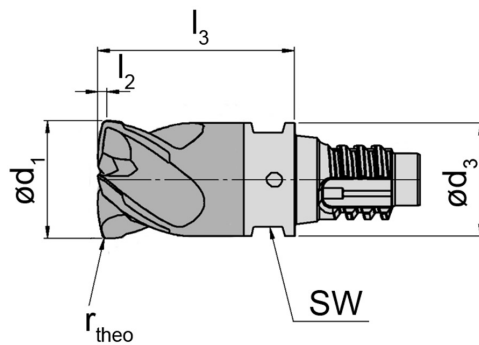
● empfohlen / recommended

o bedingt einsetzbar / alternative recommendation

- nicht geeignet / not suitable

■ unbeschichtete HM-Sorten / uncoated grades

■ beschichtete HM-Sorten / coated grades

■ bestückt/Cermet / brazed/Cermet

Abmessungen in mm

Dimensions in mm

P	●
M	●
K	●
N	-
S	●
H	○

HM-Sorten  
Carbide grades

# Schnittdaten DGH



## Cutting Data DGH

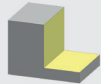
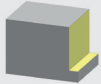

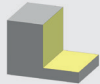
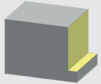
	 vc = m/min	 vc = m/min
P1.1	160	190
P1.2	160	190
P1.3	160	190
P2.1	150	180
P2.2	140	170
P2.3	140	170
P3.1	130	160
P3.2	130	160
M1.1	110	130
M2.1	100	120
M3.1	90	110

	 vc = m/min	 vc = m/min
K1.1	130	160
K1.2	130	160
K2.1	120	140
K2.2	120	140
K3.1	110	130
K3.2	110	130
S1	90	110
S2	70	80
S3	60	70
-	-	-
-	-	-



$d_1$							
		$f_z$	$a_e$	$a_p$	$f_z$	$a_e$	$a_p$
10	4°	0,39	10	0,4	0,59	7	0,6
12	4°	0,47	12	0,5	0,71	8	0,7
16	4°	0,63	16	0,6	0,94	11	0,9
20	4°	0,79	20	0,8	1,18	14	1,1

Abmessungen in mm  
Dimensions in mm



### Schneidkopf

#### Cutter Head

## DGM

mehrschneidig  
multiple fluted

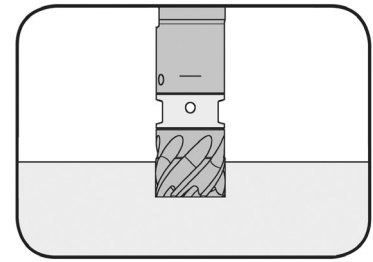

für Fräseschaft  
for Milling shank

Typ MDG  
Type



Abbildung = rechtsschneidend  
Picture = right hand cutting version

Stirnschneide nicht über  
Mitte schneidend  
face cutting edge not cutting  
across centre

Bestellnummer Part number	System System	SW	Z	d <sub>1</sub>	d <sub>3</sub>	r	l <sub>3</sub>	l <sub>2</sub>	AN2P
DGM.7.10.1000.02.0	DG10	8	7	10	9,8	0,2	16,8	5,5	▲
DGM.7.10.1000.10.0	DG10	8	7	10	9,8	1,0	16,8	5,5	▲
DGM.7.12.1200.02.0	DG12	10	7	12	11,7	0,2	19,3	6,5	▲
DGM.7.12.1200.10.0	DG12	10	7	12	11,7	1,0	19,3	6,5	▲
DGM.9.16.1600.02.0	DG16	13	9	16	15,6	0,2	24,8	9,0	▲
DGM.9.16.1600.10.0	DG16	13	9	16	15,6	1,0	24,8	9,0	▲
DGM.9.20.2000.02.0	DG20	17	9	20	19,5	0,2	30,3	11,0	▲
DGM.9.20.2000.10.0	DG20	17	9	20	19,5	1,0	30,3	11,0	▲

▲ ab Lager / on stock Δ 4 Wochen / 4 weeks x auf Anfrage / upon request

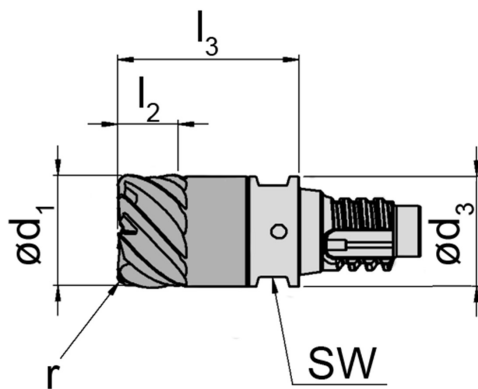
● empfohlen / recommended

o bedingt einsetzbar / alternative recommendation

- nicht geeignet / not suitable

■ unbeschichtete HM-Sorten / uncoated grades

■ beschichtete HM-Sorten / coated grades

■ bestückt/Cermet / brazed/Cermet

Abmessungen in mm



Dimensions in mm

P	•
M	•
K	•
N	-
S	•
H	○

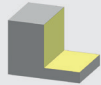
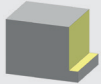
HM-Sorten  
Carbide grades

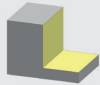
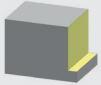
	 vc = m/min	 vc = m/min
P1.1	140	170
P1.2	140	170
P1.3	130	160
P2.1	120	140
P2.2	120	140
P2.3	120	140
P3.1	100	120
P3.2	90	110
M1.1	80	100
M2.1	60	70
M3.1	50	60

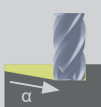
	 vc = m/min	 vc = m/min
K1.1	120	140
K1.2	100	120
K2.1	100	120
K2.2	90	110
K3.1	70	80
K3.2	60	70
S1	55	70
S2	40	50
S3	30	40
-	-	-
-	-	-

$d_1$	 $\alpha$						
		$f_z$	$a_e$	$a_p$	$f_z$	$a_e$	$a_p$
10	2°	0,04	1,0	5,0	0,06	0,20	5,00
10	2°	0,04	1,0	5,0	0,06	0,20	5,00
12	2°	0,05	1,2	6,0	0,08	0,24	6,00
12	2°	0,05	1,2	6,0	0,08	0,24	6,00
16	2°	0,07	1,6	8,0	0,11	0,32	8,00
16	2°	0,07	1,6	8,0	0,11	0,32	8,00
20	2°	0,10	2,0	10,0	0,17	0,40	10,00
20	2°	0,10	2,0	10,0	0,17	0,40	10,00

Abmessungen in mm  
Dimensions in mm



### Schneidkopf

#### Cutter Head

## DGK

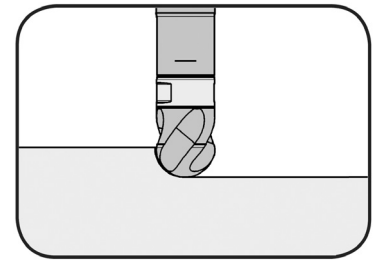

Kugelfräser 180°  
Ballnose milling head 180°

für Fräseschaft  
for Milling shank

Typ MDG  
Type

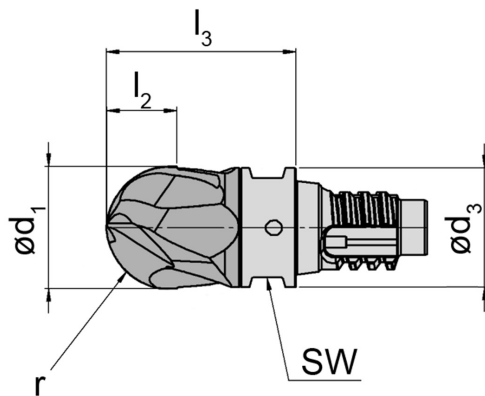

Stirnschneide über Mitte  
schneidend  
face cutting edge cutting  
across centre

Abbildung = rechtsschneidend  
Picture = right hand cutting version

Bestellnummer Part number	System System	SW	Z	d <sub>1</sub>	d <sub>3</sub>	r	l <sub>3</sub>	l <sub>2</sub>	AN2P
DGK.2.10.1000.00	DG10	8	2	10	9,8	5	16,8	5,5	▲
DGK.4.10.1000.00	DG10	8	4	10	9,8	5	16,8	5,5	▲
DGK.2.12.1200.00	DG12	10	2	12	11,7	6	19,3	6,5	▲
DGK.4.12.1200.00	DG12	10	4	12	11,7	6	19,3	6,5	▲
DGK.2.16.1600.00	DG16	13	2	16	15,6	8	24,8	8,5	▲
DGK.4.16.1600.00	DG16	13	4	16	15,6	8	24,8	8,5	▲
DGK.2.20.2000.00	DG20	17	2	20	19,5	10	30,3	12,0	▲
DGK.4.20.2000.00	DG20	17	4	20	19,5	10	30,3	12,0	▲

▲ ab Lager / on stock Δ 4 Wochen / 4 weeks x auf Anfrage / upon request

● empfohlen / recommended

o bedingt einsetzbar / alternative recommendation

- nicht geeignet / not suitable

■ unbeschichtete HM-Sorten / uncoated grades

■ beschichtete HM-Sorten / coated grades



■ bestückt/Cermet / brazed/Cermet



Abmessungen in mm

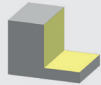

Dimensions in mm

P	●
M	●
K	○
N	○
S	○
H	○

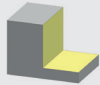
HM-Sorten  
Carbide grades

	 $vc = m/min$	 $vc = m/min$
P1.1	140	170
P1.2	140	170
P1.3	130	160
P2.1	120	140
P2.2	120	140
P2.3	120	140
P3.1	100	120
P3.2	90	110
M1.1	80	100
M2.1	60	70
M3.1	50	60

	 $vc = m/min$	 $vc = m/min$
K1.1	120	140
K1.2	100	120
K2.1	100	120
K2.2	90	110
K3.1	70	80
K3.2	60	70
S1	55	70
S2	40	50
S3	30	40
-	-	-
-	-	-

$d_1$							
		$f_z$	$a_e$	$a_p$	$f_z$	$a_e$	$a_p$
10	5°	0,08	3	3	0,09	0,10	0,50
10	4°	0,05	3	3	0,07	0,10	0,50
12	5°	0,09	4	4	0,10	0,12	0,60
12	4°	0,06	4	4	0,08	0,12	0,60
16	5°	0,11	5	5	0,13	0,16	0,80
16	4°	0,08	5	5	0,11	0,16	0,80
20	5°	0,13	6	6	0,15	0,20	1,00
20	4°	0,10	6	6	0,13	0,20	1,00

Abmessungen in mm  
Dimensions in mm



### Schneidkopf

#### Cutter Head

## DGVZ

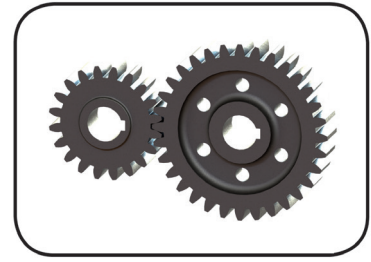

Schneidkopf Vollradius, konisch  
Cutter head conical ball nose

für Fräaserschaft  
for Milling shank

Typ MDG  
Type



Abbildung = rechtsschneidend  
Picture = right hand cutting version

Stirnschneide über Mitte  
schneidend  
face cutting edge cutting  
across centre

Bestellnummer Part number	System System	SW	Z	Ds	d <sub>3</sub>	r	l <sub>3</sub>	d <sub>1</sub>	l <sub>2</sub>		AN2P
<b>DGVZ.4.10.35.15.00</b>	DG10	8	4	10	9,8	1,5	21	2,86	12,30		▲
<b>DGVZ.4.12.35.20.00</b>	DG12	10	4	12	11,7	2,0	24	3,82	14,30		▲
<b>DGVZ.6.16.35.30.00</b>	DG16	13	6	16	15,6	3,0	32	5,72	18,40		▲
<b>DGVZ.6.20.35.50.00</b>	DG20	17	6	20	19,5	5,0	37	9,54	20,09		▲

▲ ab Lager / on stock Δ 4 Wochen / 4 weeks x auf Anfrage / upon request

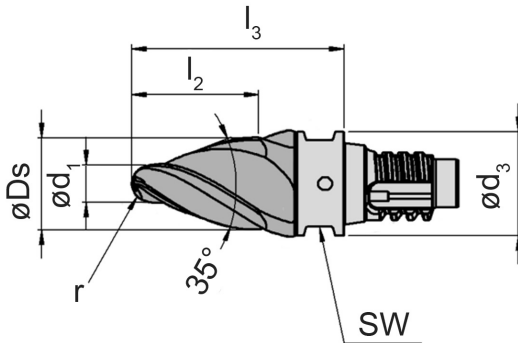
● empfohlen / recommended

o bedingt einsetzbar / alternative recommendation

- nicht geeignet / not suitable

■ unbeschichtete HM-Sorten / uncoated grades

■ beschichtete HM-Sorten / coated grades

■ bestückt/Cermet / brazed/Cermet

Abmessungen in mm

Dimensions in mm

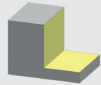
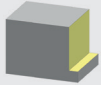

P	●
M	●
K	○
N	○
S	○
H	○

HM-Sorten  
Carbide grades

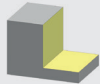
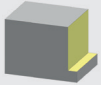
	 vc = m/min	 vc = m/min
P1.1	140	170
P1.2	140	170
P1.3	130	160
P2.1	120	140
P2.2	120	140
P2.3	120	140
P3.1	100	120
P3.2	90	110
M1.1	80	100
M2.1	60	70
M3.1	50	60

	 vc = m/min	 vc = m/min
K1.1	120	140
K1.2	100	120
K2.1	100	120
K2.2	90	110
K3.1	70	80
K3.2	60	70
S1	55	70
S2	40	50
S3	30	40
-	-	-
-	-	-

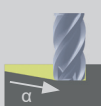

Ds	 $\alpha$						
		$f_z$	$a_e$	$a_p$	$f_z$	$a_e$	$a_p$
10	4°	0,06	1,0	5,0	0,11	0,20	5,00
12	4°	0,06	1,0	5,0	0,11	0,20	5,00
16	2°	0,05	1,2	6,0	0,09	0,24	6,00
20	2°	0,05	1,2	6,0	0,09	0,24	6,00

Abmessungen in mm  
Dimensions in mm

# Fasen Chamfering



## Schneidkopf Cutter Head

# DGFF

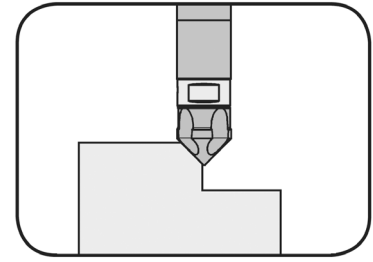

Faswinkel                      Angle of chamfer                      45 °

für Fräseschaft  
for Milling shank

Typ            MDG  
Type

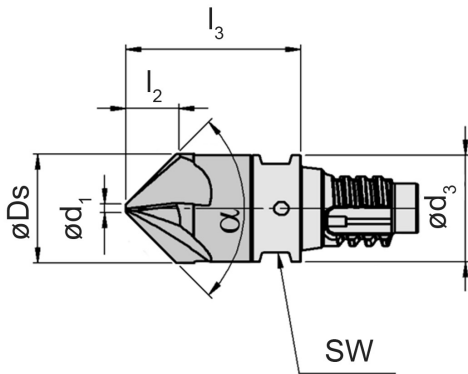

nicht stirnschneidend  
not face cutting

Abbildung = rechtsschneidend  
Picture = right hand cutting version

Bestellnummer Part number	System System	SW	Z	Ds	d <sub>3</sub>	l <sub>3</sub>	l <sub>2</sub>	d <sub>1</sub>		AN2P
DGFF.3.10.45.00	DG10	8	3	10	9,8	16,8	4,0	2		▲
DGFF.4.10.45.00	DG10	8	4	10	9,8	16,8	4,5	1		▲
DGFF.3.12.45.00	DG12	10	3	12	11,7	19,3	5,0	2		▲
DGFF.4.12.45.00	DG12	10	4	12	11,7	19,3	5,5	1		▲
DGFF.3.16.45.00	DG16	13	3	16	15,6	24,8	7,0	2		▲
DGFF.6.16.45.00	DG16	13	6	16	15,6	24,8	7,5	1		▲

▲ ab Lager / on stock    Δ 4 Wochen / 4 weeks    x auf Anfrage / upon request

● empfohlen / recommended

o bedingt einsetzbar / alternative recommendation

- nicht geeignet / not suitable

■ unbeschichtete HM-Sorten / uncoated grades

■ beschichtete HM-Sorten / coated grades

■ bestückt/Cermet / brazed/Cermet

Abmessungen in mm

Dimensions in mm

P	●
M	●
K	○
N	○
S	○
H	○

HM-Sorten  
Carbide grades

# Schnittdaten DGFF



## Cutting Data DGFF

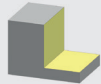
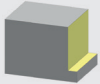

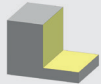
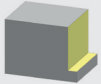
	 vc = m/min	 vc = m/min
P1.1	140	170
P1.2	140	170
P1.3	130	160
P2.1	120	140
P2.2	120	140
P2.3	120	140
P3.1	100	120
P3.2	90	110
M1.1	80	100
M2.1	60	70
M3.1	50	60

	 vc = m/min	 vc = m/min
K1.1	120	140
K1.2	100	120
K2.1	100	120
K2.2	90	110
K3.1	70	80
K3.2	60	70
S1	55	70
S2	40	50
S3	30	40
-	-	-
-	-	-



Ds						
	$f_z$	$a_e$	$a_p$	$f_z$	$a_e$	$a_p$
10	0,05	2,5	2,5	0,14	0,25	0,25
10	0,04	2,5	2,5	0,10	0,25	0,25
12	0,05	3,0	3,0	0,15	0,30	0,30
12	0,04	3,0	3,0	0,11	0,30	0,30
16	0,06	4,0	4,0	0,18	0,40	0,40
16	0,04	4,0	4,0	0,10	0,40	0,40

Abmessungen in mm  
Dimensions in mm



# Viertelrund-Profilfräsen

## Corner Rounding



### Schneidkopf

### Cutter Head

## DGV

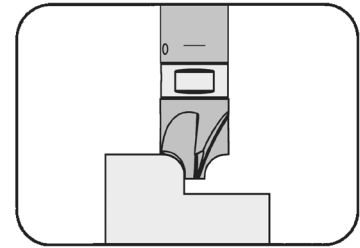

Radius konkav      Radius concave      0,2-3 mm

für Fräaserschaft  
for Milling shank

Typ      MDG  
Type

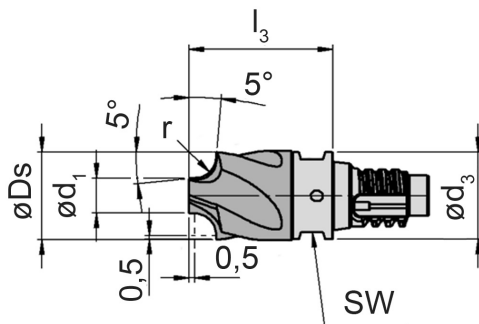

nicht stirnschneidend  
not face cutting

Abbildung = rechtsschneidend  
Picture = right hand cutting version

Bestellnummer Part number	System System	SW	Z	Ds	d <sub>3</sub>	r	l <sub>3</sub>	d <sub>1</sub>	AN2P
<b>DGV.4.10.R020.00</b>	DG10	8	4	10	9,8	0,20	16,8	8,6	▲
<b>DGV.4.10.R050.00</b>	DG10	8	4	10	9,8	0,50	16,8	8,0	▲
<b>DGV.4.10.R100.00</b>	DG10	8	4	10	9,8	1,00	16,8	7,0	▲
<b>DGV.4.10.R125.00</b>	DG10	8	4	10	9,8	1,25	16,8	6,5	▲
<b>DGV.4.10.R150.00</b>	DG10	8	4	10	9,8	1,50	16,8	6,0	▲
<b>DGV.4.10.R200.00</b>	DG10	8	4	10	9,8	2,00	16,8	5,0	▲
<b>DGV.4.10.R250.00</b>	DG10	8	4	10	9,8	2,50	16,8	4,0	▲
<b>DGV.4.10.R300.00</b>	DG10	8	4	10	9,8	3,00	16,8	3,0	▲

▲ ab Lager / on stock    Δ 4 Wochen / 4 weeks    x auf Anfrage / upon request

● empfohlen / recommended

o bedingt einsetzbar / alternative recommendation

- nicht geeignet / not suitable

■ unbeschichtete HM-Sorten / uncoated grades

■ beschichtete HM-Sorten / coated grades

■ bestückt/Cermet / brazed/Cermet

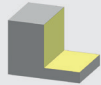
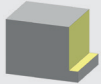

P	●
M	●
K	○
N	○
S	○
H	○

HM-Sorten  
Carbide grades

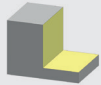
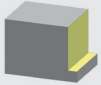
		
	vc = m/min	vc = m/min
P1.1	140	170
P1.2	140	170
P1.3	130	160
P2.1	120	140
P2.2	120	140
P2.3	120	140
P3.1	100	120
P3.2	90	110
M1.1	80	100
M2.1	60	70
M3.1	50	60

		
	vc = m/min	vc = m/min
K1.1	120	140
K1.2	100	120
K2.1	100	120
K2.2	90	110
K3.1	70	80
K3.2	60	70
S1	55	70
S2	40	50
S3	30	40
-	-	-
-	-	-



Ds						
	f <sub>z</sub>	a <sub>e</sub>	a <sub>p</sub>	f <sub>z</sub>	a <sub>e</sub>	a <sub>p</sub>
10	0,08	0,20	0,20	0,10	0,20	0,20
10	0,07	0,50	0,50	0,10	0,25	0,25
10	0,06	1,00	1,00	0,10	0,25	0,25
10	0,05	1,25	1,25	0,10	0,25	0,25
10	0,05	1,50	1,50	0,10	0,25	0,25
10	0,04	2,00	2,00	0,10	0,25	0,25
10	0,04	2,50	2,50	0,10	0,25	0,25
10	0,04	3,00	3,00	0,10	0,25	0,25

Abmessungen in mm  
Dimensions in mm



# Toodle-Schnelllaufspindeln

Toodle high speed spindle

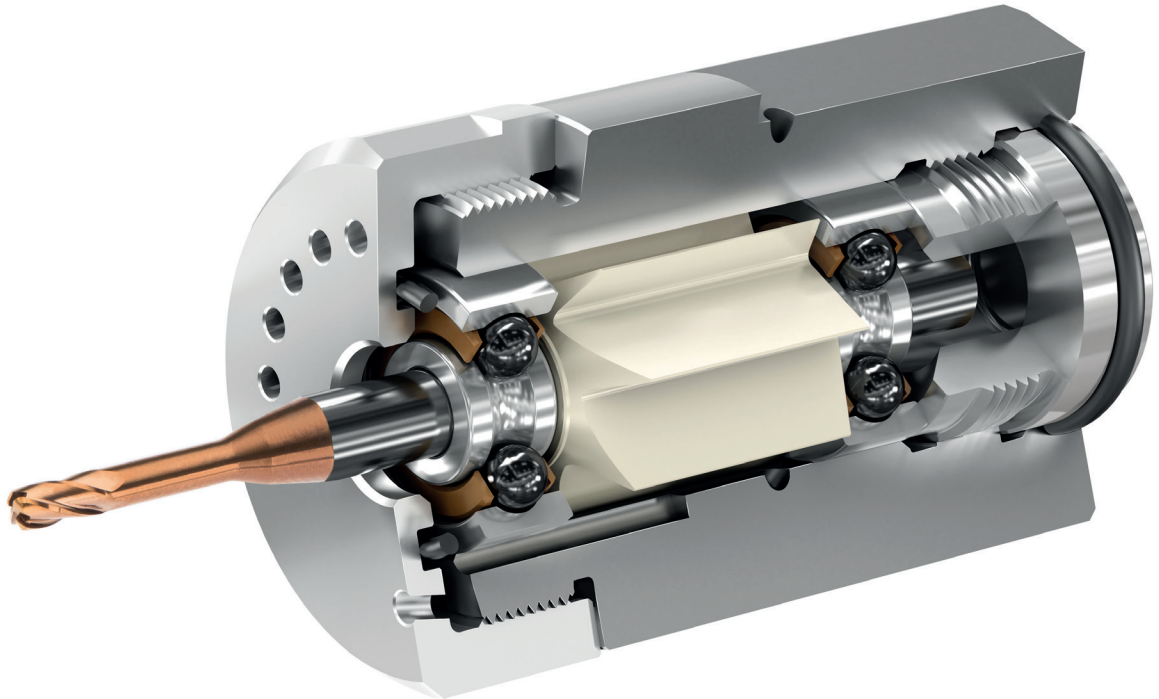

D

**Hochgenaues Fräsen von  
0,1 - 3,0 mm Durchmesser,  
für DS-Fräser**

**High-precision milling from  
diameters of 0,1 - 3,0 mm,  
for DS end mills**

Schnelllaufspindeln  
High Speed Spindles  
TB131 / TB131-90 /  
TG131

Seite/Page  
D4

Zubehör  
Additional Equipment

Seite/Page  
D5

Drehzahlen und  
Kühlmitteldruck  
Rotation Speed and  
Coolant Pressure

Seite/Page  
D6

Montageanleitung  
Assembly Instruction

Seite/Page  
D7

Über 600 Mikrofräser sind als Standard innerhalb einer Woche vormontiert lieferbar.  
Dabei ändert sich die Artikelnummer von **“DS....”** in **“TS....”**  
Bestellbeispiel: DSTH.4.120.020.015 wird TSTH.4.120.020.015

More than 600 Micro pre-mounted end mills are available as standard within one week.  
This changes the part number from **“DS....”** into **“TS....”**  
Ordering example: DSTH.4.120.020.015 becomes TSTH.4.120.020.015



## Toodle-Schnellaufspindeln für DS-Fräser

Mehr als 600 DS-Fräser mit Schneidkreisdurchmessern von 0,1 – 3 mm können mit vormontierter Toodle-Spindel innerhalb einer Woche geliefert werden. Dabei lassen sich die Fräser nicht nur hinsichtlich des Durchmessers auf den Bedarfsfall abstimmen. Dank der zahlreichen Varianten mit verschiedenen Geometrien, Beschichtungen und Hartmetallsubstraten kann das am besten geeignete Werkzeug zum Bearbeiten von NE-Metallen, Stählen, gehärteten Stählen, Titanlegierungen sowie anderen schwer zerspanbaren Werkstoffen ausgewählt werden.

Die Schnellaufspindeln lassen sich problemlos in Standard-Werkzeugaufnahmen wie Hydrodehn-, Spannzangen- und Weldonfutter sowie in Bohrstangenhaltern spannen.

## Toodle high-speed spindles for DS milling cutters

More than 600 DS milling cutters with cutting edge diameters of between 0.1 and 3 mm can be supplied with a pre-mounted Toodle spindle within one week. The milling cutters can be adapted to meet specific requirements more than simply in terms of their diameter. Thanks to the numerous versions with various geometries, coatings and carbide substrates, the tool best suited to the job can be selected for machining non-ferrous metals, steels, hardened steels, titanium alloys as well as other hard-to-cut materials.

The high-speed spindles can be clamped with ease in standard tool holders, such as hydraulic expansion chucks, collet chucks and Weldon shank adapters, as well as in boring bar holders.



**TB131**

Emulsion, Öl  
Emulsion, Oil

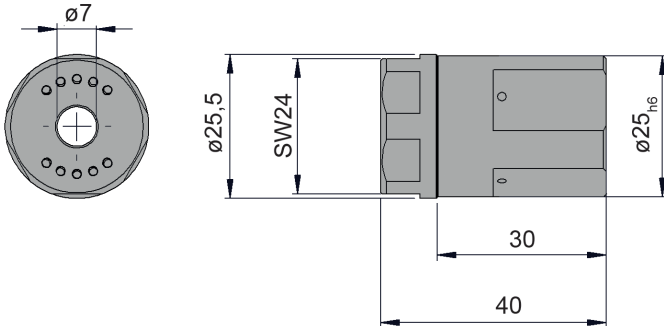

**TB131-90**

Emulsion, Öl  
Emulsion, Oil

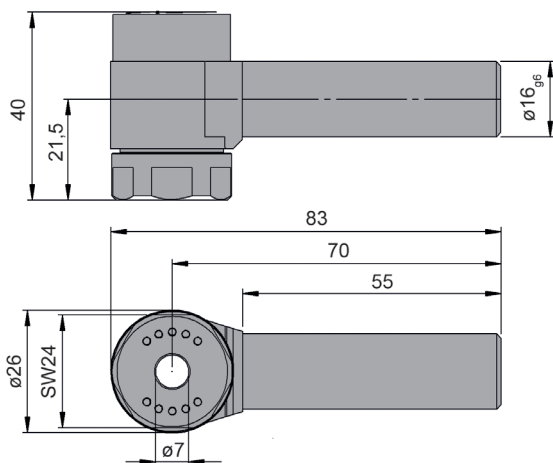

**TG131**

Druckluft geölt  
Air mist

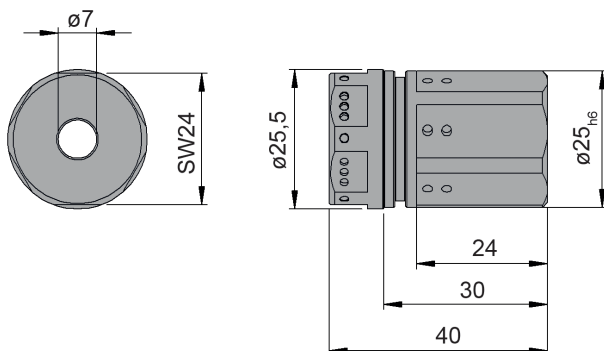

D



Austauschsatz  
Assembly kit

Schaftdurchmesser  
Shank diameter

**RK13M3**    Ø 3 mm  
**RK13M4**    Ø 4 mm  
**RK13M6**    Ø 6 mm



Montagesatz  
Assembly kit

Schaftdurchmesser  
Shank diameter

**AK13M3**    Ø 3 mm  
**AK13M4**    Ø 4 mm  
**AK13M6**    Ø 6 mm



Druckmanometer  
Pressure Manometer

**PK25**



**D**



## Drehzahl / Kühlmitteldruck Toodle Blue TB131 & TB131-90

Rotation Speed / Emulsion Pressure

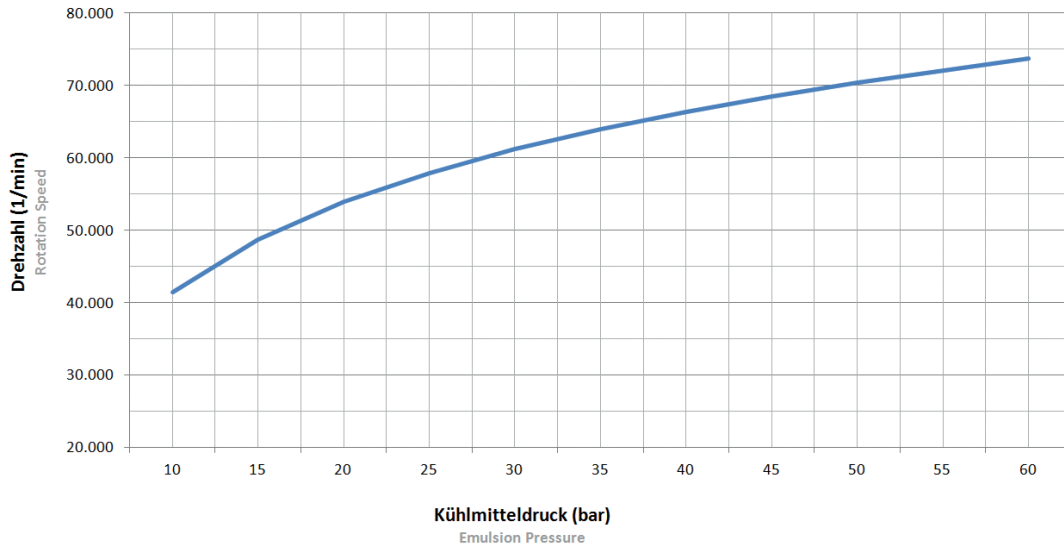

## Drehzahl / Luftdruck Toodle Green TG131

Rotation Speed / Air pressure

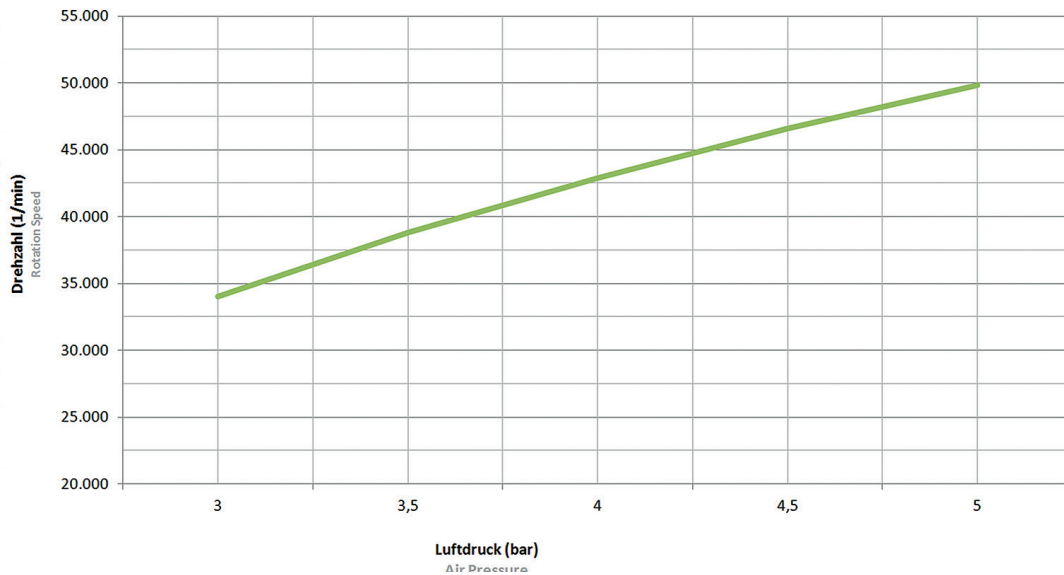

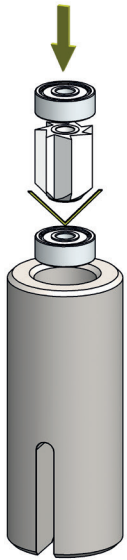

1.

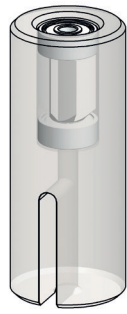

2.

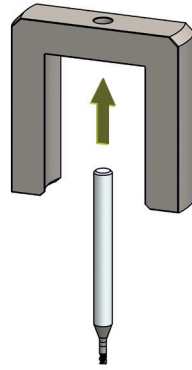

3.

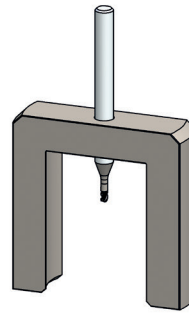

4.

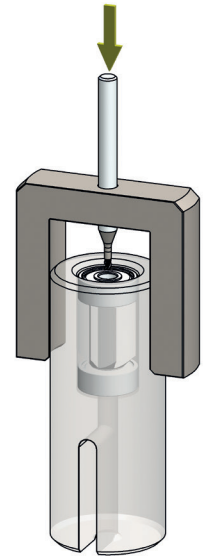

5.

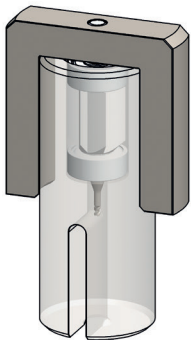

6.

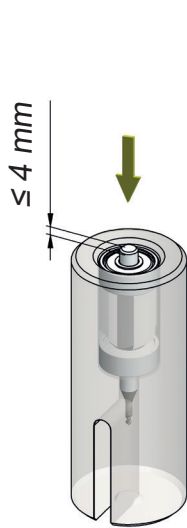

7.

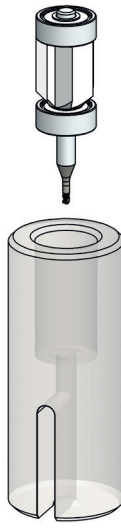

8.

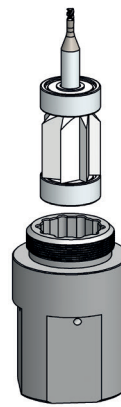

9.

5-10 Nm

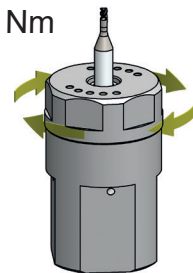

10.

Passende Spannmittel finden Sie in unserem Katalog  
„Bohren und Reiben“.

For suitable toolholders please see our catalogue  
„Drilling and Reaming“





**FINDEN SIE JETZT IHRE  
PASSENDE WERKZEUGLÖSUNG.**

FIND YOUR RIGHT  
TOOLING SOLUTION NOW.

**[www.phorn.de](http://www.phorn.de)**

**DEUTSCHLAND, STAMMSITZ**

GERMANY, HEADQUARTERS

—

Hartmetall Werkzeugfabrik

Paul Horn GmbH

Horn-Straße 1

D-72072 Tübingen

Tel +49 7071 / 70040

Fax +49 7071 / 72893

[info@phorn.de](mailto:info@phorn.de)

[www.phorn.de](http://www.phorn.de)

**Find your country:**

**[www.phorn.com/countries](http://www.phorn.com/countries)**